

# FIBRE CHANNEL

## LINK SERVICES

(FC-LS-4)

REV 4.00

INCITS working draft proposed  
American National Standard  
for Information Technology

September 25, 2017

Secretariat: Information Technology Industry Council

### NOTE:

This is a working draft American National Standard of Accredited Standards Committee INCITS. As such this is not a completed standard. The T11 Technical Committee or anyone else may modify this document as a result of comments received anytime, or during a future public review and its eventual approval as a Standard. Use of the information contained herein is at your own risk.

Permission is granted to members of INCITS, its technical committees, and their associated task groups to reproduce this document for the purposes of INCITS standardization activities without further permission, provided this notice is included. All other rights are reserved. Any duplication of this document for commercial or for-profit use is strictly prohibited.

### POINTS OF CONTACT:

Steve Wilson (T11 Chair) Brocade Communications 130 Holger Way San Jose, CA 95134 408-333-8128 swilson@brocade.com	Craig W. Carlson (T11 Vice Chair and T11.3 Chair) QLogic Corporation 12701 Whitewater Drive Minnetonka, MN 55343 952-687-2431 craig.carlson@qlogic.com
---	--

Louis Ricci (FC-LS-4 Chair) EMC 5 Spruce Road Hyde Park, NY 12538 845-705-8884 louis.ricci@emc.com	Craig W. Carlson (FC-LS-4 Editor) QLogic Corporation 12701 Whitewater Drive Minnetonka, MN 55343 952-687-2431 craig.carlson@qlogic.com
---	---

Release Notes for revision 4.00:

- Incorporated T11/16-427v1.
- Incorporated T11/16-399v1.
- Incorporated T11-2017-00095-v002.

**BSR INCITS 553-20xx**

American National Standard  
for Information Technology

**Fibre Channel —  
Link Services - 4 (FC-LS-4)**

Secretariat

**Information Technology Industry Council**

Approved (not yet approved)

**American National Standards Institute, Inc.**

**Abstract**

This standard describes the Link Services requirements. The Physical Interface requirements are described in Fibre Channel-Physical Interfaces - 5 (FC-PI-5). The Framing and Signaling requirements are described in Fibre Channel-Physical Framing and Signaling - 3 (FC-FS-4). This standard is recommended for new implementations but does not obsolete the existing Fibre Channel standards.

# American National Standard

Approval of an American National Standard requires review by ANSI that the requirements for due process, consensus, and other criteria for approval have been met by the standards developer.

Consensus is established when, in the judgement of the ANSI Board of Standards Review, substantial agreement has been reached by directly and materially affected interests. Substantial agreement means much more than a simple majority, but not necessarily unanimity. Consensus requires that all views and objections be considered, and that a concerted effort be made towards their resolution.

The use of American National Standards is completely voluntary; their existence does not in any respect preclude anyone, whether he has approved the standards or not, from manufacturing, marketing, purchasing, or using products, processes, or procedures not conforming to the standards. The American National Standards Institute does not develop standards and will in no circumstances give an interpretation of any American National Standard. Moreover, no person shall have the right or authority to issue an interpretation of an American National Standard in the name of the American National Standards Institute. Requests for interpretations should be addressed to the secretariat or sponsor whose name appears on the title page of this standard.

**CAUTION NOTICE:** This American National Standard may be revised or withdrawn at any time. The procedures of the American National Standards Institute require that action be taken periodically to reaffirm, revise, or withdraw this standard. Purchasers of American National Standards may receive current information on all standards by calling or writing the American National Standards Institute.

The user's attention is called to the possibility that compliance with this standard may require use of an invention covered by patent rights. As of the date of publication of this standard, following calls for the identification of patents that may be required for the implementation of the standard, notice of one or more such claims has been received.

By publication of this standard, no position is taken with respect to the validity of any such claim(s) or of any patent rights in connection therewith. If a patent holder has filed a statement of willingness to grant a license under these rights on reasonable and nondiscriminatory terms and conditions to applicants desiring to obtain such a license, then details may be obtained from the standards developer.

Published by

**American National Standards Institute  
11 West 42nd Street, New York, NY 10036**

Copyright © 20xx by Information Technology Industry Council (ITI)  
All rights reserved.

No part of this publication may be reproduced in any form, in an electronic retrieval system or otherwise, without prior written permission of ITI, 1101 K Street NW, Suite 610 Washington, DC 20005.

Printed in the United States of America

**Foreword** (This Foreword is not part of American National Standard INCITS 553-20xx.)

The Fibre Channel Link Services (FC-LS-3) standard describes in detail the Fibre Channel Link Services introduced in FC-FS-4. In addition, this document describes any ancillary functions and services required to support the Fibre Channel Link Services.

This standard was developed by the INCITS Fibre Channel T11 Technical Committee of Accredited Standards Committee INCITS during 2003-20xx. The standards approval process started in 20xx. This document includes annexes which are informative and are not considered part of the standard.

Requests for interpretation, suggestions for improvements or addenda, or defect reports are welcome. They should be sent to the INCITS Secretariat, Information Technology Industry Council, 1101 K Street, NW Suite 610 Washington, DC 20005.

This standard was processed and approved for submittal to ANSI by the International Committee for Information Technology Standards (INCITS). Committee approval of the standard does not necessarily imply that all committee members voted for approval.

At the time it approved this standard, INCITS had the following members:

*(to be filled in by INCITS)*

Technical Committee T11 on Fibre Channel Interfaces, which reviewed this standard, had the following voting members:

Steve Wilson, Chair

Craig W. Carlson, Vice-Chair

Richard Johnson, Secretary

Company	Name
---------	------

Task Group T11.3 on Fibre Channel Protocols, which developed and reviewed this standard, had the following voting members:

Craig W. Carlson, Chair  
, Vice-Chair  
Patty Driever, Secretary

Company	Name
---------	------

## **Introduction**

FC-LS-4 is one of the Fibre Channel family of standards. This family includes INCITS 488:2016, FC-FS-4, which specifies the Framing and Signalling Interface. INCITS 511:2016, FC-SW-6, is related to Fabric requirements. INCITS 332:1999, FC-AL-2, specifies the arbitrated loop topology.

FC-LS-4 defines requests and replies that comprise the set of Fibre Channel Extended Link Services (ELSs).



<b>Contents</b>	<b>Page</b>
<b>1 Scope</b> .....	<b>1</b>
<b>2 Normative References</b> .....	<b>1</b>
2.1 Overview .....	1
2.2 Approved references .....	1
2.3 References under development .....	2
2.4 Other references .....	2
<b>3 Definitions and conventions</b> .....	<b>4</b>
3.1 Overview .....	4
3.2 Definitions .....	4
3.3 Editorial Conventions .....	15
3.4 State Machine notation .....	16
3.5 Abbreviations and acronyms .....	17
3.6 Symbols .....	18
3.7 Keywords .....	19
3.8 T10 Vendor ID fields .....	20
<b>4 Extended Link Services</b> .....	<b>21</b>
4.1 Introduction .....	21
4.2 Link Service tag, length, value (TLV) descriptors .....	22
4.2.1 Overview .....	22
4.2.2 Link Service request with Link Service TLV descriptor payload example .....	22
4.2.3 Link Service accept with Link Service TLV descriptor payload example .....	23
4.2.4 Link Service TLV descriptors .....	24
4.3 Extended Link Service requests .....	25
4.3.1 Introduction .....	25
4.3.2 Sequence and Exchange management .....	29
4.3.3 Advise Credit (ADVC) .....	30
4.3.4 Echo (ECHO) .....	33
4.3.5 Estimate Credit (ESTC) .....	34
4.3.6 Establish Streaming (ESTS) .....	35
4.3.7 Login (FLOGI/PLOGI) .....	37
4.3.8 Logout (LOGO) .....	37
4.3.9 Read Link Error Status Block (RLS) .....	39
4.3.10 Read Timeout Value (RTV) .....	40
4.3.11 Reinstate Recovery Qualifier (RRQ) .....	41
4.3.12 Request Sequence Initiative (RSI) .....	43
4.3.13 Test (TEST) .....	45
4.3.14 Fabric Address Notification (FAN) .....	46
4.3.15 Loop Initialize (LINIT) .....	47
4.3.16 Loop Status (LSTS) .....	48
4.3.17 Registered State Change Notification (RSCN) .....	50
4.3.18 State Change Registration (SCR) .....	55
4.3.19 Process Login (PRLI) .....	57
4.3.20 Process logout (PRLO) .....	61
4.3.21 Test Process Login State (TPLS) .....	65
4.3.22 Request Node Identification Data (RNID) .....	68
4.3.23 Registered Link Incident Report (RLIR) .....	76
4.3.24 Link Incident Record Registration (LIRR) .....	83
4.3.25 Discover N_Port/Service Parameters (PDISC) .....	86
4.3.26 Discover F_Port Service Parameters (FDISC) .....	86

4.3.27	Discover Address (ADISC)	87
4.3.28	Third Party Process Logout (TPRLO)	90
4.3.29	Clock Synchronization Request (CSR)	92
4.3.30	Clock Synchronization Update (CSU)	96
4.3.31	Report Port Buffer Conditions (RPBC)	97
4.3.32	Report node FC-4 Types (RNFT)	98
4.3.33	Scan Remote Loop (SRL)	100
4.3.34	Set Bit-error Reporting Parameters (SBRP)	102
4.3.35	Query Security Attributes (QSA) Version 2	105
4.3.36	Report Port Speed Capabilities (RPSC)	107
4.3.37	Read Exchange Concise (REC)	109
4.3.38	Exchange Virtual Fabrics Parameters (EVFP)	111
4.3.39	Link Keep Alive (LKA)	118
4.3.40	Link Cable Beacon (LCB)	119
4.3.41	Registered Fabric Change Notification (RFCN)	121
4.3.42	Define FFI Domain Topology Map (FFI_DTM)	122
4.3.43	Request FFI Domain Topology Map (FFI_RTM)	124
4.3.44	FFI AE Principal Switch Selector (FFI_PSS)	125
4.3.45	FFI Map Update Registration (FFI_MUR)	126
4.3.46	FFI Registered Map Update Notification (FFI_RMUN)	128
4.3.47	FFI Suspend Map Updates (FFI_SMU)	129
4.3.48	FFI Resume Map Updates (FFI_RMU)	130
4.3.49	Read Diagnostic Parameters (RDP)	131
4.3.49	Query Fabric Priority Allocation (QFPA)	143
4.3.50	Update VE Mappings (UVEM)	145
4.4	Extended Link Service Reply Sequences	147
4.4.1	Overview	147
4.4.2	LS_ACC	148
4.4.3	Reply Sequence	148
4.4.4	Link Service Reject (LS_RJT)	148
<b>5</b>	<b>FC-4 Link Service</b>	<b>153</b>
<b>6</b>	<b>Login and Service Parameters</b>	<b>154</b>
6.1	Introduction	154
6.2	Fabric Login	154
6.2.1	Introduction	154
6.2.2	Explicit Fabric Login Procedure	155
6.2.3	SOFs	157
6.2.4	Frequency	157
6.2.5	Fabric Login completion - Originator	158
6.2.6	Fabric Login completion - Responder	158
6.3	N_Port Login	158
6.3.1	Introduction	158
6.3.2	Explicit N_Port Login	159
6.3.3	SOFs	162
6.3.4	Frequency	162
6.3.5	N_Port Login completion - Originator	162
6.3.6	N_Port Login completion - Responder	162
6.4	Logout	163
6.4.1	Introduction	163
6.4.2	Explicit N_Port Logout Procedure	163
6.4.3	Explicit Fabric Logout Procedure	163
6.4.4	Implicit Logout	164

6.4.5	The effects of FLOGI, FDISC, and LOGO	165
6.5	Extended Login Processing	166
6.6	Service Parameters	167
6.6.1	ELS and LS_ACC Payload	167
6.6.2	Common Service Parameters	169
6.6.3	Port_Name	179
6.6.4	Node_ or Fabric_Name	179
6.6.5	Class Service Parameters	180
6.6.6	Auxiliary Parameter Data	192
6.6.7	Vendor Version Level	194
6.6.8	Services Availability	194
6.6.9	Login Extension	195
6.6.10	Clock Synchronization Quality of Service	196
<b>7</b>	<b>Process Login/Logout</b>	<b>201</b>
7.1	Process Login	201
7.1.1	Introduction	201
7.1.2	Mode of operation	202
7.2	Process Logout	203
<b>8</b>	<b>Virtual Fabrics PN_Port Support</b>	<b>205</b>
8.1	Overview	205
8.2	Enabling VFT Tagging on PN_Ports	205
8.3	Configuration Information	208
8.4	Exchange Virtual Fabrics Parameters Processing	208
8.4.1	Overview	208
8.4.2	Changing the VFT Tagging Mode	211
8.4.3	Adding or Removing Virtual Fabrics	211
8.4.4	Changing the Port VF_ID	212
<b>9</b>	<b>Priority Tagging</b>	<b>213</b>
9.1	Overview	213
9.2	Operations	214
9.3	Scalability	215

<b>Figure</b>		<b>Page</b>
Figure 1 –	State Machine Example .....	16
Figure 2 –	Illustration of parameters.....	102
Figure 3 –	LS_RJT format .....	149
Figure 4 –	Image pairs .....	201
Figure 5 –	PN_Port Initialization of Virtual Fabrics.....	206
Figure 6 –	A Generic EVFP Transaction .....	209
Figure 7 –	Example of Relationship among Local VE IDs, N_Port_IDs, and PN_Ports.....	213
Figure 8 –	Example of Priority Tagging of the Traffic of a VE .....	214

<b>Table</b>	<b>Page</b>
Table 1 – Comparison of numbering conventions . . . . .	15
Table 2 – Extended Link Services Routing Bits and Information Categories . . . . .	21
Table 3 – Link Service TLV descriptor format . . . . .	22
Table 4 – Link Service request with Link Service TLV descriptor payload example . . . . .	22
Table 5 – Link Service accept with Link Service TLV descriptor payload example . . . . .	23
Table 6 – Link Service TLV descriptors . . . . .	24
Table 7 – Link Service Request Information descriptor format . . . . .	25
Table 8 – N_Port_ID Descriptor . . . . .	25
Table 9 – ELS_Command codes . . . . .	26
Table 10 – Responses to Received ELSs . . . . .	29
Table 11 – ADVC Payload . . . . .	31
Table 12 – ADVC LS_ACC Payload . . . . .	32
Table 13 – ECHO Payload . . . . .	34
Table 14 – ECHO LS_ACC Payload . . . . .	34
Table 15 – ESTC Payload . . . . .	35
Table 16 – ESTS Payload . . . . .	35
Table 17 – ESTS LS_ACC Payload . . . . .	36
Table 18 – LOGO Payload . . . . .	38
Table 19 – LOGO LS_ACC Payload . . . . .	39
Table 20 – RLS Payload . . . . .	39
Table 21 – RLS LS_ACC Payload . . . . .	40
Table 22 – RTV Payload . . . . .	41
Table 23 – RTV LS_ACC Payload . . . . .	41
Table 24 – RRQ Payload . . . . .	43
Table 25 – RRQ LS_ACC Payload . . . . .	43
Table 26 – RSI Payload . . . . .	44
Table 27 – RSI LS_ACC Payload . . . . .	45
Table 28 – TEST Payload . . . . .	45
Table 29 – FAN Payload . . . . .	46
Table 30 – LINIT Payload . . . . .	47
Table 31 – Initialization Function . . . . .	47
Table 32 – LINIT LS_ACC Payload . . . . .	48
Table 33 – LINIT Status . . . . .	48
Table 34 – LSTS Payload . . . . .	48
Table 35 – LSTS LS_ACC Payload . . . . .	49
Table 36 – Loop State . . . . .	50
Table 37 – RSCN Payload . . . . .	52
Table 38 – Generic affected Port_ID page . . . . .	53
Table 39 – RSCN Event Qualifier values . . . . .	54
Table 40 – Address Format . . . . .	55
Table 41 – RSCN LS_ACC Payload . . . . .	55
Table 42 – SCR Payload . . . . .	56
Table 43 – Registration Function Bitmap . . . . .	56
Table 44 – SCR LS_ACC Payload . . . . .	57
Table 45 – PRLI Payload . . . . .	57
Table 46 – PRLI service parameter page format . . . . .	58
Table 47 – PRLI LS_ACC Payload . . . . .	59
Table 48 – PRLI LS_ACC service parameter response page format . . . . .	60
Table 49 – PRLI accept response code . . . . .	61
Table 50 – PRLO Payload . . . . .	62
Table 51 – PRLO logout parameter page format . . . . .	62
Table 52 – PRLO LS_ACC Payload . . . . .	63

Table 53 – PRLO LS_ACC logout parameter response page format . . . . .	64
Table 54 – PRLO accept response code . . . . .	65
Table 55 – TPLS Payload . . . . .	66
Table 56 – TPLS image pair ID page format. . . . .	66
Table 57 – TPLS LS_ACC Payload . . . . .	67
Table 58 – TPLS response page format . . . . .	67
Table 59 – TPLS accept response code . . . . .	68
Table 60 – RNID Payload . . . . .	69
Table 61 – Node Identification Data Format . . . . .	69
Table 62 – RNID Accept Payload . . . . .	70
Table 63 – Node Identification Data Format . . . . .	70
Table 64 – VN_Port Phy Type. . . . .	71
Table 65 – Common Identification Data . . . . .	71
Table 66 – General Topology Specific Identification Data . . . . .	72
Table 67 – Associated Type . . . . .	73
Table 68 – Multi-function device bit definitions . . . . .	74
Table 69 – Node Management . . . . .	75
Table 70 – IP Version . . . . .	75
Table 71 – RLIR Payload . . . . .	77
Table 72 – Link Incident Record Format. . . . .	78
Table 73 – Common Link Incident Record Data . . . . .	79
Table 74 – Time Stamp Format values . . . . .	80
Table 75 – Incident Qualifier . . . . .	80
Table 76 – Incident Code values. . . . .	82
Table 77 – RLIR LS_ACC Payload . . . . .	83
Table 78 – LIRR Payload . . . . .	84
Table 79 – Registration Function . . . . .	85
Table 80 – Link Incident Record-Registration Format. . . . .	85
Table 81 – LIRR LS_ACC Payload . . . . .	86
Table 82 – ADISC Request payload . . . . .	88
Table 83 – ADISC LS_ACC Payload . . . . .	89
Table 84 – Response summary to FDISC/PDISC. . . . .	90
Table 85 – TPRLO Payload . . . . .	91
Table 86 – TPRLO logout parameter page. . . . .	91
Table 87 – TPRLO LS_ACC Payload . . . . .	92
Table 88 – CSR Payload. . . . .	93
Table 89 – CSR Clock Sync Mode Meaning. . . . .	93
Table 90 – CSR LS_ACC Payload . . . . .	94
Table 91 – CSU Clock Sync Mode Meaning. . . . .	95
Table 92 – CSU Payload. . . . .	96
Table 93 – Clock Count Field Meaning . . . . .	96
Table 94 – RPBC Payload . . . . .	97
Table 95 – ELS Buffer Parameters Field. . . . .	98
Table 96 – RPBC LS_ACC Payload . . . . .	98
Table 97 – RNFT Payload. . . . .	99
Table 98 – RNFT LS_ACC Payload . . . . .	99
Table 99 – RNFT FC-4 Entry . . . . .	100
Table 100 – SRL Payload . . . . .	101
Table 101 – Flag field definitions. . . . .	101
Table 102 – SRL LS_ACC Payload . . . . .	102
Table 103 – SBRP Payload . . . . .	103
Table 104 – SBRP LS_ACC Payload. . . . .	104
Table 105 – QSA Request Payload . . . . .	105
Table 106 – Enforced Security Attribute Registration Mask . . . . .	105

Table 107 – Extended Security Attribute Registration Mask . . . . .	106
Table 108 – QSA LS_ACC Payload . . . . .	106
Table 109 – Enforced Security Attribute Field . . . . .	106
Table 110 – Extended Security Attribute Field . . . . .	107
Table 111 – RPSC Payload . . . . .	107
Table 112 – RPSC LS_ACC Payload . . . . .	107
Table 113 – Port Speed Capabilites . . . . .	108
Table 114 – Port Operating Speed . . . . .	109
Table 115 – REC Payload. . . . .	110
Table 116 – REC LS_ACC Payload . . . . .	111
Table 117 – EVFP Request Payload. . . . .	112
Table 118 – EVFP Message Codes . . . . .	112
Table 119 – EVFP Accept Payload . . . . .	113
Table 120 – LS_RJT Reason Codes for EVFP . . . . .	113
Table 121 – EVFP_SYNC Message Payload . . . . .	114
Table 122 – Descriptor Format . . . . .	114
Table 123 – Descriptor Control Codes . . . . .	115
Table 124 – Descriptor Types . . . . .	115
Table 125 – Tagging Administrative Status Descriptor . . . . .	115
Table 126 – Administrative Tagging Modes . . . . .	116
Table 127 – Tagging Mode Negotiation . . . . .	116
Table 128 – Port VF_ID Descriptor . . . . .	116
Table 129 – Locally-Enabled VF_ID List Descriptor . . . . .	117
Table 130 – Vendor Specific Descriptor . . . . .	117
Table 131 – LKA Payload . . . . .	118
Table 132 – LKA LS_ACC Payload. . . . .	119
Table 133 – LCB Payload . . . . .	119
Table 134 – Subcommand field functions . . . . .	120
Table 135 – Capability field functions . . . . .	120
Table 136 – Status field functions . . . . .	120
Table 137 – LCB LS_ACC Payload . . . . .	121
Table 138 – RFCN Request Payload . . . . .	122
Table 139 – Change Flags . . . . .	122
Table 140 – FFI_DTM Payload . . . . .	123
Table 141 – FFI_DTM LS_ACC Payload . . . . .	123
Table 142 – FFI_RTM Payload . . . . .	124
Table 143 – FFI_RTM LS_ACC Payload . . . . .	125
Table 144 – FFI_PSS Payload . . . . .	126
Table 145 – FFI_PSS LS_ACC Payload. . . . .	126
Table 146 – FFI_MUR Payload. . . . .	127
Table 147 – Registration Function . . . . .	127
Table 148 – FFI_MUR LS_ACC Payload . . . . .	127
Table 149 – FFI_RMUN Payload . . . . .	128
Table 150 – FFI_SMU Payload . . . . .	129
Table 151 – FFI_SMU LS_ACC Payload . . . . .	130
Table 152 – FFI_RMU Payload. . . . .	130
Table 153 – FFI_RMU LS_ACC Payload . . . . .	131
Table 154 – RDP Payload. . . . .	132
Table 155 – RDP LS_ACC Payload . . . . .	133
Table 156 – Port Speed Descriptor . . . . .	134
Table 157 – Link Error Status Block Descriptor . . . . .	134
Table 158 – VN_Port Phy Type. . . . .	135
Table 159 – Port Names Descriptor . . . . .	135
Table 160 – SFP Diagnostic Parameters descriptor . . . . .	135

Table 161 – SFP Flags .....	137
Table 162 – QSFP Diagnostic Parameters descriptor .....	138
Table 163 – QSFP Flags .....	139
Table 164 – FEC Status Descriptor .....	140
Table 165 – Buffer Credit Descriptor .....	140
Table 166 – Optical Element Data Descriptor .....	141
Table 167 – Optical Element Function Flags .....	141
Table 168 – Optical Element Type Transgression Flags .....	142
Table 169 – Optical Product Data Descriptor .....	142
Table 170 – QFPA Request Payload .....	144
Table 171 – QFPA LS_ACC Payload .....	144
Table 172 – Priority Range Descriptor Format .....	144
Table 173 – UVEM Request Payload .....	146
Table 174 – VEM ID Descriptor .....	146
Table 175 – Instantiated VE Mapping Descriptor .....	146
Table 176 – Deinstantiated VE Mapping Descriptor .....	147
Table 177 – UVEM LS_ACC Payload .....	147
Table 178 – LS_RJT Reason Codes .....	149
Table 179 – LS_RJT Reason Code Explanations .....	150
Table 180 – Effects of FLOGI, FDISC, & LOGO on Permanent Port Name (PPN) .....	165
Table 181 – FLOGI, PLOGI, FDISC or LS_ACC Payload .....	168
Table 182 – Common Service Parameter applicability .....	169
Table 183 – Common Service Parameters - FLOGI .....	172
Table 184 – Common Service Parameters - PLOGI and PLOGI LS_ACC .....	173
Table 185 – Common Service Parameters - FLOGI LS_ACC .....	173
Table 186 – Clock Synchronization Applicability .....	177
Table 187 – Class Service Parameters Applicability .....	180
Table 188 – Class Service Parameters - FLOGI .....	182
Table 189 – Class Service Parameters - PLOGI and PLOGI LS_ACC .....	183
Table 190 – Class Service Parameters - FLOGI LS_ACC .....	183
Table 191 – Sequential delivery support .....	184
Table 192 – Fabric Login Priority and Preemption Support .....	185
Table 193 – Class 2 and 3 Preference Bit Function .....	186
Table 194 – Relationship between Preferred delivery and sequential delivery .....	186
Table 195 – DiffServ QoS bit definition .....	187
Table 196 – ACK_0 Support Conditions (Initiator Control) .....	188
Table 197 – ACK_0 Support Conditions (Recipient Control) .....	189
Table 198 – Error Policy Bits Definition .....	190
Table 199 – Categories per Sequence Bits Definition .....	190
Table 200 – Auxiliary Parameter Data .....	193
Table 201 – NPIV_CNT field in LS_ACC .....	193
Table 202 – Login Extension Page format .....	195
Table 203 – Page Code Definitions .....	196
Table 204 – Vendor Specific Page format .....	196
Table 205 – N_Port Clock Synchronization QoS .....	197
Table 206 – FLOGI/PLOGI CS_QoS_Request .....	197
Table 207 – Fx_Port Clock Synchronization QoS .....	199
Table 208 – Virtual Fabrics Bit Usage .....	205
Table 209 – VE Identification Server Mappings .....	213



# American National Standard for Information Technology —

## Fibre Channel — Link Services - 4 (FC-LS-4)

### 1 Scope

FC-LS describes in detail the Fibre Channel Extended Link Services.

### 2 Normative References

#### 2.1 Overview

The following standards contain provisions that, through reference in the text, constitute provisions of this standard. At the time of publication, the editions indicated were valid. All standards are subject to revision, and parties to agreements based on this standard are encouraged to investigate the possibility of applying the most recent editions of the standards listed below.

Copies of the following documents may be obtained from ANSI, an ISO member organization:

Approved ANSI standards; approved international and regional standards (ISO and IEC); and approved foreign standards (including JIS and DIN).

For further information, contact the ANSI Customer Service Department:

Phone +1 212-642-4900  
Fax: +1 212-302-1286  
Web: <http://www.ansi.org>  
E-mail: [ansionline@ansi.org](mailto:ansionline@ansi.org)

or the InterNational Committee for Information Technology Standards (INCITS):

Phone 202-737-8888  
Web: <http://www.incits.org>  
E-mail: [incits@itic.org](mailto:incits@itic.org)

Additional availability contact information is provided below as needed.

#### 2.2 Approved references

INCITS 332:1999, *Fibre Channel-Arbitrated Loop-2 (FC-AL-2)*

INCITS 332:1999/AM1-2003, *Fibre Channel-Arbitrated Loop-2 (FC-AL-2) Amendment 1*

INCITS 488:2016, *Fibre Channel - Framing and Signaling - 4 (FC-FS-4)*

INCITS 510:2016, *Fibre Channel - Generic Services - 7 (FC-GS-7)*

INCITS 511:2016, *Fibre Channel - Switch Fabric - 6 (FC-SW-6)*

INCITS 485:2014, *Fibre Channel - Single Byte Command Set - 5 (FC-SB-5)*

INCITS 481:2011, *Fibre Channel - Protocol - 4 (FCP-4)*

INCITS 509:2014, *Fibre Channel - Backbone - 6 (FC-BB-6)*

INCITS TR-47:2012, *Fibre Channel - Simplified Configurations and Management (FC-SCM)*

### **2.3 References under development**

At the time of publication, the following referenced standards were still under development. For information on the current status of the documents, or regarding availability, contact the relevant standards body or other organization as indicated.

INCITS 545, *Fibre Channel - Framing and Signaling - 4 (FC-FS-5)*

INCITS 548, *Fibre Channel Generic Services - 8 (FC-GS-8)*

INCITS 547, *Fibre Channel - Switch Fabric - 7 (FC-SW-7)*

INCITS 544, *Fibre Channel - Single Byte Command Set - 6 (FC-SB-6)*

### **2.4 Other references**

For more information on the current status of SFF documents, contact the SFF Committee at 408-867- 6630 (phone), or 408-867-2115 (fax). To obtain copies of these documents, contact the SFF Committee at 14426 Black Walnut Court, Saratoga, CA 95070 at 408-867-6630 (phone) or 408-741-1600 (fax) or see <http://www.sffcommittee.org>.

SFF document SFF-8472 - Diagnostic Monitoring Interface for Optical Transceivers (Rev 11.3 June 11, 2013)

SFF document SFF-8636 - Specification for Common Management Interface (Rev 2.3 October 15, 2014)

IETF Request for Comments (RFCs) may be obtained directly from the IETF web site at <http://www.ietf.org/rfc.html>:

RFC 768, *User Datagram Protocol*, August 1980.

RFC 791, *Internet Protocol*, September 1981.

RFC 793, *Transmission Control Protocol*, September 1981.

RFC 854, *Telnet Protocol Specification*, May 1983.

RFC 1157, *A Simple Network Management Protocol (SNMP)*, May 1990.

RFC 1901, *Introduction to Community-based SNMPv2*, January 1996

RFC 2460, *Internet Protocol, Version 6 (IPv6) Specification*, December 1998.

RFC 2616, *Hypertext Transfer Protocol -- HTTP/1.1*, June 1999.

RFC 2818, *HTTP Over TLS*, May 2000.

RFC 4291, *IP Version 6 Addressing Architecture*, February 2006.

RFC 5095, *Deprecation of Type 0 Routing Headers in IPv6*, December 2007.

RFC 4338, *Transmission of IPv6, IPv4, and Address Resolution Protocol (ARP) Packets over Fibre Channel*, January 2006.

### 3 Definitions and conventions

#### 3.1 Overview

For FC-LS-4, the following definitions, conventions, abbreviations, acronyms, and symbols apply.

#### 3.2 Definitions

##### 3.2.1 acknowledged class

class of service that acknowledges a transfer

##### 3.2.2 address identifier

address value used to identify source (i.e., S\_ID) or destination (i.e., D\_ID) of a frame

Note 1 to entry: See FC-FS-4.

##### 3.2.3 AE Principal Switch

AE Switch that has no Uplinks and assumes the primary role of distributing the Domain Topology Map in an Avionics Fabric

Note 1 to entry: See FC-SW-6.

##### 3.2.4 AE Switch

AE-Capable Switch that has activated at least one AE\_Port

Note 1 to entry: AE Switches are required to implement the requirements defined for Fast Fabric Initialization in FC-SW-6.

##### 3.2.5 Arbitrated Loop topology

Fibre Channel topology where L\_Ports use arbitration to gain access to the loop

Note 1 to entry: See FC-AL-2.

##### 3.2.6 Avionics Fabric

Fibre Channel Fabric that contains at least one AE Switch and supports all the requirements defined for Fast Fabric Initialization in FC-SW-6

##### 3.2.7 buffer-to-buffer credit

###### BB\_Credit

limiting value for BB\_Credit\_CNT in the buffer-to-buffer flow control model

Note 1 to entry: See FC-FS-4.

##### 3.2.8 buffer-to-buffer Credit\_Count

###### BB\_Credit\_CNT

counter used in the buffer-to-buffer flow control model

Note 1 to entry: See FC-FS-4.

##### 3.2.9 B\_Port

Fabric inter-element port used to connect bridge devices with E\_Ports on a switch by providing a subset of E\_Port functionality

Note 1 to entry: See FC-SW-6.

**3.2.10 buffer**

logical construct that holds a single frame

**3.2.11 class of service**

type of frame delivery service used by the communicating Nx\_Ports

Note 1 to entry: See FC-FS-4.

**3.2.12 Class 2 service**

service that multiplexes frames at frame boundaries to or from one or more Nx\_Ports with acknowledgement provided

Note 1 to entry: See FC-FS-4.

**3.2.13 Class 3 service**

service that multiplexes frames at frame boundaries to or from one or more Nx\_Ports without acknowledgement

Note 1 to entry: See FC-FS-4.

**3.2.14 Class F service**

service that multiplexes frames at frame boundaries with acknowledgement provided to control and coordinate the internal behavior of the Fabric

Note 1 to entry: See FC-SW-6.

**3.2.15 continuously increasing relative offset**

condition of operation that requires frames ordered by SEQ\_CNT within a Sequence to have a larger relative offset value in each frame

Note 1 to entry: See FC-FS-4.

**3.2.16 Core N\_Port\_Name**

N\_Port\_Name used in EVFP (see 4.3.38) that is associated with a VFT Tagging PN\_Port, and not with any other PN\_Port or FC\_Port within the scope of its Name\_Identifier format

**3.2.17 Core Switch\_Name**

Switch\_Name identifying the physical Switch (see FC-SW-6) in a Virtual Fabric capable Switch

**3.2.18 Credit**

number of buffers available at a recipient to receive frames from a transmitting FC\_Port

Note 1 to entry: See FC-FS-4.

**3.2.19 data block**

ordered string of application data contained in a single Information Category

**3.2.20 data frame**

FC-4 Device\_Data frame, an FC-4 Video\_Data frame, or a Link\_Data frame

Note 1 to entry: See FC-FS-4.

**3.2.21 Destination\_Identifier****D\_ID**

address identifier used to indicate the targeted destination FC\_Port of the transmitted frame

Note 1 to entry: See FC-FS-4.

**3.2.22 destination Nx\_Port**

Nx\_Port designated by the Destination\_Identifier of a frame

**3.2.23 discard policy**

error handling policy where a Sequence Recipient is able to discard Data frames received following detection of a missing frame in a Sequence

Note 1 to entry: See FC-FS-4.

**3.2.24 Domain Controller**

entity that controls activity within a given domain that is allocated an address

Note 1 to entry: See FC-SW-6.

**3.2.25 Domain\_ID**

highest or most significant hierarchical level in the three-level addressing hierarchy (i.e., the most significant byte of the address identifier)

Note 1 to entry: See FC-FS-4 and FC-SW-6.

**3.2.26 Domain Topology Map**

entity within the Avionics Fabric (see FC-SW-6) that unambiguously describes the Domain\_IDs and all of the Inter-Switch Links of the Avionics Fabric

**3.2.27 end-to-end Credit****EE\_Credit**

limiting value for EE\_Credit\_CNT in the end-to-end flow control model

Note 1 to entry: See FC-FS-4.

**3.2.28 end-to-end Credit\_Count****EE\_Credit\_CNT**

counter used in the end-to-end flow control model

Note 1 to entry: See FC-FS-4.

**3.2.29 E\_Port**

Fabric expansion port that connects to another E\_Port or B\_Port to create an Inter-Switch Link

Note 1 to entry: See FC-SW-6.

**3.2.30 Exchange**

unit of protocol activity, identified by an OX\_ID and RX\_ID (see FC-FS-3), that transfers information between a specific Originator FC\_Port and specific Responder FC\_Port using one or more related non-concurrent Sequences that may flow in the same or opposite directions

**3.2.31 Exchange\_Identifier****X\_ID**

collective reference to OX\_ID and RX\_ID

Note 1 to entry: See FC-FS-3.

**3.2.32 Exchange Status Block**

logical construct that contains the status of an Exchange

Note 1 to entry: See FC-FS-3.

**3.2.33 F\_Port**

FC\_Port within the Fabric that attaches to a PN\_Port through a link, and is addressable by the Nx\_Ports communicating through the PN\_Port attached to the F\_Port by the F\_Port Controller well-known address (i.e., FFFFFFFEh)

Note 1 to entry: See FC-SW-5.

**3.2.34 Fabric**

entity that interconnects Nx\_Ports attached to it and is capable of routing frames by using the D\_ID information in a Frame\_Header

Note 1 to entry: See FC-FS-3.

**3.2.35 Fabric Controller**

logical entity responsible for operation of the Fabric identified by the well-known address FFFFFFFDh

Note 1 to entry: See FC-SW-5.

**3.2.36 F\_Port Controller**

entity at the well-known address FFFFFFFEh

Note 1 to entry: See FC-SW-5.

**3.2.37 Fabric\_Name**

Name\_Identifier associated with a Fabric

Note 1 to entry: See FC-FS-3.

**3.2.38 Fabric VE ID**

{N\_Port\_ID, Local VE ID} pair of values used to identify a VE within a Fabric

**3.2.39 Fast Fabric Initialization****FFI**

technique that provides accelerated initialization of an Avionics Fabric through the distribution of the Domain Topology Map using the FFI request Sequence

Note 1 to entry: See FC-SW-5.

**3.2.40 FC-4 TYPE**

value in the Type field in the header of a data frame associated with an FC-4 protocol

Note 1 to entry: See FC-FS-3.

**3.2.41 FC\_Port**

port that is capable of transmitting and receiving Fibre Channel frames according to the FC-0, FC-1, and FC-2 levels of the Fibre Channel architecture

Note 1 to entry: See FC-FS-3.

**3.2.42 FFI Link State Record**

for an individual AE Switch, a description of the Domain and all the AE\_Port Inter-Switch Link connections of that Switch

Note 1 to entry: See FC-SW-5.

**3.2.43 FFI SW\_ILS**

AE specific SW\_ILS command that distributes the Domain Topology Map throughout the Avionics Fabric or for reporting changes in link status and error conditions

Note 1 to entry: See FC-SW-5.

**3.2.44 Fibre Channel interaction space**

set of Fibre Channel ports, devices, and Fabrics that are connected by Fibre Channel links or are accessible by a common instance of an administrative tool or tools

**3.2.45 FL\_Port**

F\_Port that contains Arbitrated Loop functions associated with Arbitrated Loop topology

Note 1 to entry: See FC-AL-2.

**3.2.46 frame**

indivisible unit of information used by FC-2

Note 1 to entry: See FC-FS-3.

**3.2.47 F\_Port\_Name**

Name\_Identifier associated with an F\_Port

Note 1 to entry: See FC-FS-3.

**3.2.48 Fx\_Port**

switch port capable of operating as an F\_Port or FL\_Port

Note 1 to entry: See FC-FS-3 and FC-AL-2.

**3.2.49 Global VE ID**

identifier used to uniquely identify a Virtual Entity

Note 1 to entry: For example a 16-byte Universally Unique Identifier (UUID, see RFC 4122).

**3.2.50 Hypertext Transfer Protocol**

protocol for communicating various formats of text with embedded links and display controls

Note 1 to entry: See RFC 2616.



**3.2.51 Infinite buffer**

terminology to indicate that at FC-2 level, the amount of buffer available at the Sequence Recipient is unlimited

**3.2.52 Information Category**

category to which the frame Payload belongs (e.g., Solicited Data, Unsolicited Data, Solicited Control and Unsolicited Control)

Note 1 to entry: See FC-FS-3.

**3.2.53 Information Unit**

organized collection of data specified by an upper level to be transferred as a single Sequence by FC-2

**3.2.54 initial relative offset**

relative offset value specified at the sending end by an upper level for a given data block and used by the sending FC-2 in the first frame of that data block

Note 1 to entry: Initial relative offset value may be zero or non-zero (see FC-FS-3).

**3.2.55 Internet Protocol**

protocol for communicating data packets between identified endpoints on a multipoint network

Note 1 to entry: See RFC 791, RFC 2460, RFC 4291, and RFC 5095.

**3.2.56 IP Address**

identifier of an endpoint in Internet Protocol

**3.2.57 link**

one or more pairs of unidirectional fibres transmitting in opposite directions and their associated transmitters and receivers

**3.2.58 Link Control Facility****LCF**

hardware facility that attaches to an end of a link and manages transmission and reception of data

Note 1 to entry: See FC-FS-3.

**3.2.59 local Fx\_Port**

Fx\_Port to which an Nx\_Port is directly attached by a link or an Arbitrated Loop

**3.2.60 Local VE ID**

value used to locally identify a VE within a VEM

Note 1 to entry: The local VE ID has a scope local to an N\_Port\_ID and is carried in the Priority field of the FC header.

**3.2.61 Loop Fabric Address****LFA**

address identifier used to address an FL\_Port for the purpose of loop management

Note 1 to entry: See FC-SW-5.

**3.2.62 Loss-of-signal**

indication by an FC\_Port that it is unable to detect an input signal on its physical interface

Note 1 to entry: See FC-FS-3.

**3.2.63 L\_Port**

FC\_Port that contains Arbitrated Loop functions associated with Arbitrated Loop topology

Note 1 to entry: See FC-AL-2.

**3.2.64 Multi-function device**

device that provides more than one function

**3.2.65 Multiplexer**

entity that provides the functions of the FC-2M sublevel

Note 1 to entry: See FC-FS-3.

**3.2.66 Name\_Identifier**

64-bit identifier used to identify entities in Fibre Channel (e.g., Nx\_Port, node, F\_Port, or Fabric)

Note 1 to entry: See FC-FS-3.

**3.2.67 NAS server**

device that connects to a network and provides file access services

**3.2.68 Network\_Address\_Authority****NAA**

organization such as IEEE that administers network addresses

**3.2.69 Network\_Address\_Authority identifier**

four-bit identifier defined to indicate a Network\_Address\_Authority

Note 1 to entry: See FC-FS-3.

**3.2.70 NL\_Port**

Nx\_Port communicating through a PN\_Port that is operating a Loop Port State Machine

Note 1 to entry: See FC-AL-2.

**3.2.71 node**

collection of one or more Nx\_Ports controlled by a level above FC-2

Note 1 to entry: See FC-FS-3.

**3.2.72 Node\_Name**

Name\_Identifier associated with a node

Note 1 to entry: See FC-FS-3.

**3.2.73 N\_Port**

Nx\_Port communicating through a PN\_Port

Note 1 to entry: See FC-FS-3.

**3.2.74 N\_Port\_ID**

address identifier of an Nx\_Port used in the S\_ID and D\_ID fields of a frame

Note 1 to entry: See FC-FS-3.

**3.2.75 N\_Port\_ID Virtualization**

**NPIV**

ability of the multiplexer of a PF\_Port or a PN\_Port to support more than one VN\_Port

**3.2.76 N\_Port\_Name**

Name\_Identifier associated with an Nx\_Port

**3.2.77 Nx\_Port**

end point for Fibre Channel frame communication that is used in this standard to specify behavior of either N\_Ports or Public NL\_Ports (see FC-AL-2)

Note 1 to entry: See FC-FS-3.

**3.2.78 open Exchange**

period of time starting when an Exchange is initiated until that Exchange is normally or abnormally terminated (see FC-FS-3)

**3.2.79 open Sequence**

period of time starting when a Sequence is initiated until that Sequence is normally or abnormally terminated (see FC-FS-3)

**3.2.80 Originator**

logical function associated with an Nx\_Port that originates an Exchange

**3.2.81 Originator Exchange\_ID**

**OX\_ID**

identifier assigned by an Originator to identify an Exchange (see FC-FS-3)

**3.2.82 Payload**

contents of the Data\_Field of a frame, excluding Optional Headers and fill bytes, if present

Note 1 to entry: See FC-FS-3.

**3.2.83 Permanent Port Name**

Name\_Identifier associated with a PN\_Port

Note 1 to entry: See FC-GS-6.

**3.2.84 PF\_Port**

LCF within a Fabric that attaches to a PN\_Port through a link

Note 1 to entry: See FC-SW-5.

**3.2.85 Platform**

container for one or more nodes and one or more LCFs

Note 1 to entry: Any additional characteristics of a platform are outside the scope of this standard (e.g., see FC-GS-6).

**3.2.86 PN\_Port**

LCF that supports only Nx\_Ports (see FC-FS-3)

**3.2.87 Policy**

rule or rules used to determine how frames not received are handled during error recovery

Note 1 to entry: See FC-FS-3.

**3.2.88 Port VF\_ID**

configurable VF\_ID that is associated with any untagged frame received by a VF capable PN\_Port or F\_Port

Note 1 to entry: See FC-FS-3.

**3.2.89 Private NL\_Port**

NL\_Port that does not attempt a Fabric Login and does not transmit OPN(00,x)

Note 1 to entry: See FC-AL-2.

**3.2.90 Public NL\_Port**

NL\_Port that attempts a Fabric Login

Note 1 to entry: See FC-AL-2.

**3.2.91 random relative offset**

relationship specified between relative offset values contained in frame (n) and frame (n+1) of an Information Category within a single Sequence (see FC-FS-3), in which the relative offset of frame (n+1) is not related to the relative offset of frame (n)

**3.2.92 relative offset**

displacement, expressed in bytes, of the first byte of a Payload related to an upper level defined origin for a given Information Category (see FC-FS-3)

**3.2.93 relative offset space**

address space defined by the sending upper level for a set of information carried in one or more information units

**3.2.94 Responder**

logical function in an Nx\_Port responsible for supporting the Exchange initiated by the Originator in another Nx\_Port

**3.2.95 Responder Exchange\_ID****RX\_ID**

identifier assigned by a Responder to identify an Exchange

**3.2.96 Secured Hypertext Transfer Protocol**

protocol for communicating various formats of text with embedded links and display controls used in combination with a subordinate protocol that provides security features (see RFC 2818)

**3.2.97 Sequence**

set of one or more Data frames within an Exchange with a common Sequence\_ID (SEQ\_ID), transmitted unidirectionally from one Nx\_Port to another Nx\_Port

Note 1 to entry: See FC-FS-3.

**3.2.98 Sequence\_ID****SEQ\_ID**

identifier used to identify a Sequence (see FC-FS-3)

**3.2.99 Sequence Initiator**

FC\_Port that initiates a Sequence and transmits Data frames to the destination FC\_Port

Note 1 to entry: See FC-FS-3.

**3.2.100 Sequence Recipient**

FC\_Port that receives Data frames from the Sequence Initiator

Note 1 to entry: See FC-FS-3.

**3.2.101 Sequence Status Block**

logical construct that tracks the status of a Sequence

Note 1 to entry: See FC-FS-3.

**3.2.102 Simple Network Management Protocol****SNMP**

protocol for communicating simply structured management information (see IETF STD 62)

**3.2.103 Source\_Identifier****S\_ID**

address identifier used to indicate the source Nx\_Port of the transmitted frame

Note 1 to entry: See FC-FS-3.

**3.2.104 source Nx\_Port**

Nx\_Port where a frame originated

**3.2.105 Storage access device**

device that provides storage management and access for heterogeneous hosts and heterogeneous devices (e.g., a medium changer device)

**3.2.106 Storage subsystem**

integrated collection of storage controllers, storage devices, and necessary software, that provides storage services to one or more hosts

**3.2.107 streamed Sequence**

new sequence initiated by a Sequence Initiator in any class of service for an Exchange while it already has Sequences open for that Exchange (see FC-FS-3)

**3.2.108 T10 Vendor ID**

character string that uniquely identifies a vendor

Note 1 to entry: See 3.8.

**3.2.109 TCP Port Number**

identifier of a destination in Transmission Control Protocol

**3.2.110 Telnet**

protocol for communicating control of a character-oriented terminal over Transmission Control Protocol (see RFC 854)

**3.2.111 Transmission Control Protocol****TCP**

protocol communicating reliable flow-controlled byte streams over Internet Protocol allowing independent concurrent streams to multiple destinations at any IP Address (see RFC 793)

**3.2.112 UDP Port Number**

identifier of a destination in User Datagram Protocol (see RFC 768)

**3.2.113 Upper Level**

level above FC-2

**3.2.114 Upper Level Protocol****ULP**

protocol user of FC-4 (see FC-FS-3)

**3.2.115 User Datagram Protocol****UDP**

protocol communicating a packet stream with no incremental reliability over Internet Protocol allowing multiple independent concurrent destinations at any IP Address

Note 1 to entry: See RFC 768.

**3.2.116 Virtual E\_Port****VE\_Port**

instance of the FC-2V sublevel of Fibre Channel that communicates with another VE\_Port

Note 1 to entry: See FC-BB-6.

**3.2.117 VEM ID**

identifier used to uniquely identify a VEM

Note 1 to entry: For example a 16-byte Universally Unique Identifier (UUID, see RFC 4122).

**3.2.118 VFT Tagging PF\_Port**

PF\_Port operating with a Multiplexer that has enabled processing of Virtual Fabric Tagging Headers (see FC-FS-3)

**3.2.119 VFT Tagging PN\_Port**

PN\_Port operating with a Multiplexer that has enabled processing of Virtual Fabric Tagging Headers (see FC-FS-3)

**3.2.120 Virtual Entity****VE**

virtualized resource

Note 1 to entry: For example a Virtual Machine (VM).

**3.2.121 Virtual Entities Manager****VEM**

entity managing Virtual Entities

Note 1 to entry: For example a Hypervisor.

**3.2.122 Virtualization device**

device that integrates one or more entities (either logical or physical), along with any additional functionality, for the purpose of providing a useful abstraction (e.g., a SCSI logical unit virtualization device)

**3.2.123 VN\_Port**

instance of the FC-2V sublevel, synonymous with Nx\_Port, that is used when it is desired to emphasize support for multiple Nx\_Ports in a single Multiplexer (e.g., via a single PN\_Port)

**3.2.124 Wavelength division multiplexer**

device that modulates/demodulates each of several data streams (e.g., Fibre Channel protocol data streams) to/from a different part of the light spectrum in an optical fiber

**3.2.125 Well-known address**

**WKA**

address identifier explicitly defined in this standard or other standards to access services (e.g., name server)

**3.2.126 Worldwide\_Name**

**WWN**

Name\_Identifier that is worldwide unique

Note 1 to entry: See FC-FS-3.

**3.3 Editorial Conventions**

In this standard, a number of conditions, mechanisms, sequences, parameters, events, states or other terms are printed with the first letter of each word in uppercase and the rest lowercase. This indicates that they have a special meaning in the context of this standard. The meaning is either described in the relevant text, in the glossary of this standard, or in a referenced standard (e.g., Exchange and Class). Any use of these terms in lowercase indicates that the words have the normal technical English meanings.

Lists sequenced by letters (e.g., a-red, b-blue, c-green) show no priority relationship between the listed items. Numbered lists (e.g., 1-red, 2-blue, 3-green) show a priority ordering between the listed items.

The ISO/British convention of decimal number representation is used in this standard. Numbers may be separated by single spaces into groups of three digits counting from the decimal position, and a period is used as the decimal marker. A comparison of the ISO/British, ISO/French, and American conventions is shown in table 1.

**Table 1 – Comparison of numbering conventions**

ISO/British	ISO/French	American
0.6	0,6	0.6
3.14159265	3,141 592 65	3.14159265
1 000	1 000	1,000
1 323 462.9	1 323 462,9	1,323,462.9

In case of any conflict between figure, table, and text, the text, then tables, and finally figures take precedence. Exceptions to this convention are indicated in the appropriate sections.

In all of the figures, tables, and text of this document, the most significant bit of a binary quantity is shown on the left side. Exceptions to this convention are indicated in the appropriate sections.

When the value of the bit or field is not relevant, x or xx appears in place of a specific value.

Unless stated otherwise: numbers that are not immediately followed by lower-case b or h are decimal values; numbers immediately followed by lower-case b (xxb) are binary values; and numbers or upper case letters immediately followed by lower-case h (xxh) are hexadecimal values.

### 3.4 State Machine notation

State machines in this standard use the style shown in figure 1.

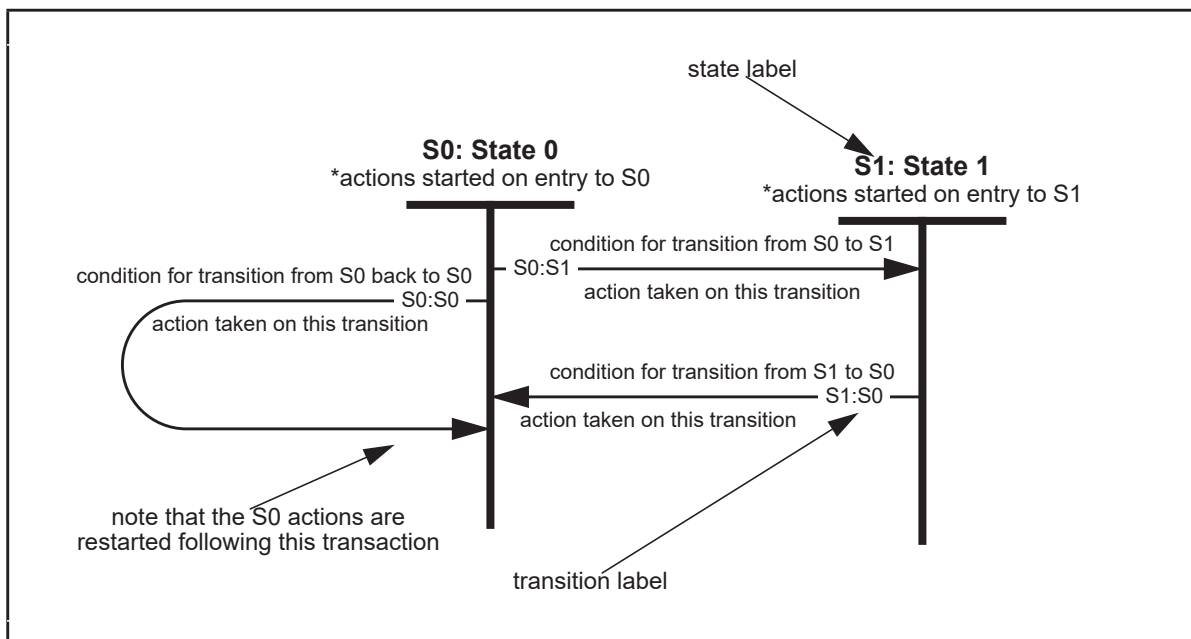

**Figure 1 – State Machine Example**

These state machines make three assumptions:

- a) Time elapses only within discrete states.
- b) State transitions are logically instantaneous, so the only actions taken during a transition are setting flags and variables and sending signals. These actions complete before the next state is entered.
- c) Every time a state is entered, the actions of that state are started. Note that this means that a transition that points back to the same state repeats the actions from the beginning. All the actions started upon entry complete before any tests are made to exit the state.



### 3.5 Abbreviations and acronyms

Abbreviations and acronyms applicable to this standard are listed. Definitions of several of these items are included in 3.2.

<b>ABTS</b>	Abort Sequence
<b>ACK</b>	Acknowledgement
<b>ADVC</b>	Advise Credit
<b>AE</b>	Avionics Environment
<b>AL_PA</b>	Arbitrated Loop Physical Address
<b>BA_ACC</b>	Basic Accept
<b>BB_Credit</b>	buffer-to-buffer Credit
<b>BB_Credit_CNT</b>	buffer-to-buffer Credit_Count
<b>BB_SCs</b>	buffer-to-buffer State Change (SOF)
<b>BB_SCr</b>	buffer-to-buffer State Change (R_RDY)
<b>BB_SC_N</b>	buffer-to-buffer State Change Number
<b>BSY</b>	busy
<b>Credit_CNT</b>	Credit_Count
<b>DF_CTL</b>	Data_Field Control
<b>D_ID</b>	Destination_Identifier
<b>DSCP</b>	Differentiated Services Code Point
<b>E_D_TOV</b>	Error_Detect_Timeout value
<b>EE_Credit</b>	end-to-end Credit
<b>EE_Credit_CNT</b>	end-to-end Credit_Count
<b>ELS</b>	Extended Link Service
<b>ELS_Command</b>	Extended Link Service Command
<b>ESB</b>	Exchange Status Block
<b>ESTC</b>	Estimate Credit
<b>ESTS</b>	Establish Streaming
<b>F_BSY</b>	Fabric_Port_Busy
<b>F_BSY(DF)</b>	F_BSY response to a Data frame
<b>F_BSY(LC)</b>	F_BSY response to any Link_Control except P_BSY
<b>FC</b>	Fibre Channel
<b>FC-2</b>	FC-2 level (see FC-FS-3)
<b>FC-4</b>	FC-4 level (see FC-FS-3)
<b>F_CTL</b>	Frame Control (see FC-FS-3)
<b>FFI</b>	Fast Fabric Initialization
<b>FLOGI</b>	Fabric Login
<b>F_RJT</b>	Fabric Reject
<b>HBA</b>	Host Bus Adapter
<b>hex</b>	hexadecimal notation
<b>HTTP</b>	Hypertext Transfer Protocol
<b>HTTPS</b>	Secured Hypertext Transfer Protocol
<b>IEEE</b>	Institute of Electrical and Electronics Engineers
<b>IP</b>	Internet Protocol
<b>LCF</b>	Link Control Facility
<b>LCR</b>	Link Credit Reset
<b>LESB</b>	Link Error Status Block (see FC-FS-3)
<b>LFA</b>	Loop Fabric Address (see FC-AL-2)
<b>LILP</b>	Loop Initialization Loop Position (see FC-AL-2)
<b>LIP</b>	Loop Initialization Primitive (see FC-AL-2)
<b>LISA</b>	Loop Initialization Soft Assigned (see FC-AL-2)
<b>LOGO</b>	Logout
<b>LR</b>	Link Reset Primitive Sequence (see FC-FS-3)

<b>LRR</b>	Link Reset Response Primitive Sequence (see FC-FS-3)
<b>LS_ACC</b>	Link Service Accept
<b>m</b>	Metre
<b>MB</b>	MegaByte
<b>ms</b>	millisecond
<b>µs</b>	microsecond
<b>N/A</b>	not applicable
<b>NAA</b>	Network_Address_Authority
<b>NAS</b>	Network Attached Storage
<b>NOP</b>	No Operation
<b>NOS</b>	Not_Operational Primitive Sequence (see FC-FS-3)
<b>NPIV</b>	N_Port_ID Virtualization
<b>ns</b>	nanosecond
<b>OLS</b>	Offline Primitive Sequence (see FC-FS-3)
<b>OX_ID</b>	Originator Exchange_ID
<b>P_BSY</b>	N_Port_Busy
<b>PDISC</b>	Discover N_Port Service Parameters
<b>PLOGI</b>	N_Port Login
<b>P_RJT</b>	N_Port_Reject
<b>PRLI</b>	Process Login
<b>PRLO</b>	Process Logout
<b>R_A_TOV</b>	Resource_Allocation_Timeout value (see FC-FS-3)
<b>R_CTL</b>	Routing Control
<b>RJT</b>	reject
<b>RO</b>	relative offset
<b>R_RDY</b>	Receiver_Ready
<b>R_T_TOV</b>	Receiver_Transmitter_Timeout value
<b>RTV</b>	Read Timeout Value
<b>RX_ID</b>	Responder Exchange_ID
<b>s</b>	second
<b>SBCCS</b>	Single Byte Command Code Sets
<b>SCR</b>	State Change Registration
<b>SEQ_CNT</b>	Sequence Count
<b>SEQ_ID</b>	Sequence_ID
<b>S_ID</b>	Source_Identifier
<b>SNMP</b>	Simple Network Management Protocol
<b>SOF</b>	Start-of-Frame (see FC-FS-3)
<b>SSB</b>	Sequence Status Block
<b>TCP</b>	Transmission Control Protocol
<b>TPLS</b>	Test Process Login Status
<b>TYPE</b>	Data structure type
<b>UDP</b>	User Datagram Protocol
<b>ULP</b>	Upper Level Protocol
<b>WWN</b>	Worldwide_Name
<b>X_ID</b>	Exchange_Identifier

### 3.6 Symbols

Unless indicated otherwise, the following symbols have the listed meaning.

	concatenation
m	micro (e.g., µm = micrometer)

## 3.7 Keywords

**3.7.1 expected:** A keyword used to describe the behavior of the hardware or software in the design models assumed by this standard. Other hardware and software design models may also be implemented.

**3.7.2 ignored:** A keyword used to describe an unused bit, byte, word, field or code value. The contents or value of an ignored bit, byte, word, field or code value shall not be examined by the receiving device and may be set to any value by the transmitting device.

**3.7.3 invalid:** A keyword used to describe an illegal or unsupported bit, byte, word, field or code value. Receipt of an invalid bit, byte, word, field or code value shall be reported as an error.

**3.7.4 mandatory:** A keyword indicating an item that is required to be implemented as defined in this standard.

**3.7.5 may:** A keyword that indicates flexibility of choice with no implied preference (equivalent to “may or may not”).

**3.7.6 may not:** A keyword that indicates flexibility of choice with no implied preference (equivalent to “may or may not”).

**3.7.7 meaningful:** A control field or bit that shall be applicable and that shall be interpreted by the recipient.

**3.7.8 not meaningful:** A control field or bit that shall be ignored by the recipient.

**3.7.9 obsolete:** A keyword indicating that an item was defined in prior Fibre Channel standards but has been removed from this standard.

**3.7.10 optional:** A keyword that describes features that are not required to be implemented by this standard. However, if any optional feature defined by this standards is implemented, then it shall be implemented as defined in this standard.

**3.7.11 reserved:** A keyword referring to bits, bytes, words, fields and code values that are set aside for future standardization. A reserved bit, byte, word or field shall be set to zero, or in accordance with a future extension to this standard. Recipients are not required to check reserved bits, bytes, words or fields for zero values. Receipt of reserved code values in defined fields shall be reported as error.

**3.7.12 restricted:** A keyword referring to bits, bytes, words, and fields that are set aside for use in other Fibre Channel standards. A restricted bit, byte, word, or field shall be treated as a reserved bit, byte, word or field for the purposes of the requirements defined in this standard.

**3.7.13 shall:** A keyword indicating a mandatory requirement. Designers are required to implement all such mandatory requirements to ensure interoperability with other products that conform to this standard.

**3.7.14 should:** A keyword indicating flexibility of choice with a strongly preferred alternative; equivalent to the phrase “it is strongly recommended”.

**3.7.15 x or xx:** The value of the bit or field is not relevant.

### **3.8 T10 Vendor ID fields**

A T10 Vendor ID shall be a string of one to eight characters that is recorded in an informal list of Vendor IDs maintained by INCITS Technical Committee T10 (see <http://www.t10.org>).

A field described as containing a T10 Vendor ID shall contain the first character of the T10 Vendor ID in the most significant byte of the field, and successive characters of the T10 Vendor ID in successively less significant bytes of the field. Any bytes of the field not filled by characters of the T10 Vendor ID shall be filled with ASCII space characters (20h).

## 4 Extended Link Services

### 4.1 Introduction

An Extended Link Service (ELS) request solicits a destination Nx\_Port to perform a function. An ELS reply shall be transmitted in response to an ELS request, unless otherwise specified. Each request or reply is composed of a single Sequence with the ELS\_Command code being specified in the first word of the Payload of the first frame of the Sequence. If Zoning is active in the Fabric (see FC-GS-6), an ELS response from a well-known address (e.g., the Domain Controller) shall only include data relating to Nx\_Ports that are in the same zone(s) as the requesting Nx\_Port.

Each Sequence may be composed of one or more frames. Normal rules for Exchange and Sequence management apply to ELS frames, Sequences, and Exchanges. An Accept (LS\_ACC) to an ELS shall terminate the Exchange by setting the Last Sequence bit to one on the last frame of the reply. An ELS request and the corresponding reply shall be performed within a single Exchange. Normal rules for Exchange and Sequence management as defined in FC-FS-3 shall apply.

The TYPE field for ELS frames shall be set to 01h.

The R\_CTL field for ELS frames shall be set as specified in table 2.

**Table 2 – Extended Link Services Routing Bits and Information Categories**

R_CTL		Description
ROUTING	INFORMATION	
0010b	0001b	Solicited Data <sup>a</sup>
	0010b	Request
	0011b	Reply
	Others	Reserved
<sup>a</sup> This value is only used by the Clock Synchronization Update (CSU) ELS.		

The first byte of the Payload (ELS\_Command code) of the request or reply Sequence shall be as shown in table 9. The remainder of the Payload is ELS unique. Subsequent frames, if any, for a request or reply Sequence shall only contain additional Payload in the Payload field (i.e., the ELS\_Command code is not repeated in each frame).

## 4.2 Link Service tag, length, value (TLV) descriptors

### 4.2.1 Overview

Some Link Service payloads are structured using tag, length, value (TLV) format descriptors. If a Link Service payload contains TLV format descriptors, then the TLV descriptor format shall be as specified in table 3.

**Table 3 – Link Service TLV descriptor format**

Bits Word	31 .. 24	23 .. 16	15 .. 08	07 .. 00
0	Descriptor tag			
1	Descriptor length			
2 - n	Descriptor value			

**Descriptor tag:** contains the tag value of the Link Service TLV descriptor.

**Descriptor length:** contains the length in bytes of the descriptor value field. A descriptor length value of zero is valid (i.e., the tag has no descriptor value). The descriptor length value indicates the number of valid data bytes in the payload (i.e., any pad bytes are not included).

**Descriptor value:** contains the Link Service specific information for the descriptor tag. The descriptor value field shall be padded with zeros to an integral number of words.

The first word in a TLV format Link Service request payload or response payload shall contain an ELS command code (see table 9) followed by three zero bytes (i.e., XXh 00h 00h 00h).

The second word in a TLV format Link Service request payload or a LS\_ACC response payload shall contain a length field that represents the entire length of the list of Link Service TLV descriptors that follow (see table 6), including pad bytes, if any.

### 4.2.2 Link Service request with Link Service TLV descriptor payload example

A Link Service request with a Link Service TLV descriptor payload example is specified in table 4.

**Table 4 – Link Service request with Link Service TLV descriptor payload example**

Bits Word	31 .. 24	23 .. 16	15 .. 08	07 .. 00
0	Command code	00h	00h	00h
1	Descriptor list length = 28			
2	Descriptor tag = XXXX XXXXh			
3	Descriptor length = 4			
4	Descriptor value			
5	Descriptor tag = XXXX XXXXh			
6	Descriptor length = 8			
7	Descriptor value [first word]			
8	Descriptor value [last word]			

**4.2.3 Link Service accept with Link Service TLV descriptor payload example**

A Link Service accept with a TLV format link service descriptor payload example is specified in table 5.

**Table 5 – Link Service accept with Link Service TLV descriptor payload example**

<b>Bits Word</b>	<b>31 .. 24</b>	<b>23 .. 16</b>	<b>15 .. 08</b>	<b>07 .. 00</b>
<b>0</b>	02h	00h	00h	00h
<b>1</b>	Descriptor list length = 40			
<b>2</b>	Descriptor tag = 0000 0001h			
<b>3</b>	Descriptor length = 4			
<b>4</b>	Descriptor value = request payload word 0 value			
<b>5</b>	Descriptor tag = XXXX XXXXh			
<b>6</b>	Descriptor length = 3			
<b>7</b>	Descriptor value			Pad byte
<b>8</b>	Descriptor tag = XXXX XXXXh			
<b>9</b>	Descriptor length = 8			
<b>10</b>	Descriptor value [first word]			
<b>11</b>	Descriptor value [last word]			

## 4.2.4 Link Service TLV descriptors

### 4.2.4.1 Overview

Link Service TLV descriptors are specified in table 6.

**Table 6 – Link Service TLV descriptors**

Tag value	Descriptor	Reference
0000 0000h	Reserved	
0000 0001h	Link Service Request Information	4.2.4.2
0000 0002h	Reserved	
0000 0003h	N_Port_ID descriptor	4.2.4.3
0001 0000h	SFP Diagnostics descriptor	4.3.49.5.1
0001 0001h	Port Speed descriptor	4.3.49.5.1
0001 0002h	Link Error Status Block descriptor	4.3.49.5.2
0001 0003h	Port Names descriptor	4.3.49.5.3
0001 0004h	QSFP Diagnostics descriptor	4.3.49.5.5
0001 0005h	FEC Status descriptor	4.3.49.5.6
0001 0006h	Buffer Credit descriptor	4.3.49.5.7
0001 0007h	Optical Element Data descriptor	4.3.49.5.8
0001 0008h	Optical Product Data descriptor	4.3.49.5.9
0001 0009h	Priority Range Descriptor	4.3.49
0001 000Ah	VEM ID Descriptor	4.3.50
0001 000Bh	Instantiated VE Mapping Descriptor	4.3.50
0001 000Ch	Deinstantiated VE Mapping Descriptor	4.3.50
All other values	Reserved	

### 4.2.4.2 Link Service Request Information descriptor

If Link Service TLV format requests are used, then the Link Service Request Information descriptor shall be the first Link Service TLV descriptor in a Link Service LS\_ACC reply sequence.



The format of the Link Service Request Information descriptor is specified in table 7.

**Table 7 – Link Service Request Information descriptor format**

Bits Word	31 .. 24	23 .. 16	15 .. 08	07 .. 00
0	Descriptor tag = 0000 0001h			
1	Descriptor length = 4			
n	Request payload word 0 value			

**Request payload word 0 value:** contains the value of word 0 (i.e., the ELS word that contains the command code) specified in the associated Link Service request.

#### 4.2.4.3 N\_Port\_ID Descriptor

The format of the N\_Port\_ID descriptor is shown in table 8. The N\_Port\_ID descriptor contains a single N\_Port ID.

**Table 8 – N\_Port\_ID Descriptor**

Bits Word	31 .. 24	23 .. 16	15 .. 08	07 .. 00
0	N_Port_ID Descriptor tag = 00000 0003h			
1	N_Port_ID Descriptor Length (4)			
2	Reserved	N_Port_ID		

### 4.3 Extended Link Service requests

#### 4.3.1 Introduction

A Sequence Initiator shall transmit an ELS Sequence in order to solicit the destination Nx\_Port to perform a link-level function or service. Unless otherwise noted, Extended Link Service requests shall not be issued prior to completion of N\_Port Login. Table 9 applies to ELSs sent to or received by all valid addresses, including well known addresses. FLOGI is required before any other ELS if a Fabric is present.

The LFA is used as the destination ID (D\_ID) in the LINIT and LSTS ELS Request Sequences, and is used as the source ID (S\_ID) in the Reply Sequences. No other Sequences shall be directed to a LFA.

Table 9 – ELS\_Command codes

Value (Bits 31-24)	Description	Abbr.	Reference	N_Port Login Required	TLV Format
01h	Link Service Reject	LS_RJT	4.4.4	N/A	No
02h	Link Service Accept	LS_ACC	4.4.2	N/A	No
03h	N_Port Login	PLOGI	4.3.7	No	No
04h	F_Port Login	FLOGI	4.3.7	No	No
05h	Logout	LOGO	4.3.8	No	No
0Ah	Request Sequence Initiative	RSI	4.3.12	Yes	No
0Bh	Establish Streaming	ESTS	4.3.6	Yes	No
0Ch	Estimate Credit	ESTC	4.3.5	Yes	No
0Dh	Advise Credit	ADVC	4.3.3	Yes	No
0Eh	Read Timeout Value	RTV	4.3.10	Yes	No
0Fh	Read Link Error Status Block	RLS	4.3.9	Yes	No
10h	Echo	ECHO	4.3.4	No	No
11h	Test	TEST	4.3.13	Yes	No
12h	Reinstate Recovery Qualifier	RRQ	4.3.11	Yes	No
13h	Read Exchange Concise	REC	4.3.37	Yes	No
14h	Reserved for legacy implementations <sup>a</sup>				
18h	Read Diagnostic Parameters	RDP	4.3.49	No	Yes
20h	Process Login	PRLI	4.3.19	Yes	No
21h	Process Logout	PRLO	4.3.20	Yes	No
23h	Test Process Login State	TPLS	4.3.21	Yes	No

<sup>a</sup> Some early implementations of FCP-2 may have used the value 14h for SRR (Sequence Retransmission Request). This code is permanently reserved in this standard to avoid conflicts with such implementations. See FCP-3 for the standard implementation of SRR as an FC-4 Link Service.

<sup>b</sup> N\_Port Login required if the D\_ID is the N\_Port\_ID of an N\_Port. N\_Port Login not required if the D\_ID is the F\_Port Controller.

**Table 9 – ELS\_Command codes (Continued)**

Value (Bits 31-24)	Description	Abbr.	Reference	N_Port Login Required	TLV Format
24h	Third Party Process Logout	TPRLO	4.3.28	Yes	No
50h	Discover N_Port Service Parameters	PDISC	4.3.25	Yes	No
51h	Discover F_Port Service Parameters	FDISC	4.3.26	Yes	No
52h	Discover Address	ADISC	4.3.27	Yes	No
58h	Report Port Buffer Condition	RPBC	4.3.31	Yes	No
60h	Fabric Address Notification	FAN	4.3.14	No	No
61h	Registered State Change Notification	RSCN	4.3.17	No	No
62h	State Change Registration	SCR	4.3.18	No	No
63h	Report node FC-4 Types	RNFT	4.3.32	Yes	No
68h	Clock Synchronization Request	CSR	4.3.29	No	No
69h	Clock Synchronization Update	CSU	4.3.30	No	No
70h	Loop Initialize	LINIT	4.3.15	No	No
71h	Loop Port Control - obsolete	LPC	N/A	No	No
72h	Loop Status	LSTS	4.3.16	No	No
77h	Vendor Specific			N/A	
78h	Request node Identification Data	RNID	4.3.22	No	No
79h	Registered Link Incident Report	RLIR	4.3.23	Yes	No
7Ah	Link Incident Record Registration	LIRR	4.3.24	Yes	No
7Bh	Scan Remote Loop	SRL	4.3.33	Yes	No
7Ch	Set Bit-error Reporting Parameters	SBRP	4.3.34	Yes	No
7Dh	Report Port Speed Capabilities	RPSC	4.3.36	Yes	No

<sup>a</sup> Some early implementations of FCP-2 may have used the value 14h for SRR (Sequence Retransmission Request). This code is permanently reserved in this standard to avoid conflicts with such implementations. See FCP-3 for the standard implementation of SRR as an FC-4 Link Service.

<sup>b</sup> N\_Port Login required if the D\_ID is the N\_Port\_ID of an N\_Port. N\_Port Login not required if the D\_ID is the F\_Port Controller.

**Table 9 – ELS\_Command codes (Continued)**

Value (Bits 31-24)	Description	Abbr.	Reference	N_Port Login Required	TLV Format
7Eh	Query Security Attributes	QSA	4.3.35	No	No
7Fh	Exchange Virtual Fabrics Parameters	EVFP	4.3.38	N/A	No
80h	Link Keep Alive	LKA	4.3.39	No	No
81h	Link Cable Beacon	LCB	4.3.40	No	No
90h	Authentication ELS	AUTH_ELS	see FC-SP-2	see FC-SP-2	No
97h	Request Fabric Change Notification	RFCN	4.3.41	No	No
A0h	Define FFI Domain Topology Map	FFI_DTM	4.3.42	Yes	No
A1h	Request FFI Domain Topology Map	FFI_RTM	4.3.43	Yes	No
A2h	FFI AE Principal Switch Selector	FFI_PSS	4.3.44	Yes	No
A3h	FFI Map Update Registration	FFI_MUR	4.3.45	Yes	No
A4h	FFI Registered Map Update Notification	FFI_RMUN	4.3.46	Yes	No
A5h	FFI Suspend Map Updates	FFI_SMU	4.3.47	Yes	No
A6h	FFI Resume Map Updates	FFI_RMU	4.3.48	Yes	No
B0h	Query Fabric Priority Allocation	QFPA	4.3.49	No	Yes
B1h	Update Virtual Entity Mappings	UVEM	4.3.50	<sup>b</sup>	Yes
Others	Reserved				

<sup>a</sup> Some early implementations of FCP-2 may have used the value 14h for SRR (Sequence Retransmission Request). This code is permanently reserved in this standard to avoid conflicts with such implementations. See FCP-3 for the standard implementation of SRR as an FC-4 Link Service.

<sup>b</sup> N\_Port Login required if the D\_ID is the N\_Port\_ID of an N\_Port. N\_Port Login not required if the D\_ID is the F\_Port Controller.

An ELS Protocol is composed of an ELS request Sequence and an ELS Reply Sequence. The last Data frame of an ELS request Sequence shall transfer the Sequence Initiative to the Recipient in order to allow the reply to be transmitted (see FC-FS-3). If an ELS request Sequence is transmitted without the transfer of Sequence Initiative, the Recipient shall abort the Exchange and not perform the request.

The following ELS requests and their replies shall be supported by an Nx\_Port (all others are optional for purposes of this standard, other standards or Technical Reports may require further ELS support):

- a) FLOGI;
- b) PLOGI; and
- c) LOGO.

An Nx\_Port receiving an ELS request shall respond to it in accord with table 10, depending on its N\_Port Login state with the Nx\_Port sending the ELS request and the PLOGI requirement for the ELS specified in table 9.

**Table 10 – Responses to Received ELSs**

N_Port Login Required? (see table 9)	Logged in with Source N_Port?	
	Yes	No
Yes	Respond as appropriate for the ELS and the current state of the Nx_Port	If a reply sequence is defined for the ELS, originate a LOGO ELS Exchange to the sender of the received ELS or reply with an LS_RJT ELS Sequence with a reason code of “Unable to perform command request” and a reason code explanation of “N_Port Login required”. If a reply sequence is not defined for the ELS, it shall be discarded
No	Respond as appropriate for the ELS and the current state of the Nx_Port.	Respond as appropriate for the ELS and the current state of the Nx_Port.

An Nx\_Port is not required to generate and send the PLOGI ELS request. However, if an Nx\_Port receives a PLOGI ELS request, the Nx\_Port shall respond with a LS\_ACC Link Service Reply, or with LS\_RJT. LS\_RJT shall not be issued with a reason code of “Command not supported” in response to a PLOGI.

NOTE 1 – If an Nx\_Port that does not generate PLOGI, is in a point-to-point topology, and has an N\_Port\_Name greater than the other Nx\_Port's, the other Nx\_Port may timeout, waiting to receive PLOGI.

It is possible for the RSI ELS to collide with another Nx\_Port involved in the same target Exchange (e.g. Nx\_Port (A) may transmit an RSI request to Nx\_port (B) at the same time that Nx\_Port (B) transmits an RSI request to Nx\_Port (A) for the same target Exchange).

If such an instance occurs, the Originator Nx\_Port of the target Exchange shall reject the RSI request sequence with an LS\_RJT with a reason code of “command already in progress”. The Responder Nx\_Port of the target Exchange shall honor and process the RSI request Sequence normally.

**4.3.2 Sequence and Exchange management**

Extended Link Service communication shall observe all relevant rules of FC-FS-3.

All ELS requests, excluding ESTS, ESTC, and ADVC, and the corresponding replies shall be performed within a single Exchange, intended exclusively for the purpose of ELS processing (see FC-FS-3 for the procedure using ESTS, ESTC, and ADVC). The Advise Credit request may also be performed in a separate Exchange. Most ELS protocols are performed as a two Sequence Exchange. Each of these two Sequence Exchanges consist of a request Sequence by the Originator, transfer of

Sequence Initiative, and a reply Sequence from the Responder that terminates the Exchange by setting the Last\_Sequence bit (bit 20) in F\_CTL.

Unless otherwise specified for a specific link service more than one frame may be used to form a request or reply Sequence.

The following rules regarding Sequence and Exchange management apply to ELSs in addition to the rules specified in FC-FS-3:

- a) Request and Reply Sequences may be sent in any class of service;
- b) Reply frames and Sequences shall be transmitted in the same class as the request;
- c) If Login has not been completed successfully, the default Login values shall be used;
- d) If Login has completed successfully, the Originator of the Exchange shall use the Discard multiple Sequences Error Policy for all ELS Exchanges (see FC-FS-3);
- e) The Originator of an ELS Exchange shall detect an Exchange error following Sequence Initiative transfer if the Reply Sequence is not received within a timeout interval of  $2 \times R\_A\_TOV$ ;
- f) Unless otherwise specified (see 4.3.7, 4.3.8, and 4.3.26), if the Exchange Originator of an ELS Exchange detects an Exchange error, it shall abort the Exchange using ABTS-LS and retry the protocol of the aborted Exchange with a different Exchange;
- g) If the Sequence Initiator aborts a Sequence using ABTS due to receiving an ACK with the Abort Sequence bits set to 01b, the Sequence Initiator shall retry the Sequence after the BA\_ACC is received for the aborted Sequence one time only. If the retry fails, the ELS Exchange shall be aborted using ABTS-LS;
- h) If the Sequence Initiator attempts to abort a Sequence using ABTS and it detects an E\_D\_TOV waiting for the ACK frame in response to the ABTS, it shall abort the Exchange using ABTS-LS, if conditions permit, and retry the original ELS with a different Exchange; and
- i) If the Sequence Initiator attempts to abort a Sequence using ABTS-LS and it detects an E\_D\_TOV waiting for the ACK frame in response to the ABTS-LS, it may retry the original ELS with a different Exchange.

### **4.3.3 Advise Credit (ADVC)**

#### **4.3.3.1 Description**

The ADVC ELS is used to advise the destination Nx\_Port of the estimated end-to-end Credit that the source Nx\_Port requests to be allocated. The ADVC ELS request shall be a separate Sequence. It may also be requested in a separate Exchange. See FC-FS-3 for the usage of this ELS. The ADVC request may also be used independently from the Estimate Credit procedure (see FC-FS-3).

#### **4.3.3.2 Protocol**

- a) Advise Credit Request Sequence
- b) LS\_ACC or LS\_RJT Reply Sequence

**4.3.3.3 Request Sequence**

**Addressing:** The S\_ID field designates the source Nx\_Port requesting Credit revision. The D\_ID field designates the destination Nx\_Port.

**Payload:** The format of the Payload is shown in table 11. The Payload shall contain the requested end-to-end Credit in the end-to-end Credit field of the appropriate Class Service Parameters (see 6.6.5) as indicated by the Class Validity bit. For each class in which a revised end-to-end Credit is requested, the Class Validity bit shall be set to one. The recipient shall ignore the other Service Parameter fields.

**Table 11 – ADVC Payload**

Bits Word	31 .. 24	23 .. 16	15 .. 08	07 .. 00	
0	ADVC (0Dh)	00h	00h	00h	
1	MSB	<b>Common Service Parameters (16 bytes)</b>			
..					
4					LSB
5	MSB				<b>N_Port_Name (8 bytes)</b>
6		LSB			
7	MSB	<b>Node_Name (8 bytes)</b>			
8					LSB
9	MSB	<b>Obsolete (16 bytes)</b>			
..					
12					LSB
13	MSB				<b>Class 2 Service Parameters (16 bytes)</b>
..					
16		LSB			
17	MSB	<b>Class 3 Service Parameters (16 bytes)</b>			
..					
20					LSB
21	MSB				<b>Reserved (16 bytes)</b>
..					
24		LSB			
25	MSB	<b>Vendor Version Level (16 bytes)</b>			
..					
28					LSB

**4.3.3.4 Reply Sequence**

**LS\_RJT:** LS\_RJT signifies rejection of the ADVC command.

**LS\_ACC:** LS\_ACC signifies successful completion of the ADVC function and permanently replaces the end-to-end Credit in effect for the current N\_Port Login.

The format of the LS\_ACC Payload is shown in table 12. The Payload shall contain the revised end-to-end Credit allocated in the Credit field for the appropriate Class Service Parameters as indicated by the Class Validity bit. The revised end-to-end Credit shall replace the end-to-end Credit for the current Login for the Nx\_Port transmitting the LS\_ACC Sequence (see 6). For each class in which a revised end-to-end Credit is updated, the Class Validity bit shall be set to one. The recipient shall ignore the other Service Parameter fields. This revised end to-end Credit value is determined by the destination Nx\_Port based on its buffering scheme, buffer management, buffer availability, and Nx\_Port processing time (see FC-FS-3).

**Table 12 – ADVC LS\_ACC Payload**

Bits Word	31 .. 24	23 .. 16	15 .. 08	07 .. 00
0	02h	00h	00h	00h
1	MSB			
..	<b>Common Service Parameters</b> (16 bytes)			
4				LSB
5	MSB			
6	<b>N_Port_Name</b> (8 bytes)			
7				LSB
7	MSB			
8	<b>Node_Name</b> (8 bytes)			
8				LSB



**Table 12 – ADVC LS\_ACC Payload(Continued)**

Bits Word	31 .. 24	23 .. 16	15 .. 08	07 .. 00
9	MSB			
..		<b>Obsolete</b> (16 bytes)		
12				LSB
13	MSB			
..		<b>Class 2 Service Parameters</b> (16 bytes)		
16				LSB
17	MSB			
..		<b>Class 3 Service Parameters</b> (16 bytes)		
20				LSB
21	MSB			
..		<b>Reserved</b> (16 bytes)		
24				LSB
25	MSB			
..		<b>Vendor Version Level</b> (16 bytes)		
28				LSB

#### 4.3.4 Echo (ECHO)

##### 4.3.4.1 Description

The Echo ELS requests the Recipient to transmit the Payload contents that follows the ELS\_Command back to the Initiator of the Echo command in the same order as received using the LS\_ACC Reply Sequence. The Echo ELS Request provides a means to transmit a Data frame and have the Payload content returned for a simple loopback diagnostic function. The Echo command shall be transmitted as a one frame Sequence and the LS\_ACC Reply Sequence is also a one frame Sequence.

##### 4.3.4.2 Protocol

- a) Echo Request Sequence
- b) LS\_ACC or LS\_RJT Reply Sequence

##### 4.3.4.3 Request Sequence

**Addressing:** The D\_ID field designates the destination of the request while the S\_ID field designates the source of the request.

**Payload:** The format of the Payload is shown in table 13. If a Login with the destination Nx\_Port does not exist, the maximum size of the ECHO data field shall be 4 less than the default Buffer-to-Buffer Receive Data\_Field Size (i.e., 124 bytes). If a Login with the destination Nx\_Port exists, the ECHO

data field size is limited by 4 less than the smallest Receive Data\_Field Size supported by the destination Nx\_Port, the Fabric, and the source Nx\_Port for the class of service being used (i.e., the ECHO data field in the LS\_ACC frame shall be equal in size to the ECHO data field size in the ECHO Request Sequence).

**Table 13 – ECHO Payload**

Bits Word	31 .. 24	23 .. 16	15 .. 08	07 .. 00
0	ECHO (10h)	00h	00h	00h
1	MSB			ECHO data
..				(up to max frame length - 4, any byte boundary)
n				LSB

#### 4.3.4.4 Reply Sequence

**LS\_RJT:** LS\_RJT signifies rejection of the ECHO command.

**LS\_ACC:** LS\_ACC signifies successful completion of the ECHO function. The format of the LS\_ACC Payload is shown in table 14. The Payload shall contain the ECHO data contained in the Payload of the ECHO Request frame.

**Table 14 – ECHO LS\_ACC Payload**

Bits Word	31 .. 24	23 .. 16	15 .. 08	07 .. 00
0	02h	00h	00h	00h
1	MSB			ECHO data
..				(up to max frame length - 4, any byte boundary)
n				LSB
				Excludes word 0 of ECHO Payload.

#### 4.3.5 Estimate Credit (ESTC)

##### 4.3.5.1 Description

The ESTC ELS is used to estimate the minimum Credit required to achieve the maximum bandwidth for a given distance between an Nx\_Port pair.

The class of the SOF of the ESTC Request identifies the class for which Credit is being estimated. The destination Nx\_Port shall acknowledge Data frames as specified by its Login parameters. See FC-FS-3 for the usage of this frame.

##### 4.3.5.2 Protocol

- a) Estimate Credit Request Sequence
- b) No Reply Sequence

### 4.3.5.3 Request Sequence

**Addressing:** The S\_ID field designates the source Nx\_Port requesting the Credit estimate. The D\_ID field designates the destination Nx\_Port specified in the Establish Streaming frame.

**Payload:** The format of the Payload is shown in table 15. The first word of the Payload of the first frame of the Sequence shall contain the ELS\_Command code. The content of the Payload after the ELS\_Command and for subsequent frames shall be valid data bytes.

**Table 15 – ESTC Payload**

Bits Word	31 .. 24	23 .. 16	15 .. 08	07 .. 00
0	ESTC (0Ch)	00h	00h	00h
1	MSB			
..	Any data (see FC-FS-3)			
n				LSB

### 4.3.5.4 Reply Sequence

None.

### 4.3.6 Establish Streaming (ESTS)

#### 4.3.6.1 Description

The ESTS ELS requests a temporary allocation of Credit known as Streaming Credit large enough to perform continuous streaming of Data frames. The SOF of the ESTS Request identifies the class for which Credit is being estimated. See FC-FS-3 for the usage of this frame.

#### 4.3.6.2 Protocol

- a) Establish Streaming Request Sequence
- b) LS\_ACC or LS\_RJT Reply Sequence

#### 4.3.6.3 Request Sequence

**Addressing:** The S\_ID field designates the source Nx\_Port requesting Streaming. The D\_ID field designates the destination Nx\_Port addressed.

**Payload:** The format of the Payload is shown in table 16.

**Table 16 – ESTS Payload**

Bits Word	31 .. 24	23 .. 16	15 .. 08	07 .. 00
0	ESTS (0Bh)	00h	00h	00h

**4.3.6.4 Reply Sequence**

**LS\_RJT:** LS\_RJT signifies rejection of the ESTS command

**LS\_ACC:** LS\_ACC signifies successful completion of the ESTS function. The format of the LS\_ACC Payload is shown in table 17. The Payload shall contain Streaming Credit allocated in the Nx\_Port end-to-end Credit field of the appropriate Class Service Parameters (see 6.6.5). The Class Validity bit, if set to one, identifies the class that contains the Streaming Credit. The recipient shall ignore the other Service Parameter fields.

**Table 17 – ESTS LS\_ACC Payload**

Bits Word	31 .. 24	23 .. 16	15 .. 08	07 .. 00
0	02h	00h	00h	00h
1	MSB Common Service Parameters (16 bytes)			_____
4	_____			LSB
5	MSB N_Port_Name (8 bytes)			_____
6	_____			LSB
7	MSB node Name (8 bytes)			_____
8	_____			LSB
9	MSB Obsolete (16 bytes)			_____
..	_____			_____
12	_____			LSB
13	MSB Class 2 Service Parameters (16 bytes)			_____
..	_____			_____
16	_____			LSB
17	MSB Class 3 Service Parameters (16 bytes)			_____
..	_____			_____
20	_____			LSB
21	MSB Reserved (16 bytes)			_____
..	_____			_____
24	_____			LSB
25	MSB Vendor Version Level (16 bytes)			_____
..	_____			_____
28	_____			LSB

### 4.3.7 Login (FLOGI/PLOGI)

#### 4.3.7.1 Description

The FLOGI/PLOGI ELS shall transfer Service Parameters from the initiating Nx\_Port to the Nx\_Port associated with the D\_ID. The FLOGI frame provides the means by which an Nx\_Port may request Login with the Fabric (see 6.2). The PLOGI frame provides the means by which an Nx\_Port may request Login with another Nx\_Port prior to other Data frame transfers (see 6.3).

In order to Login with the Fabric and determine the Fabric operating characteristics, an Nx\_Port shall specify the D\_ID as the F\_Port Controller Well-known address (i.e., FFFFFFFEh).

In order to direct the Login ELS frame to a Fibre Channel Service, an Nx\_Port shall specify the N\_Port\_ID for the Nx\_Port providing the service or the appropriate Well-known address (see FC-FS-3).

If an Nx\_Port receives a Login from an Nx\_Port, all open Sequences and Exchanges with the Nx\_Port performing the Login shall be abnormally terminated.

If the Originator of a Login with the Fabric detects a time out, the FLOGI may be retried in a different Exchange without aborting the previous Exchange with ABTS-LS.

#### 4.3.7.2 Protocol

- a) FLOGI or PLOGI Request Sequence
- b) LS\_ACC or LS\_RJT Reply Sequence

#### 4.3.7.3 Request Sequence

**Addressing:** The S\_ID field designates the source Nx\_Port requesting Login. If unidentified, as in Fabric Login, binary zeros are used. The D\_ID field designates the destination Nx\_Port or F\_Port Controller of the Login.

**Payload:** The format of the Payload is shown in table 181. The Service Parameters are defined in 6.6.

#### 4.3.7.4 Reply Sequence

**LS\_RJT:** LS\_RJT signifies rejection of the FLOGI or PLOGI Request Sequence

**LS\_ACC:** LS\_ACC signifies successful completion of the FLOGI or PLOGI Request Sequence. The format of the LS\_ACC Payload is shown in table 181. The Service Parameters are defined in 6.6.

### 4.3.8 Logout (LOGO)

#### 4.3.8.1 Description

The LOGO ELS provides a method for explicitly removing service between two Nx\_Ports or between an Nx\_Port and a Fabric. Logout releases resources, identifiers, and relationships associated with maintaining service between an Nx\_Port and a destination Nx\_Port or Fabric.

If neither the S\_ID nor D\_ID of a LOGO ELS is the F\_Port Controller (FFFFFFEh), the LOGO requests removal of service between the Nx\_Port assigned to the N\_Port\_ID specified in the LOGO Payload

and the Nx\_Port assigned to the N\_Port\_ID specified in the D\_ID. The N\_Port\_ID in the LOGO Payload may differ from the S\_ID. This allows an Nx\_Port to Logout its old Identifier using a new Identifier after its N\_Port\_ID has changed. Both the source Nx\_Port and the destination Nx\_Port of the Logout Request Sequence shall abnormally terminate all open Exchanges (see 6) that used the N\_Port\_ID indicated in the Payload of the Logout Request Sequence.

If either the S\_ID or D\_ID of a LOGO ELS is the F\_Port Controller (FFFFFFEh), the LOGO ELS requests Fabric logout and release of the previously assigned N\_Port\_ID specified in the LOGO Payload. An Nx\_Port that requests or accepts explicit logout from the Fabric shall implicitly log out the Nx\_Port assigned to the N\_Port\_ID indicated in the Payload of the Logout Request Sequence from all other Nx\_Ports and abnormally terminate all open Exchanges (see 6) that used the N\_Port\_ID indicated in the Payload of the Logout Request Sequence.

If the Originator of a LOGO detects a time out, the LOGO may be retried in a different Exchange without aborting the previous Exchange with ABTS-LS.

**4.3.8.2 Protocol**

- a) Logout Request Sequence
- b) LS\_ACC or LS\_RJT Reply Sequence

**4.3.8.3 Request Sequence**

**Addressing:** For an explicit Nx\_Port Logout, the S\_ID field designates the source N\_Port\_ID of the Nx\_Port requesting Logout and the D\_ID field designates the destination Nx\_Port of the Logout Request. For an explicit Fabric Logout originated by an Nx\_Port, the S\_ID field shall be the N\_Port\_ID of the Nx\_Port to be logged out (i.e., the same as the N\_Port\_ID in the Payload) and the D\_ID shall be the F\_Port Controller Well-known address (i.e., FFFFFFFEh). For an explicit Fabric Logout originated by the Fabric, the S\_ID field shall be the F\_Port Controller Well-known address (i.e., FFFFFFFEh) and the D\_ID shall be the N\_Port\_ID of the Nx\_Port to be logged out (i.e., the same as the N\_Port\_ID in the Payload).

**Payload:** The format of the Payload is shown in table 18.

**Table 18 – LOGO Payload**

Bits Word	31 .. 24	23 .. 16	15 .. 08	07 .. 00
0	LOGO (05h)	00h	00h	00h
1	Reserved	N_Port_ID		
2	MSB		N_Port_Name	
3			(8 bytes) LSB	

**4.3.8.4 Reply Sequence**

**LS\_RJT:** LS\_RJT signifies rejection of the LOGO command.

**LS\_ACC:** LS\_ACC signifies that service has been removed for the N\_Port\_ID indicated in the payload of the LOGO ELS. If the LOGO ELS requested Fabric Logout, LS\_ACC signifies that the

N\_Port\_ID specified in the Payload of the LOGO ELS has been logged out from the Fabric and released. The format of the LS\_ACC Payload is shown in table 19.

**Table 19 – LOGO LS\_ACC Payload**

Bits Word	31 .. 24	23 .. 16	15 .. 08	07 .. 00
0	02h	00h	00h	00h

### 4.3.9 Read Link Error Status Block (RLS)

#### 4.3.9.1 Description

The RLS ELS requests an FC\_Port to return the identified Link Error Status Block (LESB) associated with the Port\_ID specified in the Payload. This provides the Nx\_Port transmitting the request with information regarding Link Errors detected within the designated FC\_Port.

#### 4.3.9.2 Protocol

- a) Read Link Error Status Request Sequence
- b) LS\_ACC or LS\_RJT Reply Sequence

#### 4.3.9.3 Request Sequence

**Addressing:** The S\_ID field designates the source Nx\_Port requesting the LESB. The D\_ID field shall be set as follows:

- a) to any Domain Controller well known address (FFFCxxh);
- b) to the F\_Port Controller Well-known address (FFFFEh); or
- c) to any Nx\_Port logged in with the S\_ID address.

**Payload:** The format of the Payload is shown in table 20.

**Table 20 – RLS Payload**

Bits Word	31 .. 24	23 .. 16	15 .. 08	07 .. 00
0	RLS (0Fh)	00h	00h	00h
1	Reserved	N_Port_ID		

The requested LESB is identified as follows:

- a) If the D\_ID is a Domain Controller well known address (FFFCxxh), the N\_Port\_ID field shall be set to an N\_Port\_ID within the associated domain. The LESB requested is for the F\_Port that the N\_Port\_ID is logged in with;
- b) if the D\_ID is the F\_Port Controller Well-known address (FFFFEh), the N\_Port\_ID field is not meaningful and the LESB request is for the local Fx\_Port that the S\_ID is logged in with; or

- c) for all other D\_IDs, the N\_Port\_ID field is not meaningful and the LESB requested is for the Nx\_Port assigned to the D\_ID.

**4.3.9.4 Reply Sequence**

**LS\_RJT:** LS\_RJT signifies rejection of the RLS command. The LS\_RJT reason code and reason code explanation are set as follows:

- a) If an FC\_Port does not support the LESB, it shall reply with an LS\_RJT specifying a reason code of “Unable to perform command request” (09h) and should respond with a reason code explanation of “Request not supported” (2Ch); or
- b) if the N\_Port\_ID is not logged in with an F\_Port within the domain, the Domain Controller should reply with an LS\_RJT specifying a reason code of “Logical error” (03h) and reason code explanation “Invalid N\_Port\_ID” (1Fh).

**LS\_ACC:** LS\_ACC signifies that the FC\_Port has transmitted the requested data. The format of the LS\_ACC Payload is shown in table 21. The format of the Link Error Status Block is specified in FC-FS-3.

**Table 21 – RLS LS\_ACC Payload**

Bits Word	31 .. 24	23 .. 16	15 .. 08	07 .. 00
0	02h	00h	00h	00h
1	MSB			
..	Link Error Status Block (see FC-FS-3) (24 bytes)			
6				LSB

**4.3.10 Read Timeout Value (RTV)**

**4.3.10.1 Description**

The RTV ELS requests an FC\_Port to return the R\_A\_TOV and the E\_D\_TOV in the LS\_ACC. The LS\_ACC returns the value that the FC\_Port uses for R\_T\_TOV. This provides the FC\_Port transmitting the RTV ELS with information regarding these values from another FC\_Port. Usage of R\_A\_TOV, E\_D\_TOV and R\_T\_TOV requirements are given in FC-FS-3.

**4.3.10.2 Protocol**

- a) Read Timeout Value (RTV) Request Sequence
- b) LS\_ACC or LS\_RJT Reply Sequence

**4.3.10.3 Request Sequence**

**Addressing:** The S\_ID field designates the source Nx\_Port requesting the timeout interval values. The D\_ID field designates the destination FC\_Port to which the request is being made.



**Payload:** The format of the Payload is shown in table 22.

**Table 22 – RTV Payload**

Bits Word	31 .. 24	23 .. 16	15 .. 08	07 .. 00
0	RTV (0Eh)	00h	00h	00h

#### 4.3.10.4 Reply Sequence

**LS\_RJT:** LS\_RJT signifies rejection of the RTV command.

**LS\_ACC:** LS\_ACC returns the requested R\_A\_TOV and E\_D\_TOV values. The format of the LS\_ACC Payload is shown in table 23. E\_D\_TOV Timeout values are specified as a count of either 1 ms or 1 ns increments, depending on the setting of the E\_D\_TOV Resolution (see FC-FS-3).

**Table 23 – RTV LS\_ACC Payload**

Bits Word	31 .. 24	23 .. 16	15 .. 08	07 .. 00
0	02h	00h	00h	00h
1	Resource_Allocation_Timeout Value (R_A_TOV) (see FC-FS-3)			
2	Error_Detect_Timeout Value (E_D_TOV) (see FC-FS-3)			
3	Timeout Qualifier			

The Timeout Qualifier word is defined as follows:

- a) Bits 31-27: Reserved;
- b) Bit 26: E\_D\_TOV Resolution:

If the E\_D\_TOV Resolution bit is zero, the value specified in the E\_D\_TOV field shall indicate a count of 1 ms increments. If the E\_D\_TOV Resolution bit is one, the value specified in the E\_D\_TOV field shall indicate a count of 1 ns increments;

- c) Bits 25-20: Reserved;
- d) Bit 19: R\_T\_TOV Value;

If this bit is set to zero, the value of R\_T\_TOV shall be the default value of 100 milliseconds. If it is set to one, the value of R\_T\_TOV shall be 100 microseconds; and

- e) Bits 18-0: Reserved.

#### 4.3.11 Reinstatement Recovery Qualifier (RRQ)

##### 4.3.11.1 Description

The RRQ ELS shall be used to notify the destination Nx\_Port that the Recovery\_Qualifier shall be available for reuse. The Recovery\_Qualifier (S\_ID, D\_ID, OX\_ID, RX\_ID, and low SEQ\_CNT minus

high SEQ\_CNT) shall be associated with an Exchange in which the Abort Sequence or Abort Exchange was previously performed.

In the case of Abort Exchange (i.e., ABTS-LS), the ESB and Recovery\_Qualifier are immediately available for reuse. In the case of Abort Sequence Protocol, the Recovery\_Qualifier is purged.

A request to Reinstate the Recovery\_Qualifier shall only be accepted if the Originator Nx\_Port N\_Port\_ID or the Responder Nx\_Port N\_Port\_ID of the target Exchange is the same as the N\_Port\_ID of the Nx\_Port that makes the request. If the RRQ Request is not accepted, an LS\_RJT with reason code "Unable to perform command request" and reason code explanation "Invalid Originator S\_ID" shall be returned.

A separate Exchange shall be used to reinstate the Recovery\_Qualifier. The Payload shall contain the OX\_ID and RX\_ID for the Exchange Recovery\_Qualifier, in addition to the S\_ID of the Nx\_Port that originated the Exchange being aborted. Resources associated with the OX\_ID in the Originator, and with the RX\_ID in the Responder, shall be released following transmission and reception of the LS\_ACC reply Sequence if the Exchange had been aborted with ABTS-LS.

Both the Originator and Responder shall ensure that the OX\_ID and RX\_ID pair being terminated is currently associated with the OX\_ID and RX\_ID pair specified in the RRQ Request.

The Recovery\_Qualifier range shall be timed out for an R\_A\_TOV timeout period (i.e., RRQ shall not be transmitted until an R\_A\_TOV timeout period after BA\_ACC for ABTS has been received) by the Nx\_Port that transmitted and successfully completed the ABTS frame.

#### 4.3.11.2 Protocol

- a) Reinstate Recovery Qualifier Request Sequence
- b) LS\_ACC or LS\_RJT Reply Sequence

#### 4.3.11.3 Request Sequence

**Addressing:** The D\_ID field designates the destination Nx\_Port of the RRQ Request Sequence while the S\_ID field designates the source Nx\_Port that is requesting that the Recovery\_Qualifier be reinstated.

**Exchange:** A separate Exchange is required.

**SEQ\_ID and SEQ\_CNT:** The SEQ\_ID and the SEQ\_CNT shall be appropriate for an open Sequence.

**Payload:** The format of the Payload is shown in table 24.

**Table 24 – RRQ Payload**

Bits Word	31 .. 24	23 .. 16	15 .. 08	07 .. 00
0	RRQ (12h)	00h	00h	00h
1	Reserved	Exchange Originator S_ID		
2	OX_ID		RX_ID	
3	MSB			
..	Obsolete (32 bytes)			
10	LSB			

#### 4.3.11.4 Reply Sequence

**LS\_RJT:** LS\_RJT signifies rejection of the RRQ command.

**LS\_ACC:** LS\_ACC signifies that the destination Nx\_Port reinstated the Recovery\_Qualifier. The format of the LS\_ACC Payload is shown in table 25.

**Table 25 – RRQ LS\_ACC Payload**

Bits Word	31 .. 24	23 .. 16	15 .. 08	07 .. 00
0	02h	00h	00h	00h

#### 4.3.12 Request Sequence Initiative (RSI)

##### 4.3.12.1 Description

The RSI ELS is used to request that Sequence Initiative be passed to the Sequence Recipient of an Exchange in progress. A request to pass Sequence Initiative shall only be accepted if the Originator Nx\_Port or the Responder Nx\_Port of the target Exchange makes the request. A separate Exchange shall be used to perform the Request Sequence Initiative. The Payload shall contain the OX\_ID and RX\_ID for the target Exchange, in addition to the S\_ID of the Nx\_Port that originated the Exchange. The LS\_ACC Reply is sent subsequent to the transfer of Sequence Initiative on the target Exchange.

Transmission of RSI is allowed while the identified Exchange is open. Both the Originator and Responder shall ensure that the OX\_ID and RX\_ID pair for which Sequence Initiative is being passed are currently associated with the OX\_ID and RX\_ID pair specified in the RSI Request.

If there is a Sequence active for the target Exchange, the Sequence Initiator of the active Sequence of the target Exchange shall terminate them and transfer Sequence Initiative as follows:

- a) If there is an active Sequence for which the last Data frame has not been transmitted, the Sequence Initiator of the target Exchange shall terminate the Sequence by transmitting a Data frame with the End\_Sequence and Sequence Initiative bits set to one in F\_CTL; and

- b) If there are no Data frames to be sent for the active Sequence, the Sequence Initiator of the target Exchange shall transmit a NOP Basic Link Service frame (see FC-FS-3) with the End\_Sequence and Sequence Initiative bits set to one in F\_CTL.

If there is no Sequence active, the Sequence Initiator of the target Exchange shall transfer Sequence Initiative by initiating a new Sequence consisting of a single NOP Basic Link Service frame (a one frame Sequence) with the End\_Sequence and Sequence Initiative bits set to 1 in F\_CTL.

The LS\_ACC to the Exchange requesting Sequence Initiative shall be transmitted after Sequence Initiative has been passed (see FC-FS-3) on the target Exchange.

**4.3.12.2 Protocol**

- a) Request Sequence Initiative Request Sequence
- b) LS\_ACC or LS\_RJT Reply Sequence

**4.3.12.3 Request Sequence**

**Addressing:** The D\_ID field designates the destination Nx\_Port of the Exchange for which Sequence Initiative is being requested and the S\_ID field designates the source Nx\_Port that is requesting Sequence Initiative.

**Exchange:** A separate Exchange is required other than the Exchange for which Sequence Initiative is being requested in order to properly track status.

**SEQ\_ID and SEQ\_CNT:** The SEQ\_ID and the SEQ\_CNT shall be appropriate for an open Sequence.

**Payload:** The format of the Payload is shown in table 26.

**Table 26 – RSI Payload**

Bits Word	31 .. 24	23 .. 16	15 .. 08	07 .. 00
0	RSI (0Ah)	00h	00h	00h
1	Reserved	Originator S_ID		
2	OX_ID		RX_ID	
3	MSB			
..			Obsolete (32 bytes)	
10			LSB	

**4.3.12.4 Reply Sequence**

**LS\_RJT:** LS\_RJT signifies rejection of the RSI command.

**LS\_ACC:** LS\_ACC signifies that the destination Nx\_Port has transferred the Sequence Initiative for the target Exchange. The format of the LS\_ACC Payload is shown in table 27.

**Table 27 – RSI LS\_ACC Payload**

Bits Word	31 .. 24	23 .. 16	15 .. 08	07 .. 00
0	02h	00h	00h	00h

### 4.3.13 Test (TEST)

#### 4.3.13.1 Description

The TEST ELS shall consist of a single Sequence being transmitted from the Sequence Initiator to the Sequence Recipient. The Test Request may be used in diagnostic or testing procedures to provide system loading. There is no Reply Sequence. The Payload may consist of any frame size up to the maximum allowable for the class and other normal Sequence and frame limitations.

#### 4.3.13.2 Protocol

- a) Test Request Sequence
- b) No Reply Sequence

#### 4.3.13.3 Request Sequence

**Addressing:** The D\_ID field designates the destination of the request while the S\_ID field designates the source of the request.

**Payload:** The format of the Payload is shown in table 28.

**Table 28 – TEST Payload**

Bits Word	31 .. 24	23 .. 16	15 .. 08	07 .. 00
0	TEST (11h)	00h	00h	00h
1	MSB	TEST data		
..		(up to max Data_Field size - 4, any byte boundary)		
n				LSB

The Payload size is limited by the smallest Data\_Field size supported by the destination Nx\_Port and the Fabric for the class being used.

#### 4.3.13.4 Reply Sequence

none

**4.3.14 Fabric Address Notification (FAN)**

**4.3.14.1 Description**

The FAN ELS shall be sent by an F\_Port Controller (FFFFFFEh) to all known previously logged in (via FLOGI) attached NL\_Ports following an initialization event. This initialization event is typically Loop Initialization on an Arbitrated Loop, though other events that may cause a port to change its ID may also be considered. The F\_Port Controller shall report the F\_Port\_Name and Fabric\_Name as they were reported in the prior FLOGI, and shall report the current Loop Fabric Address. The F\_Port Controller shall send this ELS using the default Login parameters (i.e., the parameters that are in effect prior to a FLOGI Request).

The attached ports may use this information to authenticate active Exchanges and operating parameters (e.g., Login BB\_Credit).

The F\_Port Controller shall report identical information to all attached NL\_Ports. If the information changes in any way before the F\_Port Controller is able to send the service to all attached ports, the F\_Port Controller shall begin a new initialization event.

The attached NL\_Ports shall not initiate a Reply Sequence to this ELS.

**4.3.14.2 Protocol**

- a) Fabric Address Notification Request Sequence
- b) No Reply Sequence

**4.3.14.3 Request Sequence**

**Addressing:** The S\_ID is the Fabric Controller (FFFFFFEh) sending the FAN. The D\_ID is the NL\_Port receiving the FAN.

**Payload:** The format of the FAN Request Payload is shown in table 29.

**Table 29 – FAN Payload**

Bits Word	31 .. 24	23 .. 16	15 .. 08	07 .. 00
0	FAN (60h)	00h	00h	00h
1	Reserved	Loop Fabric Address		
2	MSB		F_Port_Name	
3			(8 bytes) LSB	
4	MSB		Fabric_Name	
5			(8 bytes) LSB	

**4.3.14.4 Reply Sequence**

none

**4.3.15 Loop Initialize (LINIT)**

**4.3.15.1 Description**

The LINIT ELS requests the start of Loop Initialization on a designated loop. The FL\_Port connected to the loop addressed by the Loop Fabric Address shall originate a LIP of the type specified in the Payload and begin the Initialization Process as described in FC-AL-2. The LS\_ACC Reply Sequence shall not be initiated before the FL\_Port has transitioned from the OPEN-INIT to MONITORING State, and the Fabric Controller has completed sending any FAN ELS (see FC-AL-2). If the LINIT ELS is received by a non-FL\_Port, the port shall originate an LS\_RJT with a reason code of “Command not supported”.

**4.3.15.2 Protocol**

- a) Loop Initialize Request Sequence
- b) LS\_ACC or LS\_RJT Reply Sequence

**4.3.15.3 Request Sequence**

**Addressing:** The S\_ID designates the Nx\_Port requesting Loop Initialization of the loop. The D\_ID field shall be the Loop Fabric Address (LFA) of the loop to be initialized.

**Payload:** The format of the LINIT Request Payload is shown in table 30.

**Table 30 – LINIT Payload**

Bits Word	31 .. 24	23 .. 16	15 .. 08	07 .. 00
0	LINIT (70h)	00h	00h	00h
1	Reserved	Initialization Function	LIP byte 3	LIP byte 4

The Initialization Function field defines modifications of the initialization to be performed. The format of the Initialization Function is shown in table 31.

**Table 31 – Initialization Function**

Function	Value
Normal Initialization - The Fabric determines the best method by which to complete the initialization.	0
Force Login - The L_bit shall be set in the Loop Initialization Soft Assigned (LISA) Sequence to force all affected L_Ports to perform FLOGI.	1
Reserved	2 - 255

The LIP Byte 3 field is the 3rd byte of the LIP to be originated. The LIP Byte 4 field is the 4th byte of the LIP Primitive Sequence to be originated. LIP Byte 3 and LIP Byte 4 should only be set to values permitted by FC-AL-2.

**4.3.15.4 Reply Sequence**

**LS\_RJT:** LS\_RJT signifies the rejection of the LINIT command

**LS\_ACC:** LS\_ACC signifies acceptance of the LINIT Request and completion of Loop Initialization. The format of the LS\_ACC Payload is shown in table 32.

**Table 32 – LINIT LS\_ACC Payload**

Bits Word	31 .. 24	23 .. 16	15 .. 08	07 .. 00
0	02h	00h	00h	00h
1	Reserved			Status

The format of the Status field is shown in table 33.

**Table 33 – LINIT Status**

State	Value
Reserved	0
Success - The requested function was completed.	1
Failure - The requested function could not be completed.	2
Reserved	3-255

**4.3.16 Loop Status (LSTS)**

**4.3.16.1 Description**

The LSTS ELS is used to request the Fabric Controller to report on the state of the specified loop.

**4.3.16.2 Protocol**

- a) Loop Status Request Sequence
- b) LS\_ACC or LS\_RJT Reply Sequence

**4.3.16.3 Request Sequence**

**Addressing:** The S\_ID is the Nx\_Port requesting status for the specified loop. The D\_ID field shall be the Loop Fabric Address (LFA) of the loop for which status is being requested.

**Payload:** The format of the LSTS Payload is shown in table 34.

**Table 34 – LSTS Payload**

Bits Word	31 .. 24	23 .. 16	15 .. 08	07 .. 00
0	LSTS (72h)	00h	00h	00h



#### 4.3.16.4 Reply Sequence

**LS\_RJT:** LS\_RJT signifies the rejection of the LSTS command.

**LS\_ACC:** LS\_ACC supplies the requested status for the identified Loop. The format of the LS\_ACC Payload is shown in table 35.

**Table 35 – LSTS LS\_ACC Payload**

Bits Word	31 .. 24	23 .. 16	15 .. 08	07 .. 00
0	02h	00h	00h	00h
1	Reserved	Failed Receiver	FC-FLA Compliance Level - obsolete	Loop State
2	MSB			LSB
..	<b>Current Public Loop Devices bit map</b>			
5	(16 bytes)			
6	MSB			LSB
..	<b>Current Private Loop Devices bit map</b>			
9	(16 bytes)			
10	MSB			LSB
..	<b>AL_PA Position Map</b>			
41	(128 bytes)			

The Payload fields are defined as follows:

- a) **Failed Receiver field:** The Failed Receiver field shall contain the AL\_PA of the L\_Port that detected the Loop Failure. This field is valid only if the Loop State indicates a Loop Failure. This field shall be set to 00h if the FL\_Port detected the failure. This field shall be set to F7h if the Fabric Controller is unable to determine the port that detected the failure;
- b) **Compliance Level field:** obsolete;

- c) **Loop State field:** The format of the Loop State field is shown in table 36;

**Table 36 – Loop State**

State	Value
Reserved	0
Online – The loop is not performing Loop Initialization, and no Failure has been detected.	1
Loop Failure - A Loop Failure has been detected. The AL_PA that detected the failure is reported in the Failed Receiver field.	2
Initialization Failure - The FL_Port has not been able to complete Loop Initialization.	3
Initializing - The loop is currently performing Loop Initialization.	4
Reserved	5 - 255

- d) **Current Public Loop Devices:** The format of the Current Public Loop Devices field follows the AL\_PA bit mapped format defined in FC-AL-2. If a bit is set to one in this field, then a Loop Device that has performed FLOGI is present at the identified location. This field is valid only if the value in the Loop State field is Online;
- e) **Current Private Loop Devices:** The format of the Current Private Loop Devices field follows the AL\_PA bit mapped format defined in FC-AL-2. If a bit is set to one in this field, then a Loop Device is present at the identified location. This field is valid only if the value in the Loop State field is Online; and
- f) **AL\_PA Position Map:** The format of the AL\_PA Position Map field follows the AL\_PA position map format defined in FC-AL-2 for the Loop Initialization Loop Position (LILP) Sequence. If Byte 0 of the first word of the AL\_PA position map is set to zero, then no AL\_PA position map is available. This field is valid only if the value in the Loop State field is Online.

#### 4.3.17 Registered State Change Notification (RSCN)

##### 4.3.17.1 Introduction

A RSCN ELS shall be sent to registered Nx\_Ports when an event occurs that may have affected the state of one or more Nx\_Ports, or the ULP state within the Nx\_Port. The term state is used here to refer to any condition of an Nx\_Port that is considered important enough to notify other Nx\_Ports of a change in that condition. The definition of important is specific to an Nx\_Port implementation, but should include the Login state or Link state. The RSCN additionally provides an indication of the change of state that is being reported.

RSCN is intended to provide a timely indication of changes in nodes to avoid the considerable traffic that polling may generate. RSCN may be used to indicate a failed node, allowing the release of resources tied up by the failed node. RSCN may also be used to notify interested nodes of new devices coming online, and of changes within an online node that affect the operation of the system (e.g.,

more storage has become available). The sender of the RSCN Request may coalesce several events into a single report.

A RSCN Request may be sent by the Fabric to notify registered Nx\_Ports of changes detected by the Fabric. The Fabric Controller (FFFFFDh) issues the RSCN Request to the registered Nx\_Ports. An Nx\_Port may also issue a RSCN Request to the Fabric Controller or another Nx\_Port to indicate changes of state within the Nx\_Port that are not otherwise detectable by the Fabric.

The Payload of a RSCN Request includes a list containing the addresses of the affected Nx\_Ports. The RSCN includes a summary indication of the type of state change being reported to assist in analyzing the change. The sending of RSCN between Nx\_Ports, neither of which are the Fabric Controller, is permitted.

Nx\_Ports, which are not the Fabric Controller, that request RSCNs and the Fabric Controller are hereafter called registered Nx\_Ports.

If an Nx\_Port registers for Fabric Detected and Nx\_Port Detected events, then the RSCN Request shall return all affected N\_Port\_ID pages.

#### **4.3.17.2 RSCNs issued by the Fabric Controller**

The Fabric Controller shall issue an RSCN Request to all registered Nx\_Ports for an affected Nx\_Port when the Fabric detects an event. The Fabric Controller shall ensure that any Fabric-provided resources (e.g., the Name Service) have received updates to reflect changes caused by the event, prior to issuing the RSCN for the event. An event may include any of the following:

- a) an implicit Fabric Logout of the affected Nx\_Port, including Loss-of-Signal, NOS, and OLS, or if the Fabric receives a FLOGI that contains new or different information from a port that had already completed FLOGI;
- b) a loop initialization of the affected L\_Port, and the L\_bit was set in the LISA Sequence;
- c) a Fabric Login from an affected Nx\_Port not previously logged in;
- d) the Fabric path between the affected Nx\_Port and any other Nx\_Port has changed (e.g., a change to the Fabric routing tables that affects the ability of the Fabric to deliver frames in order, or an E\_Port initialization or failure);
- e) any other Fabric-detected state change of the affected Nx\_Port;
- f) an affected Nx\_Port issues an RSCN Request to the Fabric Controller; or
- g) a Peer Zone (see FC-GS-7) is created, modified or deleted.

A registered Nx\_Port that receives an RSCN Request may perform any operation to determine the nature of the state change. These operations include the PDISC ELS, the ADISC ELS, a query to the Name Service, or a ULP query. The Fabric may accumulate affected Nx\_Port addresses for subsequent delivery to reduce the volume of RSCN traffic.

If the event was modification, deletion or addition of a Peer Zone, then the RSCN sent shall have an event qualifier of Changed Peer Zone (i.e., 0111b) in an Affected Port\_ID page containing the N\_Port\_ID of the Principal member.

**4.3.17.3 RSCN issued by the affected Nx\_Port**

An Nx\_Port shall issue an RSCN Request to the Fabric Controller or the Nx\_Port that has registered for receipt of RSCN Requests or both when an event is detected by an Nx\_Port. Fabric Controllers are implicitly registered to receive RSCNs after a successful implicit or explicit FLOGI. Unless it is providing a service associated with a well known address an Nx\_Port shall only issue RSCNs with an event qualifier of 2h or 0h. An event may include any of the following:

- a) a failure within the affected Nx\_Port; or
- b) any other important state change of the affected Nx\_Port (e.g., an event defined by a FC-4).

**4.3.17.4 RSCN initiative**

An affected Nx\_Port shall issue one RSCN Request for all state changes that occur prior to the initiation of the RSCN Request; multiple RSCN Requests shall not be queued for initiation. An RSCN Request shall be considered initiated when the SOF of the first frame of the RSCN Request Sequence has been transmitted.

**4.3.17.5 RSCN registration**

An Nx\_Port, including a Well-known Address or Fabric Controller, shall only issue RSCN requests to Nx\_Ports that have registered either explicitly or implicitly with the Nx\_Port to be notified of state changes. These registrations shall be performed using the State Change Registration (SCR) ELS.

**4.3.17.6 Protocol**

- a) RSCN Request Sequence
- b) LS\_ACC or LS\_RJT Reply Sequence

**4.3.17.7 Request Sequence**

**Addressing:** If the Fabric is using RSCN to notify a registered Nx\_Port of a state change (see 4.3.17.2), the S\_ID is the Fabric Controller, (FFFFFFDh) and the D\_ID is the address of the registered Nx\_Port destination. If an affected Nx\_Port is using RSCN to notify the Fabric or a registered Nx\_Port of a state change (see 4.3.17.3), the S\_ID designates either the Nx\_Port indicating a state change to the Fabric Controller or the registered Nx\_Port and the D\_ID is either the Fabric Controller, (FFFFFFDh) or the address of the registered Nx\_Port destination.

**Payload:** The format of the RSCN Request Payload is shown in table 37.

**Table 37 – RSCN Payload**

Bits Word	31 .. 24	23 .. 16	15 .. 08	07 .. 00
0	RSCN (61h)	Page Length (04h)	Payload Length	
1	<b>affected Port_ID pages</b> (1 to 255 pages, 4 bytes each)			
..				
N				

The RSCN Payload fields are defined as follows:

- a) **Page Length:** This field is the length in bytes of an affected Port\_ID page. This value is fixed at 04h;
- b) **Payload Length:** This field is the length in bytes of the entire Payload, inclusive of the word 0. This value shall be a multiple of 4 bytes. The minimum value of this field is 8 bytes. The maximum value of this field is 1024 bytes; and
- c) **Affected Port\_ID Pages:** Each affected Port\_ID page contains the ID of the Nx\_Port, Fabric Controller, E\_Port, domain, or area for which the event was detected. The RSCN Payload shall contain one or more of these pages. The generic format of the affected Port\_ID page is shown in table 38.

**Table 38 – Generic affected Port\_ID page**

Bit in Byte Byte	7	6	5	4	3	2	1	0
<b>0 (Bits 31 - 24)</b>	reserved		RSCN Event Qualifier				Address Format	
<b>1 (Bits 23 - 16)</b>	affected Port_ID byte 1 (Domain)							
<b>2 (Bits 15 - 08)</b>	affected Port_ID byte 2 (Area)							
<b>3 (Bits 07 - 00)</b>	affected Port_ID byte 3 (Port)							

A) **RSCN Event Qualifier:** The RSCN Event Qualifier values are shown in table 39; and

**Table 39 – RSCN Event Qualifier values**

RSCN event Qualifier	Value			
	Bit 5	Bit 4	Bit 3	Bit 2
Event is not specified	0	0	0	0
CHANGED NAME SERVER OBJECT - An object maintained by the Name Server has changed state for the port, area or domain indicated by the affected Port_ID.	0	0	0	1
CHANGED PORT ATTRIBUTE - An internal state of the port specified by the affected Port_ID has changed. The change of state is identified in a protocol specific manner.	0	0	1	0
CHANGED SERVICE OBJECT - An object maintained by the service identified by the well-known address contained in affected Port_ID has changed state. This Event Qualifier value shall not be used by services accessed through N_Port_ID that are not well-known addresses.	0	0	1	1
CHANGED SWITCH CONFIGURATION - Switch configuration has changed for the area or domain specified by the affected Port_ID.	0	1	0	0
REMOVED OBJECT - The port, area or domain indicated by the affected Port_ID is no longer accessible on the Fabric.	0	1	0	1
CHANGED FABRIC NAME - The Fabric_Name has changed for the Fabric. The Address Format shall be set to 3 (i.e., Fabric Address Group).	0	1	1	0
CHANGED PEER ZONE - The Peer Zone that contains the Principal member identified by the affected Port_ID has changed.	0	1	1	1
Reserved	All Other Values			

B) **Address Format:** The format of the Address Format field is shown in table 40.

**Table 40 – Address Format**

Format	Value
Port Address - Bytes 1, 2, and 3 of the affected Port_ID are valid, and indicate a single Nx_Port or service with a well-known address.	0
Area Address Group - Bytes 1 and 2 of the affected Port_ID are valid, and indicates a group of addresses that encompass an Area of E_Port or Nx_Port addresses. Byte 3 shall be zero. Any links and ports within the area may be affected.	1
Domain Address Group - Byte 1 of the affected Port_ID is valid, and indicates a group of addresses that encompass a Domain. Bytes 2 and 3 shall be zero. Any links and ports within the domain may be affected.	2
Fabric Address Group - This format indicates a group of addresses that encompass the entire Fabric of Nx_Port addresses. Bytes 1, 2 and 3 shall be zero. Any links and ports within the area may be affected.	3

#### 4.3.17.8 Reply Sequence

**LS\_RJT:** LS\_RJT signifies the rejection of the RSCN command

**LS\_ACC:** LS\_ACC signifies acceptance of the RSCN Request. The format of the LS\_ACC Payload is shown in table 41.

**Table 41 – RSCN LS\_ACC Payload**

Bits Word	31 .. 24	23 .. 16	15 .. 08	07 .. 00
0	02h	00h	00h	00h

#### 4.3.17.9 RSCN Recovery

If the RSCN sender receives an ABTS in response to the RSCN, then the RSCN sender shall terminate the Exchange with BA\_ACC to the ABTS, and retry the original RSCN with a different Exchange at least once.

NOTE 2 – If the retry is sent immediately, the conditions that caused the ABTS to be sent may still be present, therefore a delay of up to ED\_TOV is recommended before each retry.

#### 4.3.18 State Change Registration (SCR)

##### 4.3.18.1 Description

The SCR ELS requests the Fabric Controller or Nx\_Port to add the Nx\_Port that is sending the SCR Request to the list of Nx\_Ports registered to receive the RSCN ELS.

##### 4.3.18.2 Protocol

- a) State Change Registration Request Sequence

b) LS\_ACC or LS\_RJT Reply Sequence

#### 4.3.18.3 Request Sequence

**Addressing:** The S\_ID designates the Nx\_Port requesting registration for State Change Notification. The D\_ID designates either the Fabric Controller, FFFFFDh, or the address of the Nx\_Port from which RSCNs are desired.

**Payload:** The format of the SCR Request Payload is shown in table 42.

**Table 42 – SCR Payload**

Bits Word	31 .. 24	23 .. 16	15 .. 08	07 .. 00
0	SCR (62h)	00h	00h	00h
	Reserved			Registration Function Bitmap

**Registration Function Bitmap:** The format of the Registration Function Bitmap field is shown in table 43.

**Table 43 – Registration Function Bitmap**

Function	Bit	Field Value
Reserved		0
Obsolete		FFh
Fabric Detected registration - Register to receive all RSCN Requests issued by the Fabric Controller for events detected by the Fabric.	0	01h
Nx_Port Detected registration - Register to receive all RSCN Requests issued for events detected by the affected Nx_Port.	1	02h
Fabric Name Change registration - Register to receive Fabric Name Change RSCN.	2	04h
Peer Zone Change registration - {CWC: Needs a description. }	3	08h
Reserved	4	10h
Reserved	5	20h
Reserved	6	40h
-	7 <sup>a</sup>	N/A
<sup>a</sup> This bit shall be set to zero.		

#### 4.3.18.4 Reply Sequence

**LS\_RJT:** LS\_RJT signifies the rejection of the SCR command.



**LS\_ACC:** LS\_ACC signifies acceptance of the SCR Request and registration for RSCN. The format of the LS\_ACC Payload is shown in table 44.

**Table 44 – SCR LS\_ACC Payload**

Bits Word	31 .. 24	23 .. 16	15 .. 08	07 .. 00
0	02h	00h	00h	00h

#### 4.3.19 Process Login (PRLI)

##### 4.3.19.1 Introduction

The PRLI ELS is used to establish the operating environment between a group of related processes at the originating Nx\_Port and a group of related processes at the responding Nx\_Port (see 7.1).

##### 4.3.19.2 Protocol

- a) Process Login Request Sequence
- b) LS\_ACC or LS\_RJT Reply Sequence

##### 4.3.19.3 Request Sequence

**Addressing:** The S\_ID field designates the Nx\_Port requesting Process Login. The D\_ID field designates the destination Nx\_Port of the Process Login.

**Payload:** The format of the Payload is shown in table 45.

**Table 45 – PRLI Payload**

Bits Word	31 .. 24	23 .. 16	15 .. 08	07 .. 00
0	PRLI (20h)	Page Length	Payload Length	
1	Service Parameter page			
..				
N				

The Payload Field are defined as follows:

- a) **Page length:** Byte 1 of word 0 contains an 8-bit value that specifies the length of the Service Parameter page. The right-most two bits shall be zeros. The minimum Page Length value is 12 (see table 46);
- b) **Payload length:** Bytes 2-3 of word 0 contain a 16-bit value that specifies the length of the PRLI Payload. The right-most two bits shall be zeros. The value specified shall be greater than or equal to 16, and less than or equal to 256 (see table 46); and
- c) **Service parameter page:** Words 1:N of the PRLI Payload contain the Service Parameter page. The Service Parameter page contains Service Parameters for a single image pair and is

associated with either a single FC-4 TYPE or is common to all FC-4 TYPE codes for the specified image pair. The format of PRLI Service Parameter pages is specified in table 46.

**Table 46 – PRLI service parameter page format**

Item	Word	Bit
TYPE Code or Common Service Parameters	0	31-24
TYPE Code Extension	0	23-16
Obsolete	0	15
Obsolete	0	14
Establish Image Pair	0	13
Reserved	0	12-0
Obsolete	1	31-0
Obsolete	2	31-0
Service Parameters (optional per FC-4)	3 - 63 as specified by each FC-4	31-0

The PRLI service parameter page format fields are defined as follows:

- a) **TYPE code or common service parameters:** Identifies the protocol associated with this Service Parameter page. If byte 0 of the first word of a Service Parameter page contains the value 00h, the Service Parameter page contains Service Parameters common to all FC-4 Types at that image pair or Nx\_Port pair. If byte 0 of the first word of a Service Parameter page contains the value other than 00h, the Service Parameter page contains Service Parameters for the FC-4 TYPE indicated;
- b) **TYPE code extension:** Reserved for future use;
- c) **Establish Image Pair:**
  - 0 = Exchange Service Parameters only,
  - 1 = Establish image pair and exchange Service Parameters;
- d) **Service Parameters:** No Common Service Parameters are currently specified. The length of the optional Service Parameters may be from 0 to 60 words as specified in the respective FC-4 standard (see 7.1.1). The first three words of each PRLI service parameter page shall be as specified in table 46, words 0 to 2.

#### 4.3.19.4 Reply Sequence

**LS\_RJT:** LS\_RJT signifies rejection of the PRLI Request

**LS\_ACC:** LS\_ACC signifies successful completion of the PRLI Request. The format of the LS\_ACC Payload is shown in table 47.

**Table 47 – PRLI LS\_ACC Payload**

Bits Word	31 .. 24	23 .. 16	15 .. 08	07 .. 00
0	02h	Page Length	Payload Length	
1				
..	Service Parameter Response page			
N				

The LS\_ACC Payload fields are defined as follows:

- a) **Page length:** Byte 1 of word 0 contains an 8-bit value that specifies the length of the Service Parameter Response page. The right-most two bits shall be zeros. The value shall be the same value as in the Page Length field of the PRLI Request;
- b) **Payload length:** Bytes 2-3 of word 0 contain a 16-bit value that specifies the length of the PRLI LS\_ACC Payload. The right-most two bits shall be zeros. The value specified shall be greater than or equal to 16, and less than or equal to 65 532; and
- c) **Service parameter response page:** Words 1:N of the PRLI LS\_ACC Payload contain the Service Parameter Response page. The Service Parameter Response page contains Service Parameter responses for a single image pair or Nx\_Port pair and is associated with a single FC-4 TYPE or common to all FC-4 Types at that image pair or Nx\_Port pair.

The format of PRLI LS\_ACC Service Parameter Response pages is described in table 48.

**Table 48 – PRLI LS\_ACC service parameter response page format**

Item	Word	Bit
TYPE Code or Common Service Parameters	0	31-24
TYPE Code Extension	0	23-16
Obsolete	0	15
Obsolete	0	14
Image Pair Established	0	13
Reserved	0	12
Response Code (see table 49)	0	11-8
Reserved	0	7-0
Obsolete	1	31-0
Obsolete	2	31-0
Service Parameter Response (optional per FC-4)	3 - 63 as specified by each FC-4	31-0

The PRLI LS\_ACC service parameter response page format fields are defined as follows:

- a) **TYPE code or common service parameters:** Identifies the protocol associated with this Service Parameter Response page. If byte 0 of the first word of a Service Parameter Response page contains the value 00h, the Service Parameter page contains Service Parameters common to all FC-4 Types at that image pair or Nx\_Port pair. If byte 0 of the first word of a Service Parameter Response page contains a value other than 00h, the Service Parameter page contains Service Parameters for the FC-4 TYPE indicated;
- b) **TYPE code extension:** Reserved for future use;
- c) **Image Pair Established:** Image Pair Established is valid only if bit 13 was set to one on the corresponding Service Parameter page of the PRLI Request.  
  
 0 = Image pair not established, see response code for additional information,  
 1 = Image pair established;
- d) **Response code:** The response code field contains an encoded binary value indicating the result of the PRLI Request. The meanings of the encoded response code values are shown in table 49; and

- e) **Service parameter response:** Provides feedback to the Originator as to the resultant state of the Service Parameters as returned by the Responder. The length of the PRLI LS\_ACC service parameter response may be 0 to 60 words long as specified in the respective FC-4 standard (see 7.1.1). The first three words of each PRLI LS\_ACC service parameter response page shall be as specified in table 48, words 0 to 2.

**Table 49 – PRLI accept response code**

<b>Encoded Value Word 0, Bits 11-8</b>	<b>Description</b>
0000b	Reserved
0001b	Request executed
0010b	The Exchange recipient has no resources available for establishing image pairs between the specified source and destination Nx_Ports. The PRLI Request may be retried.
0011b	Initialization is not complete for the Exchange recipient. The PRLI Request may be retried.
0100b	Obsolete
0101b	The Exchange recipient has a predefined configuration that precludes establishing this image pair. The PRLI Request shall not be retried.
0110b	Request executed conditionally. Some Service Parameters were not able to be set to their requested state (see table 46)
0111b	Obsolete
1000b	Service Parameters are invalid
1001b to 1111b	Reserved

#### **4.3.20 Process logout (PRLO)**

##### **4.3.20.1 Description**

The PRLO ELS is used to request invalidation of the operating environment between an image at the initiating Nx\_Port and an image at the recipient Nx\_Port. PRLO frees resources committed by a previous PRLI function (see 7.2).

##### **4.3.20.2 Protocol**

- a) Process Logout Request Sequence
- b) LS\_ACC or LS\_RJT Reply Sequence

##### **4.3.20.3 Request Sequence**

**Addressing:** The S\_ID field designates the Nx\_Port requesting Process Logout. The D\_ID field designates the destination Nx\_Port of the Process Logout.

**Payload:** The format of the Payload is shown in table 50.

**Table 50 – PRLO Payload**

Bits Word	31 .. 24	23 .. 16	15 .. 08	07 .. 00
0	PRLO (21h)	Obsolete (10h) <sup>a</sup>	Payload Length	
1	<b>Logout Parameter page</b> (4 words)			
..				
4				
<sup>a</sup> This field is obsolete, but shall be set to 10h for compatibility.				

The PRLO Payload fields shall be defined as follows:

- a) **Payload length:** The Payload length shall be 20; and
- b) **Logout parameter page:** Words 1:4 of the PRLO Payload contain the Logout Parameter page. The Logout Parameter page contains logout parameters for a single image pair and is associated with either a single FC-4 TYPE or is common to all FC-4 TYPE codes for the specified image pair.

The format of PRLO Logout Parameter pages is described in table 51.

**Table 51 – PRLO logout parameter page format**

Item	Word	Bit
TYPE Code or Common Logout Parameters <sup>a</sup>	0	31-24
TYPE Code Extension	0	23-16
Obsolete	0	15
Obsolete	0	14
Reserved	0	13-0
Obsolete	1	31-0
Obsolete	2	31-0
Logout Service Parameters (Optional per FC-4)	3	31-0
<sup>a</sup> If byte 0 of the first word of a Logout Parameter page is set to the value 00h, the Logout Parameter page is common to all FC-4 Types at that image pair.		

The PRLO logout parameter page format fields shall be defined as follows:

- a) **TYPE code or common logout parameters:** Identifies the protocol associated with this Logout Parameter page. If byte 0 of the first word of a Logout Parameter page contains the value

00h, the Logout Parameter page contains Logout Parameters common to all FC-4 Types at that image pair or Nx\_Port pair. If byte 0 of the first word of a Logout Parameter page contains the value other than 00h, the Logout Parameter page contains Logout Parameters for the FC-4 TYPE indicated;

- b) **TYPE code extension:** Reserved for future use; and
- c) Logout Service Parameters: Word 3 of the PRLO Payload contain the Logout Service Parameters. The Logout Service Parameters contain Service Parameters for a single image pair and is associated with either a single FC-4 TYPE or is common to all FC-4 TYPE codes for the specified image pair. No common Logout Service Parameters are currently specified.

**4.3.20.4 Reply sequence**

**LS\_RJT:** LS\_RJT signifies rejection of the PRLO Request

**LS\_ACC:** LS\_ACC signifies successful completion of the PRLO Request

**LS\_ACC Payload:** The format of the LS\_ACC Payload is shown in table 52.

**Table 52 – PRLO LS\_ACC Payload**

Bits Word	31 .. 24	23 .. 16	15 .. 08	07 .. 00
0	02h	Obsolete (10h) <sup>a</sup>	Payload Length	
1	<b>Logout Parameter Response page</b> (4 words)			
..				
N				
<sup>a</sup> This field is obsolete, but shall be set to 10h for compatibility.				

The PRLO LS\_ACC Payload fields shall be defined as follows:

- a) **Payload length:** The Payload length shall be 20; and
- b) **Logout parameter response page:** Words 1:N of the PRLO LS\_ACC Payload contain the Logout Parameter Response page. The Logout Parameter Response page contains a logout parameter response for a single image pair and is associated with a single FC-4 TYPE or common to all FC-4 Types at that image pair or Nx\_Port pair. See table 53.

The format of PRLO LS\_ACC Logout Parameter Response pages is described in table 53.

**Table 53 – PRLO LS\_ACC logout parameter response page format**

Item	Word	Bit
TYPE Code or Common Logout Parameters <sup>a</sup>	0	31-24
TYPE Code Extension	0	23-16
Obsolete	0	15
Obsolete	0	14
Reserved	0	13-12
Response Code (see table 54)	0	11-8
Reserved	0	7-0
Obsolete	1	31-0
Obsolete	2	31-0
Reserved	3	31-0
<sup>a</sup> If byte 0 of the first word of a Logout Parameter page is set to the value 00h, the Logout Parameter page is common to all FC-4 Types at that image pair.		

The PRLO LS\_ACC logout parameter response page format fields shall be defined as follows:

- a) **TYPE code or common logout parameters:** Identifies the protocol associated with this Logout Parameter Response page. If byte 0 of the first word of a Logout Parameter Response page contains the value 00h, the Logout Parameter page contains Logout Parameters common to all FC-4 Types at that image pair or Nx\_Port pair. If byte 0 of the first word of a Logout Parameter Response page contains a value other than 00h, the Logout Parameter page contains Logout Parameters for the FC-4 TYPE indicated;
- b) **TYPE code extension:** Reserved for future use; and



- c) **Response code:** The Response code field contains an encoded binary value indicating the result of the PRLO Request and the status of the image pair. The meanings of the encoded Response code values are shown in table 54.

**Table 54 – PRLO accept response code**

Encoded Value Word 0, Bits 11-8	Description
0000b	Reserved
0001b	Request executed
0010b - 0011b	Reserved
0100b	The Exchange recipient corresponding to the Responder Process_Associator specified in the PRLO Request and PRLO LS_ACC response does not exist. The PRLO Request shall not be retried.
0101b - 0110b	Reserved
0111b	Obsolete
1000b	Obsolete
1001b - 1111b	Reserved

#### 4.3.21 Test Process Login State (TPLS)

##### 4.3.21.1 Description

The TPLS ELS is used to determine whether image pairs are established for the image pairs specified by the combination of the S\_ID || Originator Process\_Associator || D\_ID || Responder Process\_Associator. Upon receiving a TPLS Request, the receiving Nx\_Port checks whether it has an image pair established for each specified image.

TPLS verifies the Login state for the source Nx\_Port at the destination Nx\_Port.

The LS\_ACC Reply Sequence confirms the successful completion of the TPLS function and indicates whether or not an image pair is established for the source specified by the S\_ID and image pair(s) contained in the Payload. The Payload of the LS\_ACC Reply indicates the state of the image pair.

##### 4.3.21.2 Protocol

- a) Test Process Login State Request Sequence
- b) LS\_ACC or LS\_RJT Reply Sequence

##### 4.3.21.3 Request Sequence

**Addressing:** The S\_ID field designates the source Nx\_Port associated with the image pair. The D\_ID field designates the destination Nx\_Port associated with the image pair.

**Payload:** The format of the Payload is shown in table 55.

**Table 55 – TPLS Payload**

Bits Word	31 .. 24	23 .. 16	15 .. 08	07 .. 00
0	TPLS (23h)	Obsolete (10h) <sup>a</sup>	Payload Length	
1	<b>Image Pair ID page</b> (4 words)			
..				
N				
<sup>a</sup> This field is obsolete, but shall be set to 10h for compatibility.				

- a) **Payload length:** The Payload length shall be 20; and
- b) **Image pair ID page:** Words 1:N of the TPLS Payload contain the Image Pair ID pages. The Image Pair ID page contains parameters required to identify a single image pair. The format of Image Pair ID pages is described in table 56.

**Table 56 – TPLS image pair ID page format**

Item	Word	Bit
Reserved	0	31-16
Obsolete	0	15
Obsolete	0	14
Reserved	0	13-0
Obsolete	1	31-0
Obsolete	2	31-0
Reserved	3	31-0

**4.3.21.4 Reply sequence**

**LS\_RJT:** LS\_RJT signifies rejection of the TPLS Request.

**LS\_ACC:** LS\_ACC signifies successful completion of the TPLS Request. The format of the LS\_ACC Payload is shown in table 57.

**Table 57 – TPLS LS\_ACC Payload**

Bits Word	31 .. 24	23 .. 16	15 .. 08	07 .. 00
0	(02h)	Obsolete (10h) <sup>a</sup>	Payload Length	
1	TPLS Response page (4 words)			
..				
N				
<sup>a</sup> This field is obsolete, but shall be set to 10h for compatibility.				

- a) **Payload length:** Bytes 2-3 of word 0 contain a 16-bit value that specifies the length of the TPLS LS\_ACC Payload. The value shall be 20; and
- b) **TPLS response page:** Words 1:N of the TPLS Payload contain the Image Pair ID page. The TPLS Response page contains TPLS response information associated with a single image pair.

The format of TPLS Response pages is described in table 58.

**Table 58 – TPLS response page format**

Item	Word	Bits
Reserved	0	31-16
Obsolete	0	15
Obsolete	0	14
Reserved	0	13-12
Response Code (see table 59)	0	11-8
Reserved	0	7-0
Obsolete	1	31-0
Obsolete	2	31-0
Reserved	3	31-1
Image Pair State	3	0

- a) **Response code:** The Response code field contains an encoded binary value indicating the result of the PRLI Request and the status of the image pair. The meanings of the encoded Response code values are shown in table 59; and

**Table 59 – TPLS accept response code**

Encoded Value Word 0, Bits 11-8	Description
0000b	Reserved
0001b	Request executed
0010b - 0110b	Reserved
0111b	Obsolete
1000b - 1111b	Reserved

- b) **Image pair state:**

1 = image pair established,  
0 = image pair not established.

#### 4.3.22 Request Node Identification Data (RNID)

##### 4.3.22.1 Introduction

The RNID ELS is an ELS for acquiring Node Identification Data. The normal response shall be an Accept (i.e., LS\_ACC) ELS Sequence with Node Identification Data in its payload. If the recipient Nx\_Port or Fx\_Port does not support the RNID ELS, it shall reply with an LS\_RJT ELS Sequence with a reason code of "Command not supported". If the recipient Nx\_Port or Fx\_Port does not support the requested Node Identification Data format, it shall either reply with an LS\_RJT ELS Sequence with a reason code of "Unable to perform command request" and reason code explanation of "Unable to supply requested data" or reply with an LS\_ACC ELS Payload containing only the Common Identification Data.

If an Nx\_Port sends an RNID ELS and receives an LS\_RJT Sequence with a reason code of "Unable to perform command request" and reason code explanation of "Unable to supply requested data", the ULP may cause the Nx\_Port to retry the RNID ELS with a different Node Identification Data Format request if an Nx\_Port sends an RNID ELS and receives a reply with an LS\_ACC ELS containing only Common Identification Data (see Table 65) in its payload, the ULP usage of the Common Identification Data and any further discovery processing is beyond the scope of this standard.

The RNID ELS may be sent to any Nx\_Port. If the RNID ELS is sent to the Fabric Controller (i.e., FFFFDh), then the reply shall represent the Switch that contains the Fx\_Port to which the requesting FC\_Port is attached.

##### 4.3.22.2 Protocol

- a) Request Node-Identification (RNID) request Sequence
- b) LS\_ACC or LS\_RJT Reply Sequence

### 4.3.22.3 Request Sequence

**Addressing:** The S\_ID field designates the requesting source port or the Fabric Controller (FFFFF-Dh). The D\_ID field designates the Nx\_Port or F\_Port Controller receiving the RNID request or the Fabric Controller (FFFFFFDh).

**Payload:** The format of the RNID Payload is shown in table 60.

**Table 60 – RNID Payload**

Bits Word	31 ... 24 Byte 0	23 ... 16 Byte 1	15 ... 08 Byte 2	07 ... 00 Byte 3
0	RNID (78h)	00h	00h	00h
1	Node Identification Data Format	Reserved		

**Node Identification Data Format:** The format of the Node Identification Data field is shown in table 61.

**Table 61 – Node Identification Data Format**

Value	Description
00h	Shall be set if the requesting Nx_Port is requesting Common Identification Data only (see table 65).
01h – DEh	For Specific Identification Data corresponding to a specific ULP (e.g., FC-SB-4), shall be set to the FC-4 TYPE (see FC-FS-3) of that ULP.
DFh	Shall be used if the General Topology Discovery format (see 4.3.22.5) is to be returned in the RNID Accept Payload.
E0h – FFh	Shall be used to indicate that Specific Node Identification Data in a vendor specific format is to be returned.

### 4.3.22.4 Reply Sequence

**LS\_RJT:** Signifies the rejection of the RNID request

**LS\_ACC:** Signifies acceptance of the RNID request and returns Node Identification Data. The format of the Accept Payload is shown in table 62.

**Table 62 – RNID Accept Payload**

Bits Word	31 ... 24 Byte 0	23 ... 16 Byte 1	15 ... 08 Byte 2	07 ... 00 Byte 3
0	02h	00h	00h	00h
1	Node Identification Data Format	Common Identification Data Length (0 or 16)	VN_Port Phy Type	Specific Identification Data Length
2	Common Identification Data			
...	(0 bytes or 16 bytes)			
5	Specific Identification Data (m)			
6	(0 - max bytes)			
...				
m				

- a) **Node Identification Data Format:** The value of the Node Identification Data Format field is shown in table 63;

**Table 63 – Node Identification Data Format**

Value	Description
00h	The RNID Accept Payload only contains the Common Identification Data (see Table 65).
01h – DEh	The RNID Accept Payload may contain the Common Identification Data and shall contain the Specific Identification Data for the ULP that is assigned an FC-4 frame type (see FC-FS-3) equal to the value of the Node Identification Data Format from the RNID Payload (see Table 61).
DFh	The RNID Accept Payload shall contain the Common Identification Data and General Topology Discovery format Specific Identification Data.
E0h – FFh	The RNID Accept Payload may contain the Common Identification Data and shall contain vendor specific Specific Identification Data.

- b) **Common Identification Data Length:** If Common Node Identification Data is included in the RNID Accept payload, the Common Identification Data length shall specify 16 bytes as the size of the Common Identification Data field. If the ULP indicates in the Node Identification Data Format that no (see table 63) Common Node Identification Data is to be included in the RNID Accept payload, the Common Identification Data length shall be set to zero;

- c) **VN\_Port Phy Type:** Word 1 bits 15-14 identify the type of physical interface for the PN\_Port or PF\_Port through which the RNID request was received (see table 64). Bits 8 - 13 of this field are reserved.

**Table 64 – VN\_Port Phy Type**

Encoded Value Word 1, Bits 15 - 14	Description
00b	No Information about Phy Type Provided.
01b	The sending VN_Port uses an FC-FS-3 PN_Port or PF_Port.
10b	The sending VN_Port uses a lossless Ethernet MAC.
11b	Reserved

- d) **Specific Identification Data Length:** The Specific Identification Data Length field indicates the number of bytes in the Specific Identification Data field. The length is determined by the Node Identification Data Format requested for the respective ULP. This value shall be a multiple of 4. The minimum value of this field is zero bytes. The maximum value of this field is 252 bytes;
- e) **Common Identification-Data:** The format of the Common Identification Data field is shown in table 65; and

**Table 65 – Common Identification Data**

Bits Word	31 ... 24 Byte 0	23 ... 16 Byte 1	15 ... 08 Byte 2	07 ... 00 Byte 3
0	MSB		N_Port_Name	
1			(8 bytes) LSB	
2	MSB		Node_Name	
3			(8 bytes) LSB	

- A) **N\_Port\_Name:** The N\_Port\_Name field provides the Name\_Identifier (see FC-FS-3) of the Nx\_Port or Fx\_Port to which the RNID ELS was directed; and
- B) **Node\_Name:** The Node\_Name field provides the Name\_Identifier (see FC-FS-3) of the node associated with the Nx\_Port or Fx\_Port indicated in the N\_Port\_Name field.
- f) **Specific Identification Data:** The format of the Specific Identification Data field shall be dependent on the Node Identification Data Format field (see Table 61). If the value of the Node Identification Data Format field is set to DFh, the format is General Topology Discovery (see 4.3.22.5). For all other values of the Node Identification Data Format field the standard for the related ULP defines the format, fields used, and size of the parameters.

NOTE 3 – The information in the Specific Identification Data should only be used to determine the product identity of a node. The information in the Specific Identification Data should not be used to determine the functional characteristics or the service capabilities of a node.

**4.3.22.5 General Topology Discovery format:**

If the Node Identification Data Format field in the RNID LS\_ACC Payload (see table 63) indicates the General Topology Discovery format (DFh) the RNID LS\_ACC payload shall contain the following:

- a) Node Identification Data Format field set to DFh;
- b) Common Identification-Data length set to 16;
- c) Specific Identification-Data length set to 52;
- d) Common Node Identification Data (see table 65); and
- e) Specific Identification Data (see table 66).

**Table 66 – General Topology Specific Identification Data**

Bits Word	31 ... 24 Byte 0	23 ... 16 Byte 1	15 ... 08 Byte 2	07 ... 00 Byte 3
0	MSB			
...	Vendor Unique (16 bytes)			
3	LSB			
4	Associated Type			
5	Physical Port Number			
6	Number of Attached Devices			
7	Node Management	IP Version	UDP/TCP Port Number	
8	MSB			
...	IP Address (16 bytes)			
11	LSB			
12	Reserved		Vendor Specific	

- a) **Associated Type:** The Associated Type (see table 67) is the type of Fibre Channel functionality associated with the node of the Nx\_Port or Fx\_Port receiving the RNID request (e.g., switch, hub, storage device);
- b) **Physical Port Number:** A vendor unique value that identifies the physical port that has a Fibre Channel link attached;
- c) **Number of Attached Devices:** The number of LCFs attached to the LCF of the Nx\_Port or Fx\_Port receiving the RNID request. The minimum value is one. The maximum value is 126. For any Nx\_Port receiving the RNID, the Number of Attached Devices shall be set to one. For any FL\_Port receiving the RNID, the Number of Attached Devices shall be set to the number of nonzero ALPAs known to that FL\_Port (i.e., the number of loop devices other than the FL\_Port);
- d) **Node Management:** The Node Management field contains the protocol by which a Node Management Entity for the responding node may be accessed (see table 69);



**Table 67 – Associated Type**

<b>Value (hex)</b>	<b>Type</b>
00 00 00 00	Reserved
00 00 00 01	Unknown
00 00 00 02	Other (none of the following)
00 00 00 03	Hub
00 00 00 04	Switch
00 00 00 05	Gateway
00 00 00 06	obsolete
00 00 00 07	obsolete
00 00 00 09	Storage device (i.e., disk drive, CD-ROM drive, tape drive).
00 00 00 0A	Host
00 00 00 0B	Storage subsystem (e.g., raid, library)
00 00 00 0E	Storage Access Device (e.g., Media changer)
00 00 00 11	NAS server
00 00 00 12	Bridge
00 00 00 13	Virtualization device
xx xx xx FF	Multi-function device (see Table 68 for bit values for xx xx xx)
All Others	Reserved

**Table 68 – Multi-function device bit definitions**

<b>Bit position</b>	<b>Function</b>
31	Hub
30	Switch
29	Gateway
28	Storage device
27	Host
26	Storage subsystem
25	Storage access device
24	Wavelength division multiplexer
23	NAS server
22	Bridge
21	Virtualization device
20-8	Reserved

**Table 69 – Node Management**

Value	Protocol	Reference
00h	IP/UDP/SNMP	See RFC 791, RFC 2460, RFC 768, RFC 1157, and RFC 1901
01h	IP/TCP/Telnet	See RFC 791, RFC 2460, RFC 793 and RFC 854
02h	IP/TCP/HTTP	See RFC 791, RFC 2460, RFC 793, and RFC 2616
03h	IP/TCP/HTTPS	See RFC 791, RFC 2460, RFC 793, and RFC 2818
04h	IP/TCP/HTTP/XML	See RFC 791, RFC 2460, RFC 793, RFC 2616, CIM <sup>a</sup> , XML <sup>b</sup> , CIM-XML <sup>c</sup> , and CIM-HTTP <sup>d</sup>
05h - FFh	Reserved	

<sup>a</sup> Distributed Management Task Force, *Common Information Model (CIM) in XML*, Version 2.2, June 14, 1999

<sup>b</sup> World Wide Web consortium, *Extensible Markup Language (XML) 1.0*, Second Edition, October, 6, 2000

<sup>c</sup> Distributed Management Task Force, *Specification for the Representation of CIM in XML (CIM-XML)*, Version 2.0, July 20, 1999

<sup>d</sup> Distributed Management Task Force, *Specification for CIM Operations over HTTP (CIM-HTTP)*, Version 1.0, August 11, 1999

e) **IP Version:** The IP versions are shown in table 70;

**Table 70 – IP Version**

Value	Version	Description
00h	None	Indicates that this port is not providing IP support, and the Node Management, UDP Port, and IP Address fields shall be ignored.
01h	IPv4 (IP version 4)	See RFC 791
02h	IPv6 (IP version 6)	See RFC 2460
03h - FFh	Reserved	

f) **UDP/TCP Port Number:** The numerical value used in UDP (see RFC 768) or TCP (see RFC 793) to distinguish among multiple destinations at the same IP address; and

g) **IP Address:** The IP address by which a Node Management Entity for the responding node may be reached. If the IP version field is set to one, the IPv4 address shall be stored in the least significant word of the IP field and the remainder shall be set to zero.

### 4.3.23 Registered Link Incident Report (RLIR)

#### 4.3.23.1 Description

The following terms are used to reference the ports, nodes, and records related to link incident reporting:

- a) incident port: A port using the LCF on which the link incident occurred and that detected the link incident. More than one VN\_Port associated with a PN\_Port may act as the incident port for link incidents at the PN\_Port;
- b) connected port or connected node: A port or node using the LCF connected directly to the LCF of the incident port by a Fibre Channel link;
- c) reporting port: The port that sends the Link Incident Record;
- d) registered port: A port that is registered with the reporting port to receive link incident reports; and
- e) reporting node: The node that creates the Link Incident Record describing the incident on the incident port.

The RLIR ELS shall provide a method for a reporting Nx\_Port to send a Link Incident Record to a registered Nx\_Port. The normal response to an RLIR ELS Sequence shall be a LS\_ACC ELS Sequence with no Payload. If the recipient Nx\_Port does not support the RLIR ELS, it shall reply with an LS\_RJT ELS Sequence with a reason code of "Command not supported". If the recipient Nx\_Port is unable to accept the specified Link Incident Record type, it shall reply with an LS\_RJT ELS Sequence with a reason code of "Unable to perform command request".

A port shall recognize a link incident if a condition is detected for which an incident code (see table 76) is defined. If a link incident is recognized and a recipient of Link Incident Records is registered for the incident port, a Link Incident Record that contains information related to the link incident shall be created. If a Link Incident Record is generated, the reporting port shall use the link incident reporting procedure to pass the Link Incident Record to a registered port. The link incident reporting mechanism, if any, for a port that does not use this link incident reporting procedure is beyond the scope of this standard.

After a Link Failure is detected, the reporting node may delay recognizing and considering this link failure as a reportable link incident condition, for a specific period of time. Some FC-4 protocols may be capable of transparently recovering from a Link Failure condition, and may not generate a Link Incident Record. If the Link Failure condition persists for longer than the FC-4 specified time out period, then a Link Incident Record is generated and reported.

#### 4.3.23.2 Link Incident reporting procedure

The incident port's reporting node shall generate one Link Incident Record for each link incident. The number of Link Incident Records a reporting node may hold is vendor specific. If the incident port's reporting node attempts to generate a Link Incident Record but does not have resources to hold the record, the oldest Link Incident Record shall be discarded, and the new Link Incident Record shall be retained.

The port selected as the reporting port by the reporting node shall present the Link Incident Records by sending RLIR ELSs to ports registered as valid recipients of Link Incident Records. After sending

all required RLIR ELSs containing the Link Incident Record, the port may discard the Link Incident Record.

The reporting port shall select ports from the registrant list for each Link Incident Record Format. The RLIR shall first be sent to all registered ports that have registered to always receive RLIRs. If no registered ports are registered to always receive RLIR or if RLIR was not successfully transmitted to at least one of those ports registered to always receive RLIRs, then the reporting port shall send the RLIR to a registered port selected from among those that have registered to conditionally receive RLIR. If RLIR is not successfully transmitted to the selected registered port registered to conditionally receive RLIR, the sending port shall select another port, if any, from the established registration list. The RLIR ELS is considered successfully transmitted if a LS\_ACC is received for the RLIR within 2xR\_A\_TOV.

If a reporting port is not able to successfully deliver a RLIR ELS to a registered port, the registered port's registration for the incident port may be discarded. If a reporting node is not able to successfully deliver an RLIR ELS through a particular reporting port, it may select a different reporting port and try again. If no registration is established, it is vendor specific as to whether the incident port's reporting node generates and retains or discards the Link Incident Record.

#### 4.3.23.3 Protocol

- a) RLIR Request Sequence; and
- b) LS\_ACC or LS\_RJT Reply Sequence.

#### 4.3.23.4 Request Sequence

**Addressing:** The S\_ID designates the reporting port that is providing the Link Incident Record. The D\_ID field designates the registered port.

**Payload:** The format of the RLIR Payload is shown in table 71.

**Table 71 – RLIR Payload**

Bits Word	31 .. 24	23 .. 16	15 .. 08	07 .. 00
0	RLIR (79h)	00h	00h	00h
1	Link Incident Record Format	Common Link Incident Record Length	Common Link Incident-Descriptor Length	Specific Link Incident Record Length
2	MSB			LSB
..	Common Link Incident Record (m) (m=4 or 16)			
m+1				
m+2	Common Link Incident Descriptor			
	IQ	IC	Obsolete	
m+3	Specific Link Incident Record (0-max bytes)			
..				
n				

- a) **Link Incident Record Format:** The format of the Link Incident Record-Format field is shown in table 72.

**Table 72 – Link Incident Record Format**

Description	Value
Common Link Incident Record	00h
Specific-coded value	01h - FFh

If the length of the Specific Link Incident Record is zero, the Link Incident Record Format field shall be set to zero. If the length of the Specific Link Incident Record is not zero, the Link Incident Record Format field shall be set to the FC-4 TYPE (see FC-FS-3) associated with the format of the Specific Link Incident Record. A value of zero in the Specific-coded value field indicates that only the Common Link Incident Record and the Common Link Incident Descriptor are being reported and that the Specific Link Incident Record Length shall be zero;

- b) **Common Link Incident Record Length:** If the incident port's Name\_Identifiers (i.e., the N\_Port\_Name and the Node\_Name) only are included in the RLIR ELS Payload, the Common Link Incident Record length shall specify 16 bytes, indicating the size of the Common Link Incident Record field. If the additional Common Link Incident Record fields are included in the Payload, the Common Link Incident Record Length shall specify 64 bytes. The link identified by the N\_Port\_Name and the Node\_Name shall be one end of the link for which the report is being made. The report may be passed through that link or by any other path to the node that has registered to receive RLIR ELSs;
- c) **Common Link Incident Descriptor Length:** The Common Link Incident Descriptor length shall be set to 4h, specifying the number of bytes in the Link Incident Descriptor field;
- d) **Specific Link Incident Record Length:** The Specific Link Incident Record Length shall be specified according to the Link Incident Record Format indicated for the respective ULP. The length shall specify the number of bytes in the Specific Link Incident Record field. This value shall be a multiple of 4. The minimum value of this field is 0. The maximum value of this field is 252;
- e) **Common Link Incident Record:** If the Common Link Incident Length field value is 16 (i.e., m=4), then the Common Link Incident Record shall contain only the first four words (i.e., the Incident port N\_Port\_Name and Incident port Node Name fields) in table 73. If the Common Link Incident Length field value is 64 (i.e., m=16), then the Common Link Incident Record shall contain all the words specified in table 73. Optional fields (i.e., words 4 through 15) that have unknown values shall be set to zero. The Common Link Incident Record format is specified in table 73;

**Table 73 – Common Link Incident Record Data**

Bits Word	31 .. 24	23 .. 16	15 .. 08	07 .. 00
0	MSB _____ Incident port N_Port_Name _____			
1				LSB
2	MSB _____ Incident port Node_Name _____			
3				LSB
4	Incident Port Type	Obsolete		
5	MSB _____ Connected port N_Port_Name _____			
6				LSB
7	MSB _____ Connected port Node_Name _____			
8				LSB
9	MSB _____ Fabric_Name _____			
10				LSB
11	Incident Port Number			
12	Transaction ID			
13	reserved			Time Stamp Format
14	MSB _____ Time Stamp _____			
15				LSB

- A) **Incident port N\_Port Name:** The Name\_Identifier that is the incident port's N\_Port\_Name;
- B) **Incident port Node\_Name:** The Name\_Identifier that is the incident port's Node\_Name;
- C) **Incident Port Type:** The value in the Incident Port Type field specifies the type of the incident port. Port Type values are defined in FC-GS-3. A value of zero in the field indicates the Incident Port Type is unknown or unspecified;
- D) **Connected port N\_Port\_Name:** The Name\_Identifier that is the connected port's N\_Port\_Name;
  - aa) If the incident port is an L\_Port in a private loop, the connected port shall be the port associated with the link incident, if known;
  - bb) If the incident port is an L\_Port in a public loop, the connected port shall be the FL\_Port;
  - cc) If the incident port is an Nx\_Port connected to a Fabric, the connected port shall be the F\_Port;
  - dd) If the incident port is an FL\_Port, the connected port shall be the port associated with the link incident, if known; and
  - ee) If the connected port's N\_Port\_Name is unknown or unspecified, the Connected Port N\_Port\_Name may be zero.

- E) **Connected Port Node\_Name:** The Name\_Identifier that is the Node\_Name of the port described by the Connected Port N\_Port\_Name. If the connected port is an Fx\_Port, the Node\_Name may be the Fabric\_Name, the Node\_Name of the local Fabric element, or unspecified. If the Node\_Name is unknown or unspecified, the corresponding field shall be zero;
- F) **Fabric\_Name:** The Fabric\_Name of the incident port's Fabric. For Nx\_Port devices this is the value obtained in the FLOGI LS\_ACC Payload. Private loop devices do not have a Fabric\_Name and shall report zeros;
- G) **Incident Port Number:** The vendor specific identification of the LCF on which the link incident occurred within the unit having Fibre Channel ports. If this field is presented in the Common Link Incident Record, the Incident Port Number shall be valid;
- H) **Transaction ID:** A 32-bit value that starts at one and is incremented by one for each link incident record generated by the reporting node. Applications receiving link incident records may use this value to eliminate duplicates or detect missing records. The value of zero shall be used only to indicate that the Transaction ID is unknown or unspecified;
- I) **Time Stamp Format:** This field specifies the format of the Time Stamp field as shown in table 74; and
- J) **Time Stamp:** The time stamp value in the format specified by the Time Stamp Format field. If the Time Stamp Format value is 0, the Time Stamp field is unknown or unspecified and may have any value.

**Table 74 – Time Stamp Format values**

Value	Meaning
00h	The Time Stamp field is unknown or unspecified.
01h	Time Server: The 64 bit time stamp is reported in units of seconds and fractions of a second. The time stamp uses the value obtained from the Time Server (see FC-GS-4).
02h	Clock synchronization format: The 64-bit time stamp is reported as defined for the Clock Synchronization Update (CSU) ELS.
03h to FFh	reserved

f) **Common Link Incident Descriptor:**

- A) **Incident Qualifier (IQ):** This field (byte 0 of the Common Link Incident Descriptor) qualifies the manner in which the contents of the Link Incident Record shall be interpreted. The meaning is defined in table 75;

**Table 75 – Incident Qualifier**

Bits	Meaning
31	Reserved.



**Table 75 – Incident Qualifier(Continued)**

Bits	Meaning										
30	Reserved.										
29	Switch: If set to one, indicates that the incident port is a port on a switch. If set to zero, indicates that the incident port is not a port on a switch.										
28	Expansion Port: If set to one, indicates that the switch port is an Inter-Switch-Link Expansion port (E_Port). If zero, bit 28 indicates that the switch port is not an Inter-Switch-Link Expansion port.										
27-26	Severity Indication: Bits 27-26 constitute a two-bit code that identifies the severity indication for the link incident. The codes and their meanings are as follows:										
	<table border="1"> <thead> <tr> <th data-bbox="423 722 509 772">Code</th> <th data-bbox="509 722 1421 772">Meaning</th> </tr> </thead> <tbody> <tr> <td data-bbox="423 772 509 863">0</td> <td data-bbox="509 772 1421 863">Informational report: Indicates link incident notification of an informational purpose.</td> </tr> <tr> <td data-bbox="423 863 509 982">1</td> <td data-bbox="509 863 1421 982">Link degraded but operational: Indicates if the link associated with the incident port is not in a Link-Failure or Offline State as a result of the event that generated the Link Incident Record.</td> </tr> <tr> <td data-bbox="423 982 509 1102">2</td> <td data-bbox="509 982 1421 1102">Link not operational: Indicates if the link associated with the incident port is in a Link-Failure or Offline State as a result of the event that generated the Link Incident Record.</td> </tr> <tr> <td data-bbox="423 1102 509 1163">3</td> <td data-bbox="509 1102 1421 1163">Reserved.</td> </tr> </tbody> </table>	Code	Meaning	0	Informational report: Indicates link incident notification of an informational purpose.	1	Link degraded but operational: Indicates if the link associated with the incident port is not in a Link-Failure or Offline State as a result of the event that generated the Link Incident Record.	2	Link not operational: Indicates if the link associated with the incident port is in a Link-Failure or Offline State as a result of the event that generated the Link Incident Record.	3	Reserved.
	Code	Meaning									
	0	Informational report: Indicates link incident notification of an informational purpose.									
	1	Link degraded but operational: Indicates if the link associated with the incident port is not in a Link-Failure or Offline State as a result of the event that generated the Link Incident Record.									
2	Link not operational: Indicates if the link associated with the incident port is in a Link-Failure or Offline State as a result of the event that generated the Link Incident Record.										
3	Reserved.										
0	Informational report: Indicates link incident notification of an informational purpose.										
1	Link degraded but operational: Indicates if the link associated with the incident port is not in a Link-Failure or Offline State as a result of the event that generated the Link Incident Record.										
2	Link not operational: Indicates if the link associated with the incident port is in a Link-Failure or Offline State as a result of the event that generated the Link Incident Record.										
3	Reserved.										
25	Subassembly type: If set to one, specifies that the type of subassembly used for the port that is the subject of this Link Incident Record is a laser. If set to zero, specifies that the type of subassembly used for the port that is the subject of this Link Incident Record is not a laser.										
24	FRU identification: If set to one, specifies that the Specific-Link Incident Record Data is in a format that provides field-replaceable-unit (FRU) identification. If set to zero, specifies that the Specific-Link Incident Record Data is not in a format that provides field-replaceable-unit (FRU) identification.										

- B) Incident Code (IC): This field (byte 1 of the Common Link Incident Descriptor) contains the incident code that describes the incident that was observed by the incident node; and
  - aa) Bit 23 is reserved; and
  - bb) Bits 22-16 is the value that specifies the type of incident that was observed. The values specified and their meanings are shown in table 76.

**Table 76 – Incident Code values**

<b>Value</b>	<b>Meaning</b>
00h	Reserved.
01h	Implicit incident: A condition, caused by an event known to have occurred within the LCF of the incident port, has been recognized by the incident port. The condition affects the attached link in such a way that it may cause a link incident to be recognized by the LCF of the connected port.
02h	Bit-error-rate threshold exceeded: The LCF of the incident port has detected that the Error Interval Count equals the Error Threshold (see FC-FS-3).
03h	Link Failure - Loss-of-Signal or synchronization: The LCF of the incident port has recognized a Loss-of-Synchronization condition, and it persisted for more than the R_T_TOV timeout period (see FC-FS-3).
04h	Link Failure - NOS recognized: The NOS has been recognized by the LCF of the incident port (see FC-FS-3)
05h	Link Failure - Primitive Sequence timeout: The LCF of the incident port has recognized either a Link-Reset-Protocol timeout (see FC-FS-3), or a timeout when timing for the appropriate response while in the LF1 State and after NOS is no longer recognized (see FC-FS-3).
06h	Link Failure - Invalid Primitive Sequence for port state: The LCF of the incident port recognized either a LR or LRR Primitive Sequence while in the OL3 State (see FC-FS-3).
07h	Link Failure - Loop Initialization time out: The LCF of the incident port failed to complete loop initialization within the normal loop time out period (see FC-AL-2).
08h	Link Failure – receiving LIP(F8): The LCF of the incident port is receiving LIP(F8) indicating some other LCF on the loop is experiencing a Loss-of-Signal condition.
09h - FFh	Reserved.

- C) **Specific Link Incident Record:** The format of the Specific Link Incident Record Field is dependent on the Link Incident Record Format. Specific Link Incident Record formats are defined in the specification for the specific FC-4 (e.g., FC-SB-4) indicated by the Link Incident Record Format.

#### 4.3.23.5 Reply Sequence

**LS\_RJT:** LS\_RJT signifies the rejection of the RLIR Request

**LS\_ACC:** LS\_ACC signifies acceptance of the RLIR Request and its Link Incident Record. The format of the LS\_ACC Payload is shown in table 77.

**Table 77 – RLIR LS\_ACC Payload**

Bits Word	31 .. 24	23 .. 16	15 .. 08	07 .. 00
0	02h	00h	00h	00h

#### 4.3.24 Link Incident Record Registration (LIRR)

##### 4.3.24.1 Description

See 4.3.23.1 for terms related to link incident reporting.

The LIRR ELS requests the recipient to add or remove this source Nx\_Port to or from the list of Nx\_Ports registered to receive the Registered Link Incident Report (RLIR) ELS. The normal response to a LIRR ELS Sequence shall be a LS\_ACC ELS Sequence with no Payload. If the recipient Nx\_Port does not support the LIRR ELS, it shall reply with a LS\_RJT ELS Sequence with a reason code of "Command not supported". If the recipient Nx\_Port is unable to perform the requested LIRR registration function or the specified format is not supported, it shall reply with a LS\_RJT ELS Sequence with a reason code of "Unable to perform command request".

If an Nx\_Port is registering or de-registering with the Fabric for receipt of Link Incident Records from the Fabric, the LIRR ELS shall be sent to the Management Server (FFFFFFAh).

##### 4.3.24.2 Registration for Link Incident Records

To obtain and process Link Incident Records, a ULP shall register its port with other ports of interest. The term "ports of interest" refers to all ports that the registered port may address and for which the port requires their Link Incident Records.

An Nx\_Port shall attempt to register as a valid recipient of subsequent Link Incident Records by sending a LIRR ELS as soon as the requesting Nx\_Port has determined its address identifier and has determined the address identifiers for the ports of interest. The ULP shall indicate the format of Link Incident Records of interest that are being registered. The recipient Nx\_Port shall respond with a LS\_ACC ELS with no Payload.

If a registered ULP is no longer interested in receiving Link Incident Records from any port or ports of interest, it shall send a LIRR ELS to de-register their port as a valid recipient of Link Incident Records. The ULP shall indicate the format of Link Incident Records that are being de-registered.

If a LIRR ELS requesting a de-registration function for a port that is not registered is received, the recipient port accepts the request by sending a LS\_ACC ELS and performs no further action. If a LIRR ELS requesting a registration for a port that is already registered for the specified format, the recipient port shall accept by sending a LS\_ACC ELS request and perform no further action.

The recipient of a LIRR ELS shall maintain a separate established registration list of valid Link Incident Record recipients for each registration format specified. The size of the established registration list maintained by each port for each specified format is vendor specific. If the established registration list is full for an add registration function request, the port shall reply with a LS\_RJT ELS Sequence with a reason code of "Unable to perform command request".

A Logout occurring between a reporting port and a registered port shall cause de-registration of the valid-recipient port in the established registration list maintained by the port.

**4.3.24.3 Responsibilities of Valid-Registered Recipients**

A valid-registered recipient shall be capable of receiving and processing Link Incident Records that are generated according to the Link Incident reporting procedure (see 4.3.23.2). The usage and coordination of Link Incident Records by ULPs is beyond the scope of this standard.

If a valid registered recipient receives a Link Incident Record for a format that does not match its registration format, the recipient port shall reject the RLIR ELS with a reason code of “Unable to perform command request”.

**4.3.24.4 Protocol**

- a) LIRR Request Sequence; and
- b) LS\_ACC or LS\_RJT Reply Sequence.

**4.3.24.5 Request Sequence**

**Addressing:** The S\_ID designates the source port requesting registration for Link Incident Records. The D\_ID field designates the port receiving the registration request.

**Payload:** The format of the LIRR Payload is shown in table 78.

**Table 78 – LIRR Payload**

Bits Word	31 .. 24	23 .. 16	15 .. 08	07 .. 00
0	LIRR (7Ah)	00h	00h	00h
1	Registration Function	Link Incident Record-Registration Format	Reserved	

The LIRR Payload field shall be defined as follows:

- a) **Registration Function:** The Registration function shall specify the mode of registration (e.g., whether the recipient node adds or removes the sending Nx\_Port to or from its list of registered

nodes, hereafter referred to as the established registration list). The format of the Registration Function field is shown in table 79; and

**Table 79 – Registration Function**

value	Function
00h	Reserved
01h	Set registration – conditionally receive: The source port is registered as a valid recipient of subsequent RLIR ELSs for the format specified. The port is added to the appropriate format specific established registration list. This source port is chosen as the recipient of a link incident record only if no other recipients from this established registration list have been chosen.
02h	Set registration – always receive: The source port is registered as a valid recipient of subsequent RLIR ELSs for the format specified. The port is added to the appropriate format specific established registration list. This source port is always chosen as a recipient of a link incident record.
03h - FEh	Reserved
FFh	Clear registration: The source port is de-registered as a valid recipient of subsequent RLIR ELSs for the format specified (i.e., remove from the established registration list).

- b) **Link Incident Record-Registration Type:** The type of the requested Link Incident Record Registration is shown in table 80.

**Table 80 – Link Incident Record-Registration Format**

Value	Description
00h	Common Format
01h - FFh	Specific-coded value

A Link Incident Record Registration Format of 00h specifies that only the Common Link Incident Record and the Link Incident Descriptor is reported. If the Link Incident Record Registration format is non-zero, it shall be set to the Specific-coded value (FC-4 Device Type) of the registration format being requested for a specific client ULP (e.g., see FC-SB-4). The Specific-coded value uses the TYPE codes defined in FC-4 data structures of this standard. These codes allow clients to define and register for Link Incident Record formats for their own particular usage according to the unique FC-4 protocol.

**4.3.24.6 Reply Sequence**

**LS\_RJT:** LS\_RJT signifies the rejection of the LIRR Request

**LS\_ACC:** LS\_ACC Signifies acceptance of the LIRR Request and the registration for RLIR ELSs. The format of the LS\_ACC Payload is shown in table 81.

**Table 81 – LIRR LS\_ACC Payload**

Bits Word	31 .. 24	23 .. 16	15 .. 08	07 .. 00
0	02h	00h	00h	00h

#### 4.3.25 Discover N\_Port/Service Parameters (PDISC)

##### 4.3.25.1 Description

The PDISC ELS shall transfer Service Parameters from the initiating Nx\_Port to the Nx\_Port associated with the D\_ID without affecting the operating environment between the two ports. This provides the means for exchange of Service Parameters without terminating open Sequences or open Exchanges.

##### 4.3.25.2 Protocol

- a) PDISC Sequence
- b) LS\_ACC or LS\_RJT Reply Sequence

##### 4.3.25.3 Request Sequence

The Payload in PDISC and the LS\_ACC are, except for the ELS\_Command, identical to the Payloads in PLOGI (see 4.3.7) and the corresponding LS\_ACC (see 4.4.2). The interchange of PDISC information shall not modify the operating environment or Service Parameters between the two ports. Service Parameters contained in PDISC shall be ignored and no error condition shall be reported.

##### 4.3.25.4 Reply Sequence

A response shall not be sent to a PDISC if a LR or loop initialization occurs before the LS\_ACC is sent. An LS\_ACC for a PDISC shall be ignored if a LR or loop initialization occurred between the PDISC and the LS\_ACC.

#### 4.3.26 Discover F\_Port Service Parameters (FDISC)

##### 4.3.26.1 Description

The FDISC ELS shall transfer Service Parameters from the initiating Nx\_Port to the Fx\_Port at well-known F\_Port\_ID (i.e., FFFFFFFh). This provides the means for the exchange of Service Parameters and the assignment of additional N\_Port\_IDs without changing service parameters.

##### 4.3.26.2 Protocol

- a) FDISC Sequence
- b) LS\_ACC, LS\_RJT Reply Sequence

#### 4.3.26.3 Request Sequence

The Payload in FDISC and the corresponding LS\_ACC are, except for the ELS\_Command, identical to the Payloads in FLOGI (see 4.3.7) and the LS\_ACC (see 4.4.2). If the S\_ID of the FDISC ELS is equal to zero, the FDISC ELS shall transfer an N\_Port\_Name and Node\_Name, and request the assignment and Login of an additional N\_Port\_ID (see 6.3). The FDISC ELS with an S\_ID equal to zero shall only be sent by a PN\_Port with at least one N\_Port\_ID that is currently logged in with the Fabric, and the assignment of an additional N\_Port\_ID shall not modify the Service Parameters between the two FC\_Ports.

If the S\_ID of the FDISC ELS is set to a previously-assigned N\_Port\_ID, the FDISC ELS shall contain the N\_Port\_Name and Node\_Name corresponding to that N\_Port\_ID. The interchange of FDISC information shall not modify the operating environment or Service Parameters between the two FC\_Ports. Service Parameters contained in FDISC shall be ignored and no error condition shall be reported.

If the Originator of a FDISC with S\_ID equal to zero detects a time out, the FDISC may be retried in a different Exchange without aborting the previous Exchange with ABTS-LS.

#### 4.3.26.4 Reply Sequence

If the S\_ID of the FDISC ELS is zero, the D\_ID field of the LS\_ACC shall be set to the additional N\_Port\_ID being assigned. After the F\_Port Controller sends the LS\_ACC, it shall consider Fabric Login to have occurred for the Nx\_Port to which the additional N\_Port\_ID was assigned.

If the S\_ID of the FDISC ELS is not zero and is currently logged in, the D\_ID of the LS\_ACC shall be set to the S\_ID of the FDISC ELS.

If an FDISC ELS with an S\_ID set to zero is received by a F\_Port Controller and no N\_Port\_ID is logged in, or if the S\_ID is set to a non-zero N\_Port\_ID that is not currently logged, then an F\_RJT with the reason code set to 'Login required' shall be returned to the S\_ID of the FDISC ELS if it was issued in Class 2, and the FDISC ELS shall be discarded if it was issued in Class 3.

#### 4.3.27 Discover Address (ADISC)

##### 4.3.27.1 Description

The ADISC ELS shall exchange addresses and identifiers of communicating Nx\_Ports.

##### 4.3.27.2 Protocol

- a) ADISC Sequence; and
- b) LS\_ACC or LS\_RJT Reply Sequence.

### 4.3.27.3 Request Sequence

The ADISC Request payload format is shown in table 82.

**Table 82 – ADISC Request payload**

Bits Word	31 .. 24	23 .. 16	15 .. 08	07 .. 00
0	ADISC (52h)	00h	00h	00h
1	Reserved	Hard Address of Originator		
2	MSB	N_Port_Name of Originator		LSB
3		(8 bytes)		
4	MSB	Node_Name of Originator		LSB
5		(8 bytes)		
6	Reserved	N_Port_ID of Originator		

- a) **Hard Address of Originator:** A 24-bit L\_Port\_ID that consists of:
- A) the 8-bit Domain address in the most significant byte;
  - B) the 8-bit Area address in the next most significant byte; and
  - C) the 8-bit AL\_PA that an L\_Port attempts to acquire in the LIHA sequence during loop initialization in the least significant byte (see FC-AL-2).

If an L\_Port does not have a hard address, or if a port does not have FC-AL-2 capability, it shall report zeroes in this field.

- b) **N\_Port\_Name of Originator:** The 8-byte N\_Port\_Name of the Originator;
- c) **Node\_Name of Originator:** The 8-byte Node\_Name of the Originator; and
- d) **N\_Port\_ID of Originator:** The 24-bit S\_ID used in the header of the ADISC Request frame.



**4.3.27.4 Reply Sequence**

The LS\_ACC Payload format is shown in table 83.

**Table 83 – ADISC LS\_ACC Payload**

Bits Word	31 .. 24	23 .. 16	15 .. 08	07 .. 00
0	02h	00h	00h	00h
1	Reserved	Hard Address of Responder		
2	MSB N_Port_Name of Responder			LSB
3	(8 bytes)			
4	MSB Node_Name of Responder			LSB
5	(8 bytes)			
6	Reserved	N_Port_ID of Responder		

- a) **Hard Address:** A 24-bit L\_Port\_ID that consists of:
  - A) the 8-bit Domain address in the most significant byte;
  - B) the 8-bit Area address in the next most significant byte; and
  - C) the 8-bit AL\_PA that an L\_Port attempts to acquire in the LIHA sequence during loop initialization in the least significant byte (see FC-AL-2).

If an L\_Port does not have a hard address, or if a port does not have FC-AL-2 capability, it shall report zeroes in this field.

- b) **N\_Port\_Name of Responder:** The 8-byte N\_Port\_Name of the Responder;
- c) **Node\_Name of Responder:** The 8-byte Node\_Name of the Responder; and
- d) **N\_Port\_ID of Responder:** The 24-bit S\_ID used in the header of the ADISC LS\_ACC frame.

A response shall not be sent to an ADISC if an LR or loop initialization occurs before the LS\_ACC is sent. An LS\_ACC for a ADISC shall be ignored if an LR or loop initialization occurred between the ADISC and the LS\_ACC.

Table 84 summarizes the responses to FDISC, PDISC and ADISC.

**Table 84 – Response summary to FDISC/PDISC**

ELS command	Responding Port Status	Responding Nx_Port	Responding F_Port Controller	
		Class 2, or 3	Class 2	Class 3
FDISC	Logged in	LS_RJT <sup>c</sup>	LS_ACC	LS_ACC
	Not Logged in	LS_RJT <sup>c</sup>	F_RJT <sup>b</sup>	Discard
PDISC	Logged in	LS_ACC	LS_RJT <sup>c</sup>	Discard
	Not Logged in	LS_RJT <sup>a</sup>	F_RJT <sup>b</sup>	Discard
ADISC	Logged in	LS_ACC	LS_RJT <sup>c</sup>	Discard
	Not Logged in	LS_RJT <sup>a</sup>	F_RJT <sup>b</sup>	Discard

<sup>a</sup> A LOGO ELS sequence or an LS\_RJT ELS Sequence with the reason code set to “Unable to perform command request” and the reason code explanation set to “N\_Port Login required” shall be returned.

<sup>b</sup> An F\_RJT with the Reject reason code set to “Login required” shall be returned.

<sup>c</sup> A LOGO ELS Sequence or an LS\_RJT ELS Sequence with the reason code set to “Command not supported” and the reason code explanation set to “Request not supported” shall be returned.

**4.3.28 Third Party Process Logout (TPRLO)**

**4.3.28.1 Description**

The TPRLO ELS is used to invalidate the operating environments (i.e., remove image pairs and associated resources) at the recipient Nx\_Port for the specified TYPE.

TPRLO has the same effect on the recipient Nx\_Port as if all Nx\_Ports that have performed Process Login with the recipient Nx\_Port for the specified TYPE, performed PRLO with the recipient Nx\_Port.

**4.3.28.2 Protocol**

- a) TPRLO Request Sequence; and
- b) LS\_ACC or LS\_RJT Reply Sequence.

**4.3.28.3 Request Sequence**

**Addressing:** The S\_ID field designates the Nx\_Port initiating TPRLO. The D\_ID field designates the destination Nx\_Port of the TPRLO.

**Payload:** The TPRLO format is shown in table 85.

**Table 85 – TPRLO Payload**

Bits Word	31 .. 24	23 .. 16	15 .. 08	07 .. 00
0	TPRLO (24h)	Obsolete (10h) <sup>a</sup>	Payload Length	
1	Logout Parameter page (4 words)			
..				
n				
<sup>a</sup> This field is obsolete, but shall be set to 10h for compatibility.				

- a) **Payload length:** The payload length shall be 20; and
- b) **Logout parameter page:** Words 1:N of the TPRLO Payload contain the Logout Parameter page. The Logout Parameter page contains logout parameters for a single image pair and is associated with either a single FC-4 TYPE or is common to all FC-4 TYPE codes for the specified image pair.

The TPRLO Logout parameter page is shown in table 86.

**Table 86 – TPRLO logout parameter page**

Item	Word	Bit
TYPE Code or Common Service Parameters	0	31-24
TYPE Code Extension	0	23-16
Third Party Originator Process_Associator Validity - obsolete	0	15
Responder Process_Associator Validity - obsolete	0	14
Third Party Originator N_Port_ID Validity - obsolete	0	13
Global Process Logout	0	12
Reserved	0	11-0
Third Party Originator Process_Associator - obsolete	1	31-0
Responder Process_Associator - obsolete	2	31-0
Reserved	3	31-24
Third Party Originator N_Port_ID - obsolete	3	23-0

- a) **TYPE Code or Common Logout Parameters:** Identifies the protocol associated with this TPRLO Logout Parameter page. If byte 0 of the first word of a TPRLO Logout Parameter page contains the value 00h, the TPRLO Logout Parameter page contains logout parameters com-

mon to all FC-4 Types at that image pair or Nx\_Port pair. If byte 0 of the first word of a TPRLO Logout Parameter page contains the value other than 00h, the TPRLO Logout Parameter page contains logout parameters for the FC-4 TYPE indicated; and

- b) **TYPE code extension:** Reserved for future use;
- c) **Global Process Logout:** The Global Process Logout bit shall be set to one, and specifies:
  - A) only the TYPE code and TYPE code extension fields shall have meaning, along with the Global Process Logout bit itself;
  - B) all image pairs for all Nx\_Ports with which Process Login has been performed shall be removed from the recipient Nx\_Port for the specified TYPE; and
  - C) all resources associated with the establishment of all image pairs of the specified TYPE at the recipient Nx\_Port shall be released.

The TPRLO LS\_ACC Payload format is shown table 87.

**Table 87 – TPRLO LS\_ACC Payload**

Bits Word	31 .. 24	23 .. 16	15 .. 08	07 .. 00
0	02h	Obsolete (10h) <sup>a</sup>	Payload Length	
1	Logout Parameter page (4 words)			
..				
n				
<sup>a</sup> This field is obsolete, but shall be set to 10h for compatibility.				

- a) **Payload Length:** The Payload Length field specifies the length of the TPRLO LS\_ACC payload. The Payload Length value shall be 20; and
- b) **Logout Parameter page:** The TPRLO LS\_ACC Logout Parameter page format is the same as the TPRLO Request Logout Parameter page format (see table 86) and the field values shall be set to the values received in the TPRLO Request Logout Parameter page.

**4.3.29 Clock Synchronization Request (CSR)**

**4.3.29.1 Description**

The CSR ELS is used to request the Clock Synchronization Server to either send or to quit sending periodic Clock Synchronization Update (CSU) ELS frames or Clock Synchronization primitives, depending on the method implemented (see FC-FS-3).

**4.3.29.2 Protocol**

- a) Clock Synchronization Request Sequence; and
- b) LS\_ACC or LS\_RJT Reply Sequence.

### 4.3.29.3 Request Sequence

**Addressing:** The S\_ID field designates the source Nx\_Port requesting Clock Synchronization updates. The D\_ID field designates either the Clock Synchronization Server (FFFFFF6h) or the Fabric Controller (FFFFFFDh).

**Payload:** The format of the Payload is shown in table 88.

**Table 88 – CSR Payload**

Bits Word	31 .. 24	23 .. 16	15 .. 08	07 .. 00
0	CSR (68h)	00h	00h	00h
1	Clock Sync Mode	CS_Accuracy	CS_Implemented_M SB	CS_Implemented_L SB
3	CS_Update_Period			

- a) **Clock Sync Mode:** The meaning of the Clock Sync Mode byte in the CSR Payload is defined in table 89;

**Table 89 – CSR Clock Sync Mode Meaning**

Value	S_ID set to the Clock Sync Server	S_ID set to the Fabric Controller
00h	Enable Clock Synchronization service to this client. The CS_Accuracy, CS_Implemented_MSB, CS_Implemented_LSB, and CS_Update_Period fields are not meaningful in the CSR Request.	Return Quality of Service parameters. The CS_Accuracy, CS_Implemented_MSB, CS_Implemented_LSB, and CS_Update_Period fields are not meaningful in the CSR Request.
01h	Enable Clock Synchronization service to this client. The CS_Accuracy, CS_Implemented_MSB, CS_Implemented_LSB, and CS_Update_Period fields contain the requested Quality of Service parameters.	Return Quality of Service parameters. The CS_Accuracy, CS_Implemented_MSB, CS_Implemented_LSB, and CS_Update_Period fields contain the requested Quality of Service parameters.
02h – FEh	Reserved	Reserved
FFh	Disable Clock Synchronization service to this client	Reserved

- b) **CS\_Accuracy (Mantissa and Exponent):** This field contains the CS\_Accuracy\_Mantissa (Bits 23-21) and CS\_Accuracy\_Exponent (Bits 20-16). These bits indicate the requested accuracy of the Clock Synchronization value as it leaves the server port. Specifically, the request is that the Clock Count value is always within the range of:

$$T_{\text{reference}} \pm (0.5 + \text{CS\_Accuracy\_Mantissa} * 2^{-4}) * 2^{(\text{CS\_Accuracy\_Exponent}-30)},$$

where

- A) T\_reference is the clock reference value internal to the server;
- B) CS\_Accuracy\_Mantissa is a value from 000b to 111b; and
- C) CS\_Accuracy\_Exponent is a value from 00000b to 11111b;

Example #1, if CS\_Accuracy Mantissa and Exponent = 001b and 01011b, respectively, the Clock Synchronization value as it exits the server is requested to be within the range of:

$$T\_reference \pm 1.073 \mu\text{sec}$$

Example #2, if CS\_Accuracy Mantissa and Exponent = 111b and 11000b, respectively, the Clock Synchronization value as it exits the server is requested to be within the range of:

$$T\_reference \pm 14.65 \text{ msec}$$

- c) **CS\_Implemented\_MSB:** This field is a value that is constrained to the range of 0 to 63. These bits indicate the requested most significant bit position within the 64-bit Clock Count field (e.g., a value of '110111b' indicates that the client requests that the highest bit that contains meaningful information be the MSB of byte 1 of the Clock Count field);
- d) **CS\_Implemented\_LSB:** This field is a value that is constrained to the range of 0 to 63. These bits indicate the requested least significant bit position within the 64-bit Clock Count field (e.g., a value of 001000b indicates that the client requests that the lowest bit that contains meaningful information be the LSB of byte 6 of the Clock Count field); and
- e) **CS\_Update\_Period:** This field is a value. It represents the requested time, in microseconds, between consecutive updates from the Clock Synchronization server.

#### 4.3.29.4 Reply Sequence

**LS\_RJT:** LS\_RJT signifies rejection of the CSR command.

**LS\_ACC:** LS\_ACC signifies that the Clock Synchronization Server agrees to perform the action requested in the CSR Payload. The format of the LS\_ACC Payload is shown in table 90. The Clock Sync Mode item in the CSR LS\_ACC Payload shall contain the value that was received in the Clock Sync Mode item of the CSR Payload.

**Table 90 – CSR LS\_ACC Payload**

Bits Word	31 .. 24	23 .. 16	15 .. 08	07 .. 00
0	02h	00h	00h	00h
1	Clock Sync Mode	CS_Accuracy	CS_Implemented_MSB	CS_Implemented_LSB
2	CS_Update_Period			

- a) **Clock Sync Mode:** The meaning of the Clock Sync Mode byte in the CSR Payload is defined in table 91;

**Table 91 – CSU Clock Sync Mode Meaning**

Hex Value	Meaning
00h	Clock synchronization service enabled to this client
01h - FEh	Reserved
FFh	Clock synchronization service disabled to this client

- b) **CS\_Accuracy (Mantissa and Exponent):** This field consists of two values, CS\_Accuracy\_Mantissa (Bits 23-21) and CS\_Accuracy\_Exponent (Bits 20-16). These bits indicate the accuracy of the Clock Synchronization value as it leaves the server port. Specifically, the server shall supply a CS\_Accuracy value such that the Clock Count value is always within the range of:

$$T_{\text{reference}} \pm (0.5 + \text{CS\_Accuracy\_Mantissa} * 2^{-4}) * 2^{(\text{CS\_Accuracy\_Exponent}-30)},$$

where

- A)  $T_{\text{reference}}$  is the clock reference value internal to the server;
- B) CS\_Accuracy\_Mantissa is a value from 000b to 111b; and
- C) CS\_Accuracy\_Exponent is a value from 00000b to 11111b;

Example #1, if CS\_Accuracy Mantissa and Exponent = 001b and 01011b, respectively, the Clock Synchronization value as it exits the server shall always be within the range of:

$$T_{\text{reference}} \pm 1.073 \mu\text{sec}$$

Example #2, if CS\_Accuracy Mantissa and Exponent = 111b and 11000b, respectively, the Clock Synchronization value as it exits the server shall always be within the range of:

$$T_{\text{reference}} \pm 14.65 \text{ msec}$$

- c) **CS\_Implemented\_MSB:** This field is a value that is constrained to the range of 0 to 63. It represents the most significant bit position within the Clock Count field that shall contain meaningful information (e.g., a value of 110111b indicates that the MSB of byte 1 of the Clock Count field is the highest bit that contains meaningful information);
- d) **CS\_Implemented\_LSB:** This field is a value that is constrained to the range of 0 to 63. It represents the least significant bit position within the Clock Count field that shall contain meaningful information (e.g., a value of 001000b indicates that the LSB of byte 6 of the Clock Count field is the lowest bit that contains meaningful information); and
- e) **CS\_Update\_Period:** This field is a value. It represents the time, in microseconds, between consecutive updates from the Clock Synchronization server.

### 4.3.30 Clock Synchronization Update (CSU)

#### 4.3.30.1 Description

The CSU ELS is used by the Clock Synchronization Server to send its current clock value to its clients (see FC-FS-3).

#### 4.3.30.2 Protocol

- a) Clock Synchronization Update Request Sequence; and
- b) No Reply Sequence.

#### 4.3.30.3 Request Sequence

**Information Category:** The Information Category value (Header word 0, bits 24-27) shall indicate Solicited Data (0001b).

**Addressing:** The S\_ID field designates the Clock Synchronization Server well-known address (FFFFF6h). The D\_ID field designates the Nx\_Port(s) that is/are to receive the clock information.

**Payload:** The format of the Payload is shown in table 92.

**Table 92 – CSU Payload**

Bits Word	31 .. 24	23 .. 16	15 .. 08	07 .. 00
0	CSU (69h)	Reserved		
1	Clock Count (8 bytes)			
2				

The meaning of the Clock Count field is given in table 93.

**Table 93 – Clock Count Field Meaning**

Byte Number	Meaning
0	Counter value, byte 0 (MSB)
1	Counter value, byte 1
2	Counter value, byte 2
3	Counter value, byte 3
4	Counter value, byte 4
5	Counter value, byte 5
6	Counter value, byte 6
7	Counter value, byte 7 (LSB)

The bit values are derived from clock frequencies that are used in 1Gbits/s Fibre Channel and shall be defined as follows. The value of the Bit 7 in Word 2 shall be equal to 1/106.25MHz, roughly 9.4 ns.



Every other bit value is a binary multiple of this value. The next most significant bit is 2x that value, or 18.8ns. The next least significant value is ½ that value, or 4.7ns. The overall least significant bit is 73.5ps. The overall range that may be represented is 1.36 x 10<sup>9</sup> sec, approximately equal to 43 years.

The Clock Count value shall represent the time at which the most significant bit was placed on the link by the CSU ELS originator.

Any bits outside the range of CS\_Implemented\_MSB to CS\_Implemented\_LSB shall be set to zero. This applies to both the Clock Sync Server and to the Fabric.

**4.3.30.4 Reply Sequence**

none.

**4.3.31 Report Port Buffer Conditions (RPBC)**

**4.3.31.1 Description**

The RPBC ELS shall provide a method for a Port to report its buffer conditions. The normal response to an RPBC ELS Sequence shall be a LS\_ACC ELS Sequence. If the recipient Port does not support the RPBC ELS, it shall reply with an LS\_RJT ELS Sequence with a reason code of “Command not supported”.

**4.3.31.2 Protocol**

- a) Report Port Buffer Conditions (RPBC) Request Sequence; and
- b) LS\_ACC or LS\_RJT Reply Sequence.

**4.3.31.3 Request Sequence**

**Addressing:** The S\_ID designates the source Nx\_port that is requesting port buffer conditions. The D\_ID field designates the destination Nx\_Port or F\_Port Controller (FFFFFFEh).

**Payload:** The format of the RPBC Payload is shown in table 94.

**Table 94 – RPBC Payload**

Bits Word	31 .. 24	23 .. 16	15 .. 08	07 .. 00
0	RPBC (58h)	Reserved		
1	ELS Buffer Parameters			
2	Reserved	Originator S_ID - obsolete		

The ELS Buffer Parameter field contained in word 1 of the RPBC Payload relates to the ELS buffer conditions of the sender of the RPBC ELS and the contents are shown in table 95.

**Table 95 – ELS Buffer Parameters Field**

Bits	Field Name
31	Multi-frame ELS sequence supported
30-12	Reserved.
11-00	ELS Receive Data_Field Size

The Multi-frame ELS sequence supported bit indicates that the port either supports multi-frame ELS's (bit 31=1) or does not support multi-frame ELS's (bit 31=0).

The ELS Receive Data\_Field Size field (word 1, bits 11-0) specifies the largest ELS frame that may be received by the FC\_Port responding with the RPBC LS\_ACC. Values shall be a multiple of four bytes, and less than 128 or greater than 2 112 are invalid. For each class of service, the maximum usable ELS Receive Data\_Field Size is the lessor of the reported ELS Receive Data\_Field Size or the Buffer-to-Buffer Receive Data\_Field Size reported during Login.

**4.3.31.4 Reply Sequence**

**LS\_RJT:** LS\_RJT signifies rejection of the RPBC command

**LS\_ACC:** LS\_ACC signifies acceptance of the RPBC Request and its Accept Payload. The format of the RPBC LS\_ACC Payload is shown in table 96.

**Table 96 – RPBC LS\_ACC Payload**

Bits Word	31 .. 24	23 .. 16	15 .. 08	07 .. 00
0	02h	Reserved		
1	ELS Buffer Parameters			

The ELS Buffer Parameter field contained in word 1 of the RPBC LS\_ACC Payload relates to the ELS buffer conditions of the sender of the RPBC LS\_ACC ELS and the contents are shown in table 95.

**4.3.32 Report node FC-4 Types (RNFT)**

**4.3.32.1 Description**

The RNFT ELS provides for the exchange of supported FC-4 protocol lists. It may be used any time after N\_Port Login to verify that the remote Nx\_Port supports a given FC-4 protocol.

The RNFT requests a list of the FC-4 protocols supported by the responder, and the RNFT LS\_ACC provides the requested list to the source of the RNFT.

A specific FC-4 may require that its Nx\_Ports support RNFT, and therefore may conclude that a remote Nx\_Port that returns LS\_RJT with reason code of "Command not supported" does not support that FC-4.

### 4.3.32.2 Protocol

- a) Report node FC-4 Types (RNFT) Request sequence; and
- b) LS\_ACC or LS\_RJT Reply Sequence.

### 4.3.32.3 Request Sequence

**Addressing:** The S\_ID field designates the source Nx\_Port requesting the FC-4 Types information. The D\_ID field designates the destination Nx\_Port to which the request is being made.

**Payload:** The format of the request Payload is shown in table 97.

**Table 97 – RNFT Payload**

Bits Word	31 .. 24	23 .. 16	15 .. 08	07 .. 00
0	RNFT (63h)	Reserved	Maximum Size	
1	Reserved			Index

- a) **Maximum Size:** Bytes 2-3 of Word 0 contain a 16-bit value that specifies the maximum length of the RNFT LS\_ACC that the originator is able to accept. The value zero implies the RNFT LS\_ACC may be any size;
- b) **Index:** Byte 3 of Word 1 contains an 8-bit value that specifies the index of the first FC-4 Entry to be returned in the RNFT Reply; and

Each FC-4 protocol supported by the responder has an index in the range from zero to (List Length – 1) that should be used to specify a subset of the entries if the entire list does not fit into one reply. NOTE - The index of the entry for a particular FC-4 TYPE may not be consistent between subsequent RNFT Requests (e.g., due to additions or deletions of supported FC-4 TYPES).

### 4.3.32.4 Reply Sequence

**LS\_RJT:** LS\_RJT signifies rejection of the RNFT command.

**LS\_ACC:** LS\_ACC Signifies that the destination Nx\_Port has transmitted the requested data. The format of the LS\_ACC Payload is shown in table 98.

**Table 98 – RNFT LS\_ACC Payload**

Bits Word	31 .. 24	23 .. 16	15 .. 08	07 .. 00
0	02h	Reserved	Payload Length (M)	
1	Reserved	List Length	Reserved	Index
2	FC-4 Entry 1			
..	...			
N+1	FC-4 Entry N			

- a) **Payload Length:** Bytes 2-3 of Word 0 contain a 16-bit value that specifies the length M of the RNFT LS\_ACC Payload in bytes:

$$M = 8 + N \times 4$$

where

N is the number of FC-4 Entries contained in the Payload;

- b) **List Length:** Byte 1 of Word 1 contains an 8-bit value that specifies the total number of FC-4 protocols supported by the responder.

If List Length exceeds Index+N then the originator may request additional records with another RNFT in which Index is increased by N;

- c) **Index:** Byte 3 of Word 1 contains an 8-bit value that specifies the index of the first FC-4 Entry returned in the RNFT reply; and
- d) **FC-4 Entry:** The FC-4 Entry record contains a FC-4 Entry and is shown in table 99.

**Table 99 – RNFT FC-4 Entry**

Bits Word	31 .. 24	23 .. 16	15 .. 08	07 .. 00
1	FC-4 Type	FC-4 Qualifier		

- A) **FC-4 Type:** The FC-4 TYPE code of a FC-4 protocol that is supported by the sending Nx\_Port. The values are defined in FC-FS-3; and
- B) **FC-4 Qualifier:** The FC-4 Qualifier may be used to distinguish between two protocols that use the same FC-4 TYPE code.

For FC-4 type codes that are reserved or assigned for specific use in this standard (00h - DFh), the value of the FC-4 Qualifier shall be zero.

For Vendor specific FC-4 TYPE codes (E0h through FFh), the FC-4 Qualifier shall be selected from one of the 24-bit Company\_ID values assigned by the IEEE Registration Authority to the organization that defines the Vendor specific FC-4 protocol, and that Company\_ID shall be used to qualify that FC-4 TYPE in all implementations. It is up to the organization that defines the Vendor specific FC-4 protocol to assure that the protocol has a unique qualified FC-4 Type.

### 4.3.33 Scan Remote Loop (SRL)

#### 4.3.33.1 Description

The SRL ELS shall require a switch to scan attached loops to determine if any L\_Ports have been disabled or removed. If the switch determines any L\_Ports that are currently logged in with the Fabric have been removed or disabled it shall update the name server and send an RSCN to all registered Nx\_Ports.

The SRL Payload indicates whether the switch shall scan all attached loops or a single loop. If a single loop is to be scanned the Payload shall contain the FL\_Port\_ID of the loop to be scanned.

### 4.3.33.2 Protocol

- a) Scan Remote Loop Request Sequence; and
- b) LS\_ACC or LS\_RJT Reply Sequence.

### 4.3.33.3 Request Sequence

**Addressing:** The S\_ID field designates the source Nx\_Port requesting Scan Remote Loop. The D\_ID field designates the destination of the address identifier for the Domain Controller of the switch for which loops are being scanned. The format of the Domain Controller address is FFFCh || Domain\_ID. Domain\_ID is the Domain\_ID of the switch being queried.

**Payload:** The format of the Payload is shown in table 100.

**Table 100 – SRL Payload**

Bits Word	31 .. 24	23 .. 16	15 .. 08	07 .. 00
0	SRL (7Bh)	Reserved		
1	Flag	Flag Parameter		

- a) **Flag:** Byte 0 of word 1 indicates if the FL\_Port shall be scanned, if all FL\_Ports within the domain shall be scanned, or the scan period that all FL\_Ports within the domain shall be scanned. The meaning of bits 0-7 is given in Table 101; and

**Table 101 – Flag field definitions**

Value (hex)	Meaning	Flag Parameter
00	All the FL_Ports within the domain shall be scanned.	Ignored
01	Only the loop attached to the FL_Port addressed in the address identifier of the FL_Port field shall be scanned.	Address identifier of the FL_Port
02	Enable periodic scanning for all FL_ports.	Scan period <sup>a</sup>
03	Disable periodic scanning for all FL_ports.	Ignored
All Others	Reserved	

<sup>a</sup> Scan period in seconds. If the scan period is set to zero the scan period is vendor specific. If the switch does not support this option it shall reject the SRL ELS with a reason code of “Unable to perform command request” and a reason code explanation of “Periodic Scanning not supported”. If the switch does not support the selected value it shall reject the SRL ELS with a reason code of “Unable to perform command request” and a reason code explanation of “Periodic Scan Value not allowed”.

- b) **Flag Parameter:** See Table 101.

### 4.3.33.4 Reply Sequence

**LS\_RJT:** LS\_RJT signifies the rejection of the SRL Request

**LS\_ACC:** LS\_ACC signifies acceptance of the SRL Request. If the period scanning is enabled then the switch shall return the value of the periodic scanning period in the LS\_ACC payloads Scan Period field, If the periodic scanning period is disabled then the switch shall set the LS\_ACC payload Scan Period field to zero.

**Table 102 – SRL LS\_ACC Payload**

Bits Word	31 .. 24	23 .. 16	15 .. 08	07 .. 00
0	02h	Scan Period		

**4.3.34 Set Bit-error Reporting Parameters (SBRP)**

**4.3.34.1 Description**

Set SBRP ELS is used to communicate a set of bit error reporting parameters to a Port or to all Ports in a particular Domain in a Fabric. There are 3 parameters, Error Interval, Error Window, and Error Threshold. Error Interval is the time period over which bit error bursts are integrated to produce a single reported error. An Error Window is composed of one or more Error Intervals. The Error Interval Count is the number of Error Intervals occurring in an Error Window. If the Error Interval Count is greater than or equal to the Error Threshold, a Registered Link Incident Report (RLIR) is generated with an Incident Code specifying Bit-error-rate threshold exceeded (see FC-FS-3). At the end of the Error Window, the count is set to zero and the process is repeated. See figure 2 for illustration of the parameters.

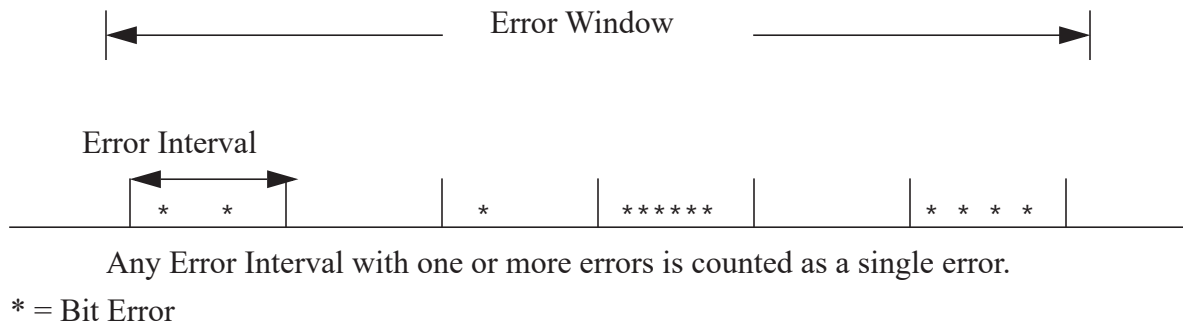

**Figure 2 – Illustration of parameters**

SBRP may be used to determine an acceptable set or the current set of bit error reporting parameters in the destination Port or Domain, without changing the settings.

The setting of parameters in a particular Port or Domain is done by a controlling entity that is outside the scope of this standard.

**4.3.34.2 Protocol**

- a) Set Bit-error Reporting Parameters (SBRP) Request Sequence; and
- b) LS\_ACC or LS\_RJT Reply Sequence.

### 4.3.34.3 Request Sequence

**Addressing:** The S\_ID designates the source Nx\_Port requesting the bit error rate reporting parameters. The D\_ID designates the destination Nx\_Port or the Domain Controller (FFFCh || <Domain\_ID>). Domain\_ID is the Domain\_ID of the recipient switch) to process the SBRP ELS.

**Payload:** The format of the SBRP Payload is shown in table 103.

**Table 103 – SBRP Payload**

Bits Word	31 .. 28	27 .. 24	23 .. 16	15 .. 12	11 .. 08	07 .. 03	02 .. 00
0	SBRP (7Ch)		00h	00h		00h	
1	Error Flags						
2	Error Window exponent	Error Window value		Error Interval exponent	Error Interval value		
3	Error Threshold						

- a) **Error Flags:** The following bits are mutually exclusive and only one bit shall be set for each instance of the SBRP ELS:

Bit 0 – Set Error Reporting Parameters: The bit is set to request that the destination set the Error Window, the Error Interval and the Error Threshold parameters. If the destination is the Domain Controller then the request is for the switch to set all ports to the requested values,

Bit 1 – Report Error Reporting Parameters: The bit is set to request that the destination return the active parameters, currently being enforced,

Bits 2-31: Reserved;

- b) **Error Window exponent and Error Window value:** The Error Window is a time duration described by a 16-bit value. Twelve bits, Bits 28-16, are used for the base value. Four bits, Bits 31-28 are encoded to form the exponent. The product of the base value and the exponent yields the time duration in seconds. The encoded exponent is defined as follows:

0h represents  $10^0$

1h represents  $10^{-1}$

2h represents  $10^{-2}$

·  
·  
·

Fh represents  $10^{-15}$

(e.g., a base value of 300h multiplied by an exponent of 0h would yield a value of 1 times  $10^{-0}$  or 300h seconds). The tolerance for the Error Window is -0 to + 1 Error Interval;

- c) **Error Interval exponent and Error Interval value:** The Error Interval is a time duration in seconds and has the same definitions for exponent and base value as Error Window (e.g., a base value of 15 multiplied by an exponent of 1h would yield a value of 15 times  $10^{-1}$  or 1.5 seconds). The Error Interval has a tolerance of – 50% to + 50%; and
- d) **Error Threshold:** The Error Threshold fields specifies the basis for a comparison value with the Error Interval Count.

#### 4.3.34.4 Reply Sequence

**LS\_RJT:** LS\_RJT signifies the rejection of the SBRP Request.

**LS\_ACC:** LS\_ACC signifies acceptance of the SBRP Request and presents SBRP data. The format of the LS\_ACC Payload is shown in table 104.

The LS\_ACC Payload conveys either:

- a) the current Bit Error Rate Reporting Parameters (i.e., the requestor is querying for currently set parameters);
- b) the accepted Bit Error Rate Reporting Parameters (i.e., a request to set the parameters was accepted); or
- c) acceptable Bit Error Rate Report Parameters (i.e., a request to set the parameters was rejected because the parameters requested are not within the range supported by the port or switch).

**Table 104 – SBRP LS\_ACC Payload**

Bits Word	31	30 .. 28	27 .. 24	23 .. 16	15 .. 12	11 .. 08	07 .. 00
0	02h			00h	00h		00h
1	SBRP Request Accepted	Reserved					
2	Error Window exponent		Error Window value		Error Interval exponent	Error Interval value	
3	Error Threshold						

- a) **SBRP Request Accepted:** If a request to set the reporting parameters is indicated (i.e., request Payload word 1 bit 0 is set to one) and the recipient accepts the requested parameters, it shall set the SBRP Request Accepted bit to zero (i.e., Accepted) and echo the requested Error Window, Interval and Threshold parameters in words 2 and 3.

If a request to set the reporting parameters is indicated (i.e., request Payload word 1 bit 0 is set to one) and the recipient does not accept the parameters as requested the recipient shall set the SBRP Request Accepted bit to one and echo in words 2 and 3 those parameters that are accepted. Values not accepted by the recipient shall be set to zero.

If a request to report the parameters is indicated (i.e., request Payload word 1 bit 1 is set to one) the recipient shall set the SBRP Request Accepted bit to zero (i.e., Accepted) report the



current Bit Error Rate reporting parameters being enforced. If no Bit Error Rate reporting is being enforced, words 2 and 3 shall be set to zero.

### 4.3.35 Query Security Attributes (QSA) Version 2

#### 4.3.35.1 Overview

The Query Security Attributes (QSA) ELS allows an N\_Port\_ID to obtain a summary of selected Fabric-wide policies and register for notifications of relevant policy changes. N\_Port\_IDs may use the returned policy summary to determine if the Fabric provides the level of security required in their particular environment (see FC-SP-2).

#### 4.3.35.2 QSA Version 2 Request Sequence

**Protocol:** Query Security Attributes (QSA) Request Sequence

**Addressing:** The S\_ID designates the source N\_Port\_ID that is requesting policy summary. The D\_ID field designates the Fabric Controller (FFFFFDh).

**Payload:** The format of the QSA request payload is shown in table 105.

**Table 105 – QSA Request Payload**

Item	Size (Bytes)
7E00 0000h	4
Revision	4
Enforced Security Attribute Registration Mask	4
Extended Security Attribute Registration Mask	4

**Revision:** Shall be set to 0000 0002h.

**Enforced Security Attribute Registration Mask:** A bit field that registers the N\_Port\_ID for change notification for the enforced Fabric Security Attributes. The defined bits are shown in table 106.

**Table 106 – Enforced Security Attribute Registration Mask**

Bit	Description
31 .. 2	Reserved
1	<b>Insistent Domain_ID Change Notification:</b> If set to one indicates that change notification is required for the Insistent Domain_ID Enforced Security Attribute. If set to zero indicates that change notification for the Insistent Domain_ID Enforced Security Attribute shall not be performed.
0	<b>Fabric Binding Change Notification:</b> If set to one indicates that change notification is required for the Fabric Binding Enforced Security Attribute. If set to zero indicates that change notification for the Fabric Binding Enforced Security Attribute shall not be performed.

**Extended Security Attribute Registration Mask:** A bit field that registers the N\_Port ID for change notification for the extended Fabric Security Attributes. The defined bits are shown in table 107.

**Table 107 – Extended Security Attribute Registration Mask**

Bit	Description
31 .. 1	Reserved
0	Vendor Specific

#### 4.3.35.3 QSA Version 2 Reply Sequence

**LS\_RJT:** LS\_RJT shall be sent as a reply to signify the rejection of the QSA Request Sequence.

**LS\_ACC:** LS\_ACC shall be sent as a reply to signify the acceptance of the QSA Request Sequence for processing. The format of the QSA LS\_ACC payload is shown in table 108.

**Table 108 – QSA LS\_ACC Payload**

Item	Size (Bytes)
0200 0000h	4
Revision	4
Enforced Security Attribute Field	4
Extended Security Attribute Field	4

**Revision:** Shall be set to 0000 0002h.

**Enforced Security Attribute Field:** A bit field describing the security attributes currently enforced by the Fabric. The defined bits are shown in table 109.

**Table 109 – Enforced Security Attribute Field**

Bit	Description
31 .. 2	Reserved
1	<b>Insistent Domain_ID:</b> If set to one indicates that the Fabric is currently enforcing a policy that requires all Switches to exploit the Insistent Domain_ID behavior, as defined in FC-SP-2. This may be done by the Fabric enforcing a non-NULL Switch Membership List not containing a wildcard entry, and with all Switches listed in the Switch Membership List having the Insistent Domain_ID flag set to one and the Domain_ID attribute not set to zero (see FC-SP-2).
0	<b>Fabric Binding:</b> If set to one indicates that the Fabric is currently enforcing a policy that allows only certain administratively specified Switches to be part of the Fabric itself. This may be done by the Fabric enforcing a non-NULL Switch Membership List not containing only a wildcard entry or by vendor specific methods (see FC-SP-2).

**Extended Security Attributes Field:** A bit field describing the extended security attributes currently enforced by the Fabric. The defined bits are shown in table 110.

**Table 110 – Extended Security Attribute Field**

Bit	Description
31 .. 1	Reserved
0	<b>Vendor Specific:</b> Enabled if the bit is set to one, disabled if the bit is set to zero.

#### 4.3.36 Report Port Speed Capabilities (RPSC)

##### 4.3.36.1 Description

The RPSC ELS shall provide a method for a Port to report its current and potential link operating speeds. The normal response to an RPSC ELS Sequence shall be a LS\_ACC ELS Sequence. If the recipient Port does not support the RPSC ELS, it shall reply with an LS\_RJT ELS Sequence with a reason code of “Command not supported”.

##### 4.3.36.2 Protocol

- a) RPSC Request Sequence; and
- b) LS\_ACC or LS\_RJT Reply Sequence.

##### 4.3.36.3 Request Sequence

**Addressing:** The S\_ID designates the source Nx\_Port that is requesting port speeds. The D\_ID field designates the destination Nx\_Port or F\_Port Controller (FFFFFFEh).

**Payload:** The format of the RPSC Payload is shown in table 111.

**Table 111 – RPSC Payload**

Bits Word	31 .. 24	23 .. 16	15 .. 08	07 .. 00
0	RPSC (7Dh)	00h	00h	00h

##### 4.3.36.4 Reply Sequence

**LS\_RJT:** LS\_RJT signifies the rejection of the RPSC Request.

**LS\_ACC:** LS\_ACC signifies acceptance of the RPSC Request. The format of the LS\_ACC Payload is shown in table 112.

**Table 112 – RPSC LS\_ACC Payload**

Bits Word	31 .. 24	23 .. 16	15 .. 8	7 .. 0
0	02h	Flags	Number of entries	
1	Port Speed Capabilities		Port Operating Speed	

**Flags:** The following bits are defined:

Bit 23 .. 17: Reserved.

Bit 16: Phy Type. Shall be set to zero to indicate a FC-FS-4 PN\_Port or PF\_Port Phy Type. Shall be set to one to indicate a Lossless Ethernet MAC Phy Type.

**Number of Entries:** Shall be set to 1.

**Port Speed Capabilities:** Identifies the operating speed capabilities of the port, as shown in table 113.

**Table 113 – Port Speed Capabilities**

Bit	FC-FS-4 PN_Port or PF_Port Phy Type	Lossless Ethernet MAC Phy Type
31	1GFC capable	1GE capable
30	2GFC capable	10GE capable
29	4GFC capable	40GE capable
28	10GFC capable	100GE capable
27	8GFC capable	25GE capable
26	16GFC capable	50GE capable
25	32GFC capable	400GE capable
24	64GFC capable	Reserved
23	128GFC capable	Reserved
22	256GFC capable	Reserved
21 .. 18	Reserved	Reserved
17	Configured: this bit shall be set to one to indicate the Port Operating Speed is administratively configured to one of the supported Port Speed Capabilities	
16	Unknown	

**Port Operating Speed:** Identifies the current operating speed if set, as shown in table 114.

**Table 114 – Port Operating Speed**

Bit	FC-FS-4 PN_Port or PF_Port Phy Type	Lossless Ethernet MAC Phy Type
15	1GFC operation	1GE operation
14	2GFC operation	10GE operation
13	4GFC operation	40GE operation
12	10GFC operation	100GE operation
11	8GFC operation	25GE operation
10	16GFC operation	50GE operation
9	32GFC operation	400GE operation
8	64GFC operation	Reserved
7	128GFC operation	Reserved
6	256GFC operation	Reserved
5 .. 2	Reserved	Reserved
1	Unknown	
0	Speed not established	
<sup>a</sup> Applicable only when the D_ID is a WKA other than the desired port (e.g., RDP sent to the Domain Controller). {CWC: Statement needs to be fixed a D_ID is not a WKA, and what does "desired port" mean?}		

If Bit 17 of Port Speed Capabilities is set to one, the Port Operating Speed bit corresponding to the configured port speed shall be set to one. If the port is currently not in an active state, bit 0 shall also be set to one.

### 4.3.37 Read Exchange Concise (REC)

#### 4.3.37.1 Description

This ELS shall be used only for purposes specific to an FC-4. The REC (Read Exchange Concise) Extended Link Service requests an Nx\_Port to return Exchange information for the RX\_ID and OX\_ID originated by the S\_ID specified in the Payload of the request Sequence.

A Read Exchange Concise Request shall only be accepted if the Originator Nx\_Port N\_Port\_ID or the Responder Nx\_Port N\_Port\_ID of the target Exchange is the same as the N\_Port\_ID of the Nx\_Port that makes the request. If the REC Request is not accepted, an LS\_RJT with reason code "Unable to perform command request" and reason code explanation "Invalid Originator S\_ID" shall be returned.

The specification of OX\_ID and RX\_ID shall be provided for the destination Nx\_Port to locate the status information requested. A Responder destination Nx\_Port shall use the RX\_ID and verify that the OX\_ID is consistent, unless the RX\_ID is unassigned (i.e., RX\_ID = FFFFh). If the RX\_ID is unassigned in the request, the Responder shall identify the Exchange by means of the S\_ID specified in the Payload of the request Sequence and OX\_ID. An Originator Nx\_Port shall use the OX\_ID and verify that the RX\_ID is consistent.

If the destination Nx\_Port of the REC request determines that the Originator S\_ID, OX\_ID, or RX\_ID are inconsistent, then it shall reply with an LS\_RJT Sequence with a reason code of "Unable to perform command request" and a reason code explanation of "Invalid OX\_ID-RX\_ID combination".

The value of the Parameter field in the Frame\_Header of an REC ELS and an LS\_ACC in response to an REC ELS shall be specified by the FC-4 that sends the frame. The Relative offset present bit in the Frame\_Header of an REC ELS or an LS\_ACC in response to an REC ELS shall be set to zero.

**4.3.37.2 Protocol**

- a) Read Exchange Concise (REC) Request Sequence; and
- b) LS\_ACC or LS\_RJT Reply Sequence.

**4.3.37.3 Request Sequence**

**Addressing:** The S\_ID designates the source port that is requesting exchange information. The D\_ID field designates the recipient that is requested to provide exchange information.

**Payload:** The format of the REC Payload is shown in table 115.

**Table 115 – REC Payload**

Bits Word	31 .. 24 Byte 0	23 .. 16 Byte 1	15 .. 08 Byte 2	07 .. 00 Byte 3
0	REC (13h)	00h	00h	00h
1	Reserved	Exchange Originator S_ID		
2	OX_ID		RX_ID	

**Exchange Originator S\_ID:** shall be set to the address identifier of the target Exchange Originator.

**OX\_ID:** shall be set to the Originator Exchange\_ID value of the target Exchange.

**RX\_ID:** shall be set to the Responder Exchange\_ID value of the target Exchange.

**4.3.37.4 Reply Sequence**

**LS\_RJT:** LS\_RJT signifies the rejection of the REC Request

**LS\_ACC:** LS\_ACC signifies acceptance of the REC Request and returns the requested exchange information. The format of the LS\_ACC Payload is shown in table 116.

**Table 116 – REC LS\_ACC Payload**

Bits Word	31 .. 24 Byte 0	23 .. 16 Byte 1	15 .. 08 Byte 2	07 .. 00 Byte 3
0	LS_ACC (02h)	00h	00h	00h
1	OX_ID		RX_ID	
2	Reserved	Originator Address Identifier		
3	Reserved	Responder Address Identifier		
4	FC4VALUE			
5	E_STAT			

The Originator Address Identifier field shall be set to the address identifier of the Originator of the exchange about which information was requested.

The Responder Address Identifier field shall be set the address identifier of the Responder of the exchange about which information was requested.

The value of the FC4VALUE field shall be specified by the FC-4 that sends the LS\_ACC to a REC ELS.

E\_STAT shall be as defined in FC-FS-3 for the E\_STAT field in the Exchange Status Block for the exchange about which information was requested. The bits specifying whether the Exchange is complete (i.e., Bit 29) and whether the responder holds Sequence Initiative (i.e., Bit 30) shall be valid. The setting of other bits may not be valid.

#### 4.3.38 Exchange Virtual Fabrics Parameters (EVFP)

##### 4.3.38.1 EVFP Messages Structure

###### 4.3.38.1.1 EVFP Request Sequence

**Protocol:** Exchange Virtual Fabrics Parameters (EVFP) Request Sequence

**Addressing:** If an EVFP ELS is transmitted from a PN\_Port, the S\_ID field shall be set to FFFFF0h, indicating the N\_Port Controller of the originating PN\_Port. The D\_ID field shall be set to FFFFFEh, indicating the F\_Port Controller of the destination PF\_Port. If an EVFP ELS is transmitted from a PF\_Port, the S\_ID field shall be set to FFFFFEh, indicating the F\_Port Controller of the originating

PF\_Port. The D\_ID field shall be set to FFFFF0h, indicating the N\_Port Controller of the destination PN\_Port.

**Payload:** Two types of EVFP messages are defined. All EVFP Request messages share the same message structure, shown in table 117.

**Table 117 – EVFP Request Payload**

Bits Word	31 .. 24	23 .. 16	15 .. 08	07 .. 00
0	EVFP (7Fh)	00h	00h	00h
1	Protocol Version	Message Code	Transaction Identifier	
2	MSB		Core N_Port_Name /	
3			Core Switch_Name LSB	
4	Reserved		Message Payload Length	
5	MSB			
..			Message Payload	
N			LSB	

**Protocol Version:** Shall be set to one.

**EVFP Message Code:** Specifies the EVFP message that is to be transmitted from the source to the destination. The defined EVFP message codes are shown in table 118.

**Table 118 – EVFP Message Codes**

Value	Description	Reference
01h	EVFP_SYNC	4.3.38.2
02h	EVFP_COMMIT	4.3.38.3
all others	Reserved	

**Transaction Identifier:** Uniquely identifies an EVFP transaction between two entities. The Transaction Identifier shall be set by the EVFP Initiator, and each subsequent EVFP message shall contain the same value, until the EVFP transaction is completed.

NOTE 4 – The usage of the Transaction Identifier is very similar to the usage of an OX\_ID if an Exchange Originator is enforcing uniqueness via the OX\_ID mechanism (see FC-FS-3), but it is not related in any way to the OX\_ID present in the Fibre Channel frames carrying the EVFP messages.

**Core N\_Port\_Name / Core Switch\_Name:** If the EVFP ELS is transmitted from a PN\_Port, this field shall be set to its Core N\_Port\_Name. If the EVFP ELS is transmitted from a PF\_Port, this field shall be set to the Core Switch\_Name of the Switch it belongs to.

**Payload Length:** Shall be set to the total length in bytes of the EVFP Payload (i.e., 20 + the Message Payload length).



### 4.3.38.1.2 EVFP Reply Sequence

Accept (LS\_ACC)

Signifies acceptance of the EVFP request.

**Accept Payload:** All EVFP Accept messages share the same message structure, shown in table 119.

**Table 119 – EVFP Accept Payload**

Bits Word	31 .. 24	23 .. 16	15 .. 08	07 .. 00
0	02h	00h	00h	00h
1	Protocol Version	Message Code	Transaction Identifier	
2	MSB		Core N_Port_Name /	
3			Core Switch_Name LSB	
4	Reserved		Message Payload Length	
5	MSB			
..			Message Payload	
N			LSB	

The fields in table 119 are the same as defined in table 117.

Service Reject (LS\_RJT)

Signifies the rejection of the EVFP request

Table 120 shows the use of reason codes and reason code explanations under some error conditions.

**Table 120 – LS\_RJT Reason Codes for EVFP**

Error Condition	Reason Code	Reason Code Explanation
EVFP ELS not supported	Command not supported	No additional explanation
EVFP collision	Command already in progress	No additional explanation
Protocol Version not supported	Protocol error	No additional explanation
EVFP_COMMIT before EVFP_SYNC	Logical error	No additional explanation
Insufficient Resources	Unable to perform command request	No additional explanation
Invalid Payload Message	Protocol error	No additional explanation

**4.3.38.2 EVFP\_SYNC Message Payload**

**4.3.38.2.1 Overview**

The EVFP\_SYNC Message Payload carries a list of descriptors. Each descriptor is self-identifying (see table 122). The format of the EVFP\_SYNC Message Payload is shown in table 121. This Message Payload is used in both EVFP\_SYNC Request and EVFP\_SYNC Accept.

**Table 121 – EVFP\_SYNC Message Payload**

Bits Word	31 .. 24	23 .. 16	15 .. 08	07 .. 00
0	Descriptor #1 = Tagging Administrative Status (see 4.3.38.2.2) <sup>a</sup>			
1				
2	Descriptor #2 = Port VF_ID (see 4.3.38.2.3) <sup>b</sup>			
3				
4	Descriptor #3 = Locally-Enabled VF_ID List (see 4.3.38.2.4) <sup>c</sup>			
..				
132				
...	...			
H				
...	Descriptor #m			
K				
<sup>a</sup> Descriptor #1 is required to be present in EVFP_SYNC request. <sup>b</sup> Descriptor #2 is required to be present in EVFP_SYNC request. <sup>c</sup> Descriptor #3 is required to be present in EVFP_SYNC request.				

All descriptors share the same format, shown in table 122.

**Table 122 – Descriptor Format**

Bits Word	31 .. 24	23 .. 16	15 .. 08	07 .. 00
0	Descriptor Control	Descriptor Type	Descriptor Length	
1	MSB			
..	Descriptor Value			
M				

**Descriptor Control:** Specifies the behavior of the receiving entity if the descriptor is unsupported. The defined codes are shown in table 123.

**Table 123 – Descriptor Control Codes**

Value	Description
01h	Critical. Abort the EVFP transaction if the descriptor is unsupported. <sup>a</sup>
02h	Non critical. Skip the descriptor if unsupported and continue the EVFP transaction. <sup>a</sup>
all others	Reserved

<sup>a</sup> The Descriptor Control provides extensibility to the protocol. An implementation supporting a subset of the descriptors is able to process the unknown ones as specified by the Descriptor Control value.

**Descriptor Type:** Specifies the type of the descriptor. The defined descriptors are summarized in table 124.

**Table 124 – Descriptor Types**

Value	Description	Reference
01h	Tagging Administrative Status Descriptor	4.3.38.2.2
02h	Port VF_ID Descriptor	4.3.38.2.3
03h	Locally-Enabled VF_ID List Descriptor	4.3.38.2.4
F0h .. FEh	Vendor Specific Descriptor	4.3.38.2.5
all others	Reserved	

**Descriptor Length:** Specifies the length in bytes of the Descriptor Value.

**4.3.38.2.2 Tagging Administrative Status Descriptor**

The format of the Tagging Administrative Status descriptor is shown in table 125.

**Table 125 – Tagging Administrative Status Descriptor**

Bits Word	31 .. 24	23 .. 16	15 .. 08	07 .. 00
0	Descriptor Control = 01h	Descriptor Type = 01h	Descriptor Length = 0004h	
1	Administrative Tagging Mode			

The defined Administrative Tagging Modes are shown in table 126.

**Table 126 – Administrative Tagging Modes**

Value	Notation	Description
0000 0001h	OFF	The FC_Port shall not perform VFT Tagging.
0000 0002h	ON	The FC_Port may perform VFT Tagging if the peer does not prohibit it.
0000 0003h	AUTO	The FC_Port may perform VFT Tagging if the peer requests it.
all others	Reserved	

In absence of any explicit configuration, the default Administrative Tagging Mode of a VF capable N\_Port or F\_Port should be AUTO.

Table 127 shows how VFT tagging is negotiated between peer FC\_Ports.

**Table 127 – Tagging Mode Negotiation**

		Peer Tagging Mode		
		OFF	ON	AUTO
Local Tagging Mode	OFF	Non Tagging	Non Tagging	Non Tagging
	ON	Non Tagging	Tagging	Tagging
	AUTO	Non Tagging	Tagging	Non Tagging

#### 4.3.38.2.3 Port VF\_ID Descriptor

The format of the Port VF\_ID descriptor is shown in table 128.

**Table 128 – Port VF\_ID Descriptor**

Bits Word	31 .. 24	23 .. 16	15 .. 08	07 .. 00
0	Descriptor Control = 01h	Descriptor Type = 02h	Descriptor Length = 0004h	
1	Port Flags		Port VF_ID	

**Port Flags:** Reserved. Shall be set to zero.

**Port VF\_ID:** The 12 least significant bits of this field shall be set to the Port VF\_ID. The four most significant bits shall be set to zero. In the absence of any explicit configuration, the value 001h should be used as Port VF\_ID.

#### 4.3.38.2.4 Locally-Enabled VF\_ID List Descriptor

The format of the Locally-Enabled VF\_ID List descriptor is shown in table 129.

**Table 129 – Locally-Enabled VF\_ID List Descriptor**

Bits Word	31 .. 24	23 .. 16	15 .. 08	07 .. 00
0	Descriptor Control = 01h	Descriptor Type = 03h	Descriptor Length = 0200h	
1	MSB			
..	VF_ID Bitmap			
128	LSB			

**VF\_ID Bitmap:** Each Virtual Fabric is identified by a bit in the VF\_ID Bitmap. The high-order bit represents VF\_ID zero, each successive bit represents the successive VF\_ID, and the low-order bit represents VF\_ID 4095. Virtual Fabric K is allowed on the Interconnect\_Port if the Kth bit of the VF\_ID Bitmap is set to one and is disallowed if the Kth bit of the VF\_ID Bitmap is set to zero. The bit representing the Control VF\_ID (see FC-FS-3) shall be set to zero.

The list of Virtual Fabrics operational over a link is computed by performing a bit-wise 'AND' between the received VF\_ID Bitmap and the locally configured VF\_ID Bitmap.

#### 4.3.38.2.5 Vendor Specific Descriptor

The format of the Vendor Specific descriptor is shown in table 130.

**Table 130 – Vendor Specific Descriptor**

Bits Word	31 .. 24	23 .. 16	15 .. 08	07 .. 00
0	Descriptor Control	Descriptor Type	Descriptor Length	
1	MSB			
2	T10 Vendor ID			
3	MSB			
..	Vendor Specific			
N	LSB			

**T10 Vendor ID:** Shall be set to the Vendor's T10 Vendor ID.

#### 4.3.38.3 EVFP\_COMMIT Message Payload

Both EVFP\_COMMIT Request and EVFP\_COMMIT Accept have no Message Payload.

### 4.3.39 Link Keep Alive (LKA)

#### 4.3.39.1 Overview

The LKA ELS is used for traffic generation. It provides a means to generate traffic in order to confirm that the link is still intact and/or to ensure the link is not terminated due to lack of traffic. The LKA ELS was specifically designed to keep Fibre Channel backbone links alive (e.g., some TCP implementations will disconnect connections that are not used for some time period).

The LKA ELS is sent by a VE\_Port or B\_Access portal (see FC-BB-5) to a remote peer in order to determine the health of a link between them, or simply to generate traffic to keep a link from being terminated. If a link is comprised of more than one physical or virtual connection, the LKA may be transmitted on each of the connections. If a connection is configured to handle only specific class(es) of traffic, the LKA shall be sent on a class of service the connection is configured for.

The LKA ELS request Sequence shall consist of a single frame requesting the recipient to reply using the ACC reply Sequence consisting of a single frame. The LKA ELS request frame shall indicate End\_Sequence and Sequence Initiative transfer as well as other appropriate F\_CTL bits as defined in FC-FS-2. The LKA ELS shall be transmitted as a single frame Sequence and the ACC reply Sequence is also a single frame Sequence. The LKA ELS shall be transmitted as an Exchange that is separate from any other Exchange. The LKA ELS is applicable to Class F, 2, and 3.

The LKA ELS may be sent at any time. The LKA ELS should be sent at least every K\_A\_TOV if no traffic has been sent and/or received on the connection. The default value for K\_A\_TOV shall be 1/2 E\_D\_TOV.

If an accept is not received within E\_D\_TOV, a new LKA ELS may be transmitted in a new Exchange. The Exchange used for the previous LKA request shall be aborted.

Upon discovering an error (e.g. due to service reject or failure to receive a timely accept in response to one or more LKA ELS requests), the initiator shall initiate appropriate exception handling. The definition of appropriate exception handling is topology-specific.

#### 4.3.39.2 Protocol

- a) Link Keep Alive request Sequence; and
- b) LS\_ACC or LS\_RJT reply Sequence.

#### 4.3.39.3 Request Sequence

**Addressing:** The S\_ID field shall be set to FFFFFDh, indicating the Fabric Controller of the VE\_Port or B\_Access portal originating the request. The D\_ID field shall be set to FFFFFDh, indicating the Fabric Controller of the remote peer.

**Payload:** The format of the LKA Request Payload is shown in table 131.

**Table 131 – LKA Payload**

Bits Word	31... 24	23... 16	15... 08	07... 00
0	80h	00h	00h	00h

#### 4.3.39.4 Reply Sequence

**LS\_RJT:** LS\_RJT signifies rejection of the LKA request.

**LS\_ACC:** LS\_ACC signifies that the connection is intact. The format of the LS\_ACC payload is shown in table 132.

**Table 132 – LKA LS\_ACC Payload**

Bits Word	31... 24	23... 16	15... 08	07... 00
0	02h	00h	00h	00h

#### 4.3.40 Link Cable Beacon (LCB)

The LCB ELS is used to turn on and turn off a beacon (e.g., a LED) that is associated with the connector of the receiving port. It provides a means to visually locate the corresponding end of a specific link and, therefore, may not be affected by the state of the attached link or transitions in the state of the attached link.

The LCB ELS is transmitted by:

- a) an N\_Port to the F\_Port Controller of the attached F\_Port;
- b) an F\_Port to an attached N\_Port; or
- c) an N\_Port to an N\_Port in a point-to-point topology.

##### 4.3.40.1 Protocol

- a) Link Cable Beacon request Sequence; and
- b) LS\_ACC or LS\_RJT reply Sequence.

##### 4.3.40.2 Request Sequence

**Addressing:** For an N\_Port, the S\_ID field shall be set to the address identifier of the originating N\_Port. The D\_ID field shall be set to FFFFEEh, indicating the F\_Port Controller of the destination F\_Port, or to the address identifier of the destination N\_Port. For an F\_Port, the S\_ID field shall be set to FFFFEEh, indicating the F\_Port Controller of the originating F\_Port. The D\_ID field shall be set to the address identifier of the destination N\_Port.

**Payload:** The format of the LCB Request Payload is shown in table 133.

**Table 133 – LCB Payload**

Bits Word	31 .. 24	23 .. 16	15 .. 08	07 .. 00
0	81h	00h	00h	00h
1	Subcommand	Reserved		Capability
2	Status	Frequency	Duration	

**Subcommand:** The subcommand field functions are specified in table 134.

**Table 134 – Subcommand field functions**

Functions	Value
Reserved	0
Beacon on	1
Beacon off	2
Reserved	3 - 255

The status, capability, frequency, and duration fields are only applicable for the Beacon on subcommand and the response to the Beacon on subcommand.

**Capability:** The capability field functions are specified in table 135. The capability field indicates the functions supported by the requesting N\_Port or F\_Port.

**Table 135 – Capability field functions**

Bits	Description
2 - 7	Reserved
1	Frequency Supported: 0 = Support not indicated. 1 = N_Port or F_Port supports specific frequency selections.
0	Duration Supported: 0 = Support not indicated. 1 = N_Port or F_Port supports specific duration selections.

**Status:** The status field functions are specified in table 136.

**Table 136 – Status field functions**

Functions	Value
Reserved	0
Normal	1
Warning	2
Critical	3
Reserved	4 - 255

**Frequency:** The frequency field specifies the number of blinks in a 10 second interval. A frequency field value of zero specifies the beacon is always on.



**Duration:** The duration field specifies the duration, in seconds, that the subcommand function shall operate (e.g., beaconing is on at the specified frequency). A duration field value of zero specifies the subcommand function shall operate (e.g., continue beaconing at the specified frequency) until a beacon off subcommand is received.

#### 4.3.40.3 Reply Sequence

**LS\_RJT:** LS\_RJT signifies rejection of the LCB request.

**LS\_ACC:** LS\_ACC signifies acceptance of the LCB request. The format of the LS\_ACC Payload is found in table 137.

**Table 137 – LCB LS\_ACC Payload**

Bits Word	31 .. 24	23 .. 16	15 .. 08	07 .. 00
0	02h	00h	00h	00h
1	Subcommand	Reserved		Capability
2	Status	Frequency	Duration	

The values of the fields of the response payload shall be the same as those in the request payload unless otherwise indicated by the Capability field.

The Capability field indicates the functions supported by the receiving N\_Port or F\_Port as follows:

- If frequency is supported then the Frequency Supported flag shall be set to one and the Frequency field shall be set to the value requested or the nominally supported value (i.e. an implementation is not required to support the exact Frequency value provided in the request);
- if frequency is not supported then the Frequency Supported flag shall be set to zero and the Frequency field should be set to the value in the request;
- if duration is supported then the Duration Supported flag shall be set to one and the Duration field shall be set to the value requested or the nominally supported value (i.e. an implementation is not required to support the exact Duration value provided in the request); or
- if duration is not supported then the Duration Supported flag shall be set to zero and the Duration field should be set to the value in the request.

#### 4.3.41 Registered Fabric Change Notification (RFCN)

##### 4.3.41.1 Overview

The Registered Fabric Change Notification (RFCN) ELS allows the Fabric Controller to notify an N\_Port\_ID of relevant changes in selected Fabric-wide policies (see FC-SP-2). RFCN is a unidirectional ELS (i.e., it has no reply Sequence).

If a Fabric detects an upcoming change in a security attribute for which change notification has been registered, the Fabric Controller shall send the RFCN ELS to the N\_Port\_IDs registered for change notification for that security attribute. The RFCN ELS shall not be sent to an N\_Port\_ID unless the N\_Port\_ID has registered for change notification of a security attribute, and the attribute is changing.

#### 4.3.41.2 RFCN Request Sequence

**Protocol:** Registered Fabric Change Notification (RFCN) Request Sequence

**Addressing:** The S\_ID designates the Fabric Controller (FFFFFFDh). The D\_ID field designates the recipient N\_Port\_ID that is being notified of the change in the Fabric.

**Payload:** The format of the RFCN request payload is shown in table 138.

**Table 138 – RFCN Request Payload**

Item	Size (Bytes)
9700 0000h	4
Change Flags	4

**Change Flags:** The defined Change Flags are shown in table 139.

**Table 139 – Change Flags**

Bit	Description
31 .. 1	Reserved
0	<b>Fabric Security Attributes:</b> If set to one, a change is occurring in a Fabric Security Attribute (e.g., the Fabric Binding or the Insistent Domain_ID Attributes) for which change notification has been registered (see FC-SP-2). If set to zero, the Fabric Security Attributes for which change notification is registered are not changing.

#### 4.3.41.3 RFCN Reply Sequence

None.

#### 4.3.42 Define FFI Domain Topology Map (FFI\_DTM)

##### 4.3.42.1 Description

The FFI\_DTM ELS Request shall transfer a complete initial or replacement Domain Topology Map to the Domain Controller of the AE Principal Switch.

Support for this ELS is mandatory for a Domain Controller in an AE Principal Switch or an AE Switch that is capable of becoming an AE Principal Switch. Support for this ELS is optional for Nx\_Ports.

If the Domain Controller that receives an FFI\_DTM request currently is not the AE Principal Switch, it shall respond with an LS\_RJT reply with a reason code of "Logical error".

If a destination receives this ELS Request that is not a Domain Controller, it shall respond with an LS\_RJT reply with a reason code of "Command not supported".

##### 4.3.42.2 Protocol

- a) FFI Domain Topology Map Request Sequence; and
- b) LS\_ACC or LS\_RJT Reply Sequence.

**4.3.42.3 Request Sequence**

**Addressing:** The S\_ID designates the Nx\_Port sending an FFI Domain Topology Map. The D\_ID designates the Domain Controller of the AE Principal Switch in the form FFFCxxh, where xx is the one-byte value assigned to the Domain Controller.

**Payload:** The format of the FFI\_DTM Request Payload is shown in table 140.

**Table 140 – FFI\_DTM Payload**

Bits Word	31 .. 24	23 .. 16	15 .. 08	07 .. 00
0	A0h	00h	Payload Length	
1	FFI Incarnation Number			
2	Reserved	Reserved	Number of FFI Link State Records	
3	MSB			
..	FFI Link State Records			
n	LSB			

**Payload Length:** This field is the length in bytes of the entire Payload, inclusive of the length of word 0. This value shall be a multiple of 4. The minimum value of this field is 28. The maximum value of this field is 65 532.

**FFI Incarnation Number:** This field contains the new incarnation of the FFI Domain Topology Map.

**Number of FFI Link State Records:** This field shall specify the number of FFI Link State Records that follow this field. The minimum value is 2.

**FFI Link State Records:** This field contains all of the individual FFI Link State Records that describe the Domain Topology Map of the Avionics Fabric. The format of the FFI Link State Record is described in FC-SW-4.

**4.3.42.4 Reply Sequence**

**LS\_RJT:** LS\_RJT signifies the rejection of the FFI\_DTM Request. The LS\_RJT reply contains an appropriate reject reason code.

**LS\_ACC:** LS\_ACC signifies acceptance of the FFI\_DTM Request. The format of the LS\_ACC Payload for FFI\_DTM is shown in table 141.

**Table 141 – FFI\_DTM LS\_ACC Payload**

Bits Word	31 .. 24	23 .. 16	15 .. 08	07 .. 00
0	02h	00h	00h	00h

**4.3.43 Request FFI Domain Topology Map (FFI\_RTM)**

**4.3.43.1 Description**

The FFI\_RTM ELS Request shall request the Domain Controller of the AE Principal Switch to return the current Domain Topology Map in the LS\_ACC Reply Sequence.

Support for this ELS is mandatory for a Domain Controller in an AE Principal Switch or an AE Switch that is capable of becoming an AE Principal Switch. Support for this ELS is optional for Nx\_Ports.

If the Domain Controller that receives an FFI\_RTM request currently is not the AE Principal Switch, it shall respond with an LS\_RJT reply with a reason code of "Logical error".

If a destination receives this ELS Request that is not a Domain Controller, it shall respond with an LS\_RJT reply with a reason code of "Command not supported."

**4.3.43.2 Protocol**

- a) FFI Domain Topology Map Request Sequence; and
- b) LS\_ACC or LS\_RJT Reply Sequence.

**4.3.43.3 Request Sequence**

**Addressing:** The S\_ID field value identifies the Nx\_Port requesting the Domain Topology Map from the Domain Controller of the AE Principal Switch. The D\_ID designates the Domain Controller of the AE Principal Switch in the form FFFCxxh, where xx is the one-byte value assigned to the Domain Controller.

**Payload:** The format of the FFI\_RTM Request Payload is shown in table 142.

**Table 142 – FFI\_RTM Payload**

Bits Word	31 .. 24	23 .. 16	15 .. 08	07 .. 00
0	A1h	00h	00h	00h

**4.3.43.4 Reply Sequence**

**LS\_RJT:** LS\_RJT signifies the rejection of the FFI\_RTM Request. The LS\_RJT reply contains an appropriate reject reason code.

**LS\_ACC:** LS\_ACC signifies acceptance of a valid FFI\_RTM Request and that the AE Principal Switch has transmitted the requested data. The format of the LS\_ACC Payload for FFI\_RTM is shown in table 143.

**Table 143 – FFI\_RTM LS\_ACC Payload**

Bits Word	31 .. 24	23 .. 16	15 .. 08	07 .. 00
0	02h	00h	Payload Length	
1	FFI Incarnation Number			
2	Reserved	Reserved	Number of FFI Link State Records	
3	MSB			
..	FFI Link State Records			
n	LSB			

**Payload Length:** This field is the length in bytes of the entire Payload, inclusive of the length of word 0. This value shall be a multiple of 4 bytes. The minimum value of this field is 28 bytes. The maximum value of this field is 65 532.

**FFI Incarnation Number:** This field contains the current incarnation of the FFI Domain Topology Map.

**Number of FFI Link State Records:** This field shall specify the number of FFI Link State Records that follow this field. The minimum value is 2.

**FFI Link State Records:** This field contains all of the individual FFI Link State Records that describe the Domain Topology Map of the Avionics Fabric. The format of the FFI Link State Record is described in FC-SW-4.

#### 4.3.44 FFI AE Principal Switch Selector (FFI\_PSS)

##### 4.3.44.1 Description

The FFI\_PSS ELS Request shall be sent to an AE Switch that is not currently the AE Principal Switch in order to command the recipient to become the AE Principal Switch.

Support for this ELS is mandatory for a Domain Controller in an AE Principal Switch or an AE Switch that is capable of becoming an AE Principal Switch. Support for this ELS is optional for Nx\_Ports.

If the Domain Controller that receives an FFI\_PSS request currently is the AE Principal Switch or is not capable of becoming the AE Principal Switch, it shall respond with an LS\_RJT reply with a reason code of "Logical error".

If a destination receives this ELS Request that is not a Domain Controller, it shall respond with an LS\_RJT reply with a reason code of "Command not supported".

##### 4.3.44.2 Protocol

- a) FFI AE Principal Switch Selector Request Sequence; and
- b) LS\_ACC or LS\_RJT Reply Sequence.

#### 4.3.44.3 Request Sequence

**Addressing:** The S\_ID field value identifies the Nx\_Port requesting a change of AE Principal Switch. The D\_ID field value identifies the Domain Controller of an AE Switch that is not the current AE Principal Switch but is capable of becoming an AE Principal Switch in the form FFFCxxh, where xx is the one-byte value assigned to the Domain Controller.

**Payload:** The format of the FFI\_PSS Request Payload is shown in table 144.

**Table 144 – FFI\_PSS Payload**

Bits Word	31 .. 24	23 .. 16	15 .. 08	07 .. 00
0	A2h	00h	00h	00h

#### 4.3.44.4 Reply Sequence

**LS\_RJT:** LS\_RJT signifies the rejection of the FFI\_PSS Request. The LS\_RJT reply contains an appropriate reject reason code.

**LS\_ACC:** LS\_ACC signifies acceptance of the FFI\_PSS Request. The format of the LS\_ACC Payload for FFI\_PSS is shown in table 145.

**Table 145 – FFI\_PSS LS\_ACC Payload**

Bits Word	31 .. 24	23 .. 16	15 .. 08	07 .. 00
0	02h	00h	00h	00h

#### 4.3.45 FFI Map Update Registration (FFI\_MUR)

##### 4.3.45.1 Description

The FFI\_MUR ELS Request shall request the Domain Controller of the AE Principal Switch to add or remove the Nx\_Port that is sending the FFI\_MUR Request (S\_ID value) to/from the list of Nx\_Ports registered to receive the FFI\_RMUN ELS Requests (see 4.3.46).

Support for this ELS is mandatory for a Domain Controller in an AE Principal Switch or an AE Switch that is capable of becoming an AE Principal switch. Support for this ELS is optional for Nx\_Ports.

If the Domain Controller that receives an FFI\_MUR request currently is not the AE Principal Switch, it shall respond with an LS\_RJT reply with a reason code of "Logical error".

If a destination receives this ELS Request that is not a Domain Controller, it shall respond with an LS\_RJT reply with a reason code of "Command not supported".

##### 4.3.45.2 Protocol

- a) FFI Map Update Registration Request Sequence; and
- b) LS\_ACC or LS\_RJT Reply Sequence.

### 4.3.45.3 Request Sequence

**Addressing:** The S\_ID designates the Nx\_Port requesting registration for FFI Map Update Notification. The D\_ID designates the Domain Controller of the AE Principal Switch in the form FFFCxxh, where xx is the one-byte value assigned to the Domain Controller.

**Payload:** The format of the FFI\_MUR Request Payload is shown in table 146.

**Table 146 – FFI\_MUR Payload**

Bits Word	31 .. 24	23 .. 16	15 .. 08	07 .. 00
0	A3h	00h	00h	00h
1	00h	00h	00h	Registration Function

**Registration Function:** The format of the Registration Function field is shown in table 147.

**Table 147 – Registration Function**

Function	Value
Reserved	0
Full registration - Register to receive FFI_RMUN Requests. If the requesting Nx_Port is already registered, this request is treated as a NOP function.	3
Reserved	4 - 254
Clear registration – Remove the current FFI_RMUN registration, if any. If the requesting Nx_Port is not registered, this request is treated as a NOP function.	255

### 4.3.45.4 Reply Sequence

**LS\_RJT:** LS\_RJT signifies the rejection of the FFI\_MUR Request. The LS\_RJT reply contains an appropriate reject reason code.

**LS\_ACC:** LS\_ACC signifies acceptance of the FFI\_MUR Request and registration to receive FFI\_RMUN Requests. The format of the LS\_ACC Payload for FFI\_MUR is shown in table 148.

**Table 148 – FFI\_MUR LS\_ACC Payload**

Bits Word	31 .. 24	23 .. 16	15 .. 08	07 .. 00
0	02h	00h	00h	00h

**4.3.46 FFI Registered Map Update Notification (FFI\_RMUN)**

**4.3.46.1 Description**

A unidirectional FFI\_RMUN Request shall be sent to registered Nx\_Ports (see 4.3.45) after the AE Principal Switch sends a Fast Fabric Initialization (FFI) Request Sequence initiated by the AE Principal Switch.

Support for this ELS is mandatory for a Domain Controller in an AE Principal Switch or an AE Switch that is capable of becoming an AE Principal Switch. Support for this ELS is optional for Nx\_Ports. However, if the Nx\_Port invokes the FFI\_MUR ELS, it shall support receipt of the FFI\_RMUN Request.

FFI\_RMUN Request is intended to provide a timely indication of Map Updates to avoid the considerable time to discover any such failure.

Sending FFI\_RMUN Requests between Nx\_Ports is prohibited. Sending FFI\_RMUN Requests by a Domain Controller that is not an AE Principal Switch is prohibited.

**4.3.46.2 Registration to Receive FFI\_RMUN Requests**

See 4.3.45.

**4.3.46.3 Protocol**

- a) FFI\_RMUN Request Sequence.

**4.3.46.4 Request Sequence**

**Addressing:** The S\_ID is the Domain Controller of the AE Principal Switch (FFFCxxh) and the D\_ID is the address of the Registered Nx\_Port destination.

**Payload:** The format of the FFI\_RMUN Request Payload is shown in table 149.

**Table 149 – FFI\_RMUN Payload**

Bits Word	31 .. 24	23 .. 16	15 .. 08	07 .. 00
0	A4h	00h	Payload Length	
1	FFI Incarnation Number			
2	Reserved	Reserved	Number of FFI Link State Records	
3	MSB			
..	FFI Link State Records			
n	LSB			

**Payload Length:** This field is the length in bytes of the entire Payload, inclusive of the length of word 0. This value shall be a multiple of 4 bytes. The minimum value of this field is 28 bytes. The maximum value of this field is 65 532.

**FFI Incarnation Number:** This field contains the current incarnation of the FFI Domain Topology Map.



**Number of FFI Link State Records:** This field shall specify the number of FFI Link State Records that follow this field. The minimum value is 2.

**FFI Link State Records:** This field contains all of the individual FFI Link State Records that describe the Domain Topology Map of the Avionics Fabric. The format of the FFI Link State Record is described in FC-SW-4.

**4.3.46.5 Reply Sequence**

**LS\_RJT:** none

**LS\_ACC:** none

**4.3.47 FFI Suspend Map Updates (FFI\_SMU)**

**4.3.47.1 Description**

The FFI\_SMU ELS Request shall request the Domain Controller of the AE Principal Switch, to suspend Domain Topology Map updates as specified in FC-SW-4. If Domain Topology Map updates are currently suspended, this request is treated as a NOP function. Successful execution of this ELS shall also suspend Registered Map Updates Notifications, if any (see 4.3.46).

Support for this ELS is mandatory for a Domain Controller in an AE Principal Switch or an AE Switch that is capable of becoming an AE Principal switch. Support for this ELS is optional for Nx\_Ports.

If the Domain Controller that receives an FFI\_SMU request currently is not the AE Principal Switch, it shall respond with an LS\_RJT reply with a reason code of "Logical error".

If a destination receives this ELS Request that is not a Domain Controller, it shall respond with an LS\_RJT reply with a reason code of "Command not supported".

**4.3.47.2 Protocol**

- a) FFI Suspend Map Updates Request Sequence; and
- b) LS\_ACC or LS\_RJT Reply Sequence.

**4.3.47.3 Request Sequence**

**Addressing:** The S\_ID field value identifies the Nx\_Port requesting suspension of Domain Topology Map updates by the Domain Controller of the AE Principal Switch. The D\_ID field value identifies the Domain Controller of the AE Principal Switch in the form FFFCxxh, where xx is the one-byte value assigned to the Domain Controller.

**Payload:** The format of the FFI\_SMU Request Payload is shown in table 150.

**Table 150 – FFI\_SMU Payload**

Bits Word	31 .. 24	23 .. 16	15 .. 08	07 .. 00
0	A5h	00h	00h	00h

**4.3.47.4 Reply Sequence**

**LS\_RJT:** LS\_RJT signifies the rejection of the FFI\_SMU Request. The LS\_RJT reply contains an appropriate reject reason code.

**LS\_ACC:** LS\_ACC signifies acceptance of a valid FFI\_SMU Request and indicates that the Domain Controller of the AE Principal Switch has suspended Domain Topology Map updates. The format of the LS\_ACC Payload for FFI\_SMU is shown in table 151.

**Table 151 – FFI\_SMU LS\_ACC Payload**

Bits Word	31 .. 24	23 .. 16	15 .. 08	07 .. 00
0	02h	00h	00h	00h

**4.3.48 FFI Resume Map Updates (FFI\_RMU)**

**4.3.48.1 Description**

The FFI\_RMU ELS Request shall request the Domain Controller of the AE Principal Switch, to resume Domain Topology Map updates as specified in FC-SW-4. If Domain Topology Map updates are currently not suspended, this request is treated as a NOP function. Successful execution of this ELS shall also resume Registered Map Updates Notifications, if any (see 4.3.46).

Support for this ELS is mandatory for a Domain Controller in an AE Principal Switch or an AE Switch that is capable of becoming an AE Principal Switch. Support for this ELS is optional for Nx\_Ports.

If the Domain Controller that receives an FFI\_RMU request currently is not the AE Principal Switch, it shall respond with an LS\_RJT reply with a reason code of “Logical error”.

If a destination receives this ELS Request that is not a Domain Controller, it shall respond with an LS\_RJT reply with a reason code of “Command not supported”.

**4.3.48.2 Protocol**

- a) FFI Resume Map Updates Request Sequence; and
- b) LS\_ACC or LS\_RJT Reply Sequence.

**4.3.48.3 Request Sequence**

**Addressing:** The S\_ID field value identifies the Nx\_Port requesting resumption of Domain Topology Map updates by the Domain Controller of the AE Principal Switch. The D\_ID field value identifies the Domain Controller of the AE Principal Switch in the form FFCxxh, where xx is the one-byte value assigned to the Domain Controller.

**Payload:** The format of the FFI\_RMU Request Payload is shown in table 152.

**Table 152 – FFI\_RMU Payload**

Bits Word	31 .. 24	23 .. 16	15 .. 08	07 .. 00
0	A6h	00h	00h	00h

**4.3.48.4 Reply Sequence**

**LS\_RJT:** LS\_RJT signifies the rejection of the FFI\_RMU Request. The LS\_RJT reply contains an appropriate reject reason code.

**LS\_ACC:** LS\_ACC signifies acceptance of a valid FFI\_RMU Request and indicates that the Domain Controller of the AE Principal Switch has resumed Domain Topology Map updates. The format of the LS\_ACC Payload for FFI\_RMU is shown in table 153.

**Table 153 – FFI\_RMU LS\_ACC Payload**

Bits Word	31 .. 24	23 .. 16	15 .. 08	07 .. 00
0	02h	00h	00h	00h

**4.3.49 Read Diagnostic Parameters (RDP)**

**4.3.49.1 Description**

The RDP ELS requests an FC\_Port to return the identified diagnostic parameters associated with the N\_Port\_ID specified in the Payload. This provides the Nx\_Port transmitting the request with information that may be used for diagnosis of link or port related errors, or degraded conditions associated with the designated FC\_Port.

**4.3.49.2 Protocol**

- a) Read Diagnostic Parameters Request Sequence; and
- b) LS\_ACC or LS\_RJT Reply Sequence

**4.3.49.3 Request Sequence**

**Addressing:** The S\_ID field designates the source Nx\_Port requesting the diagnostic parameters. The D\_ID field shall be set as follows:

- a) to any Domain Controller (FFFCxxh);
- b) to the F\_Port Controller (FFFFEh); or
- c) to any Nx\_Port N\_Port\_ID

**Payload:** The format of the RDP Request Payload is shown in table 154.

**Table 154 – RDP Payload**

Bits Word	31 .. 24	23 .. 16	15 .. 08	07 .. 00
0	RDP (18h)	00h	00h	00h
1	Descriptor List Length = 12			
2	MSB			
3	N_Port_ID Descriptor			
4	LSB			

**N\_Port\_ID Descriptor:** See 4.2.4.3. The requested diagnostic parameters are described as follows:

- a) if the D\_ID is a Domain Controller well known address (FFFCxxh), the N\_Port\_ID in the N\_Port\_ID descriptor shall be set to an N\_Port\_ID within the associated domain. The diagnostic parameters requested are for the Fx\_Port through which the N\_Port\_ID is logged in;
- b) if the D\_ID is the F\_Port Controller Well-known address (FFFFFFEh), the N\_Port\_ID in the N\_Port\_ID descriptor shall be set to the S\_ID of the request. The diagnostic parameters requested are for the Fx\_Port through which the N\_Port\_ID is logged in; or
- c) for all other D\_IDs, the N\_Port\_ID in the N\_Port\_ID descriptor shall be set to the D\_ID of the request. The diagnostic parameters requested are for Nx\_Port to which the D\_ID is assigned.

#### 4.3.49.4 Reply Sequence

If the Nx\_Port receiving an RDP ELS request is not logged in with the source N\_Port, it shall respond with LS\_RJT with a reason code of “Login Required” or respond with a single frame sequence as appropriate for the ELS and the current state of the Nx\_Port.”

LS\_RJT: LS\_RJT signifies rejection of the RDP command. The LS\_RJT reason code and reason code explanation are set as follows:

- a) If an FC\_Port does not support the RDP request, it shall reply with an LS\_RJT specifying a reason code of “Command not supported” (i.e., 0Bh) and a reason code explanation of “Request not supported” (i.e., 2Ch);
- b) if the N\_Port\_ID in the N\_Port\_ID descriptor is not logged in with an F\_Port within the domain, the Domain Controller shall reply with an LS\_RJT specifying a reason code of “Logical error” (i.e., 03h) and reason code explanation “Invalid N\_Port\_ID” (i.e., 1Fh); or
- c) if the FC\_Port receiving an RDP ELS request requires a login with the source FC\_Port and is not logged in, it shall reply with an LS\_RJT specifying a reason code of “Unable to perform command request” (i.e., 09h) and a reason code explanation of “N\_Port Login required” (i.e., 1Eh).

**LS\_ACC:** LS\_ACC signifies that the FC\_Port has transmitted the requested data.

An FC\_Port sending an RDP ELS prior to login implies the originator has a Receive Data\_Field size capable of receiving the maximum length of the response. If the FC\_Port receiving an RDP ELS request does not require a login and is not logged in with the source FC\_Port it shall:

- 1) respond with a single frame Sequence with a payload that fits within the implied Receive Data\_Field size; or
- 2) respond with a multi-frame Sequence using the default login value for Receive Data\_Field size.

The format of the LS\_ACC Payload is shown in 155.

**Table 155 – RDP LS\_ACC Payload**

Bits Word	31 .. 24	23 .. 16	15 .. 08	07 .. 00
0	LS_ACC (02h)	00	00	00
1	Descriptor list length ((n-1)*4) bytes)			
2	MSB			
3	Link Service Request Information descriptor (see 4.2.4.2)			
4	LSB			
5 - n	Diagnostic parameter descriptors			

The descriptor list length shall not be greater than 2040-bytes (i.e. n is less than or equal to 511).

The diagnostic parameter descriptors (see 4.3.49.5) in an RDP LS\_ACC shall include;

- a) a Link Service Request Information descriptor;
- b) a Port Speed descriptor;
- c) a Link Error Status Block descriptor; and
- d) a Port Names descriptor for the Fx\_Port or Nx\_Port for which diagnostic parameters are being provided followed by a Port Names descriptor for the directly attached Fx\_Port or Nx\_Port, if any.

The diagnostic parameter descriptors in an RDP LS\_ACC shall also include one of the following descriptors;

- a) an SFP Diagnostics descriptor; or
- b) a QSFP Diagnostics descriptor.

The diagnostic parameter descriptors in an RDP LS\_ACC may include one or more of the following descriptors;

- a) a FEC Status descriptor;
- b) a Buffer Credit descriptor;
- c) one or more Optical Element Data descriptors; or
- d) an Optical Product Data descriptor.

**4.3.49.5 Diagnostic parameter descriptors**

**4.3.49.5.1 Port Speed Descriptor**

The Port Speed descriptor is shown in table 156.

**Table 156 – Port Speed Descriptor**

Bits Word	31 .. 24	23 .. 16	15 .. 08	07 .. 00
0	Port Speed Descriptor tag = 0001 0001h			
1	Port Speed Descriptor Length (4 bytes)			
2	Port Speed Capabilities		Port Operating Speed	

Port Speed Capabilities and Port Operating Speed are as defined for the RPSC ELS (see 4.3.36). The Phy Type is specified in the Link Error Status Block descriptor (see 4.3.49.5.2).

**4.3.49.5.2 Link Error Status Block Descriptor**

The Link Error Status Block Descriptor is shown in table 157.

**Table 157 – Link Error Status Block Descriptor**

Bits Word	31 .. 24	23 .. 16	15 .. 08	07 .. 00
0	Link Error Status Block Descriptor tag = 0001 0002h			
1	Link Error Status Block Descriptor Length (28 bytes)			
2	MSB			
3				
4	Link Error Status Block (see FC-FS-4 or FC-			
5	BB-6)			
6				
7	LSB			
8	PN_Port Phy Type	Reserved		

The content of the Link Error Status Block is specified in FC-FS-4 or FC-BB-6, depending on the PN\_Port Phy Type.

**PN\_Port Phy Type:** Word 8bits 31 - 30 identify the type of physical interface for the PN\_Port or PF\_Port through which the RDP request was received (see table 158). Bits 29 - 24 of this field are reserved.

**Table 158 – VN\_Port Phy Type**

Encoded Value Word 1, Bits 15 - 14	Description
00b	No Information about Phy Type Provided.
01b	The sending VN_Port uses an FC-FS-3 PN_Port or PF_Port.
10b	The sending VN_Port uses a lossless Ethernet MAC.
11b	Reserved

**4.3.49.5.3 Port Names Descriptor**

The Port Names Descriptor contains the Node WWN and the FC\_Port WWN for the FC\_Port as shown in table 159. If describing a VN\_Port, the Node WWN and FC\_Port WWN fields contain the names associated with the VN\_Port.

**Table 159 – Port Names Descriptor**

Bits Word	31 .. 24	23 .. 16	15 .. 08	07 .. 00
0	Port Names Descriptor tag = 0001 0003h			
1	Port Names Descriptor Length (16 bytes)			
2	MSB			
3	Node WWN			LSB
4	MSB			
5	Port WWN			LSB

**4.3.49.5.4 SFP Diagnostic Parameters descriptor**

The SFP Diagnostic Parameters descriptor is shown in table 160.

**Table 160 – SFP Diagnostic Parameters descriptor**

Bits Word	31 .. 24	23 .. 16	15 .. 08	07 .. 00
0	SFP Diagnostics descriptor tag = 0001 0000h			
1	SFP Diagnostics descriptor Length (12 bytes)			
2	Temperature		Vcc	
3	Tx Bias		Tx Power	
4	Rx Power		SFP Flags	

SFP diagnostic parameters are as provided in Diagnostic Monitoring Interface for Optical Transceivers (see SFF-8472). Parameters provided are;

- a) **Temperature:** The temperature field contains the internally measured transceiver temperature in units of 1/256 C, range -128C to + 128C;
- b) **Vcc:** The Vcc field contains internally measured supply voltage in units of 100uV, range 0 - 6.55V;
- c) **Tx Bias:** The Tx Bias field contains the measured transmitter laser bias current in units of 2 uA, Range 0 - 131mA;
- d) **Tx Power:** The Tx Power field contains the measured coupled TX output power in units of 0.1 uW, range 0 - 6.5mW;
- e) **Rx Power:** The Rx Power field contains the measured received optical power in units of 0.1 uW, range 0 - 6.5mW; and



f) **SFP Flags:** The defined SFP Flags are show in table 161.

**Table 161 – SFP Flags**

Bit	Description
15	FEC Active: 0b = 16G FEC status is inactive or unknown 1b = 16G FEC is active
14 - 8	Reserved
7 - 6	Connector Type: 00b = Other or unknown 01b = SFP+ 10b - 11b = reserved
5	SFP Diagnostic Parameters not valid: If set to 1, the response does not include valid values for; a) Temperature;  b) Vcc;  c) Tx Bias;  d) Tx Power; and  e) Rx Power.
4	Optical Port: If set to 1, the FC_Port is an optical port. If set to 0, the FC_Port is not an optical port.
3 - 0	Port Tx Type: 0000b = Other or unknown 0001b = Short Wave Laser 0010b = Long Wave Laser LC 1310nm 0011b = Long Wave Laser LL 1550nm 0100b - 1111b = reserved

SFP diagnostic parameters may be periodically obtained from an SFP by the FC\_Port and parameters returned shall be the most recent values obtained. If the recipient of the RDP request is not able to provide diagnostic parameters, the values in these parameters shall be set to 0 and the SFP Diagnostic Parameters not Valid bit 5 shall be set to 1.

#### 4.3.49.5.5 QSFP Diagnostic Parameters descriptor

The QSFP Diagnostic Parameters descriptor is shown in table 162.

**Table 162 – QSFP Diagnostic Parameters descriptor**

Bits Word	31 .. 24	23 .. 16	15 .. 08	07 .. 00
0	QSFP Diagnostics descriptor tag = 0001 0004h			
1	QSFP Diagnostics descriptor Length (40 bytes)			
2	Temperature		Vcc	
3	Reserved		QSFP Flags	
4	Lane 0 – Tx Bias		Lane 0 – Tx Power	
5	Lane 0 – Rx Power		Reserved	
6	Lane 1 – Tx Bias		Lane 1 – Tx Power	
7	Lane 1 – Rx Power		Reserved	
8	Lane 2 – Tx Bias		Lane 2 – Tx Power	
9	Lane 2 – Rx Power		Reserved	
10	Lane 3 – Tx Bias		Lane 3 – Tx Power	
11	Lane 3 – Rx Power		Reserved	

QSFP diagnostic parameters are as provided in Common Management Interface (see SFF-8636). Parameters provided are;

- a) Temperature: The temperature field contains the internally measured transceiver temperature in units of 1/256 C, range -128C to + 128C;
- b) Vcc: The Vcc field contains internally measured supply voltage in units of 100uV, range 0 - 6.55V;
- c) Tx Bias: The Tx Bias fields contains the measured transmitter laser bias current in units of 2 uA, Range 0 - 131mA for each corresponding QSFP lane;
- d) Tx Power: The Tx Power fields contains the measured coupled TX output power in units of 0.1 uW, range 0 - 6.5mW for each corresponding QSFP lane;
- e) Rx Power: The Rx Power fields contains the measured received optical power in units of 0.1 uW, range 0 - 6.5mW for each corresponding QSFP lane; and

f) QSFP Flags: The defined QSFP Flags are show in table 163.

**Table 163 – QSFP Flags**

Bits	Description
15	FEC Active: 0b = 16G FEC status is inactive or unknown 1b = 16G FEC is active
14 – 11	Reserved
10 – 9	Lane Identifier: 00b = Lane 0 01b = Lane 1 10b = Lane 2 11b = Lane 3
8	Lane Identifier Valid: If set to 1, the response is for the single lane indicated by the Lane Identifier. If set to 0, the Lane Identifier is not meaningful.
7 – 6	Connector Type: 00b = Other or unknown 01b = QSFP 10b - 11b = reserved
5	QSFP Diagnostic Parameters not valid: If set to 1, the response does not include valid values for; a) Temperature;  b) Vcc;  c) Tx Bias for any lane;  d) Tx Power for any lane; and  e) Rx Power for any lane.
4	Optical Port: If set to 1, the FC_Port is an optical port. If set to 0, the FC_Port is not an optical port.
3 – 0	Port Tx Type: 0000b = Other or unknown 0001b = Short Wave Laser 0010b = Long Wave Laser 0100b - 1111b = reserved

QSFP diagnostic parameters may be periodically obtained from an QSFP by the FC\_Port and parameters returned shall be the most recent values obtained. If the recipient of the RDP request is not able to provide diagnostic parameters, the values in these parameters shall be set to 0 and the QSFP Diagnostic Parameters not Valid bit 5 shall be set to 1.

#### 4.3.49.5.6 FEC Status descriptor

The FEC Status descriptor is shown in table 164.

**Table 164 – FEC Status Descriptor**

Bits Word	31 .. 24	23 .. 16	15 .. 08	07 .. 00
0	FEC Status Descriptor tag = 0001 0005h			
1	FEC Status Descriptor Length (8 bytes)			
2	Corrected blocks			
3	Uncorrectable blocks			

**Corrected blocks:** Number of FEC encoding blocks reported as corrected by hardware.

**Uncorrectable blocks:** Number of FEC encoding blocks reported as uncorrectable by hardware.

#### 4.3.49.5.7 Buffer Credit descriptor

The Buffer Credit descriptor contains the buffer-to-buffer credit (see 6.6.2.3). values shared during login between N\_Ports and F\_Ports as shown in table 165.

**Table 165 – Buffer Credit Descriptor**

Bits Word	31 .. 24	23 .. 16	15 .. 08	07 .. 00
0	Buffer Credit Descriptor tag = 0001 0006h			
1	Buffer Credit Descriptor Length (12 bytes)			
2	FC_Port buffer-to-buffer credit			
3	Attached FC_Port buffer-to-buffer credit			
4	Nominal FC_Port RTT			

**FC\_Port buffer-to-buffer credit:** The advertised buffer-to-buffer credit for the Fx\_Port or Nx\_Port for which diagnostic parameters are being provided.

**Attached FC\_Port buffer-to-buffer credit:** The advertised buffer-to-buffer credit received from the directly attached Fx\_Port or Nx\_Port, if any. The Attached FC\_Port buffer-to-buffer credit shall be zero if there is no directly attached Fx\_Port or Nx\_Port.

**Nominal FC\_Port RTT:** The nominal round trip time (i.e., RTT) of the link between the FC\_Port and the attached FC\_Port as determined by the FC\_Port, where a value of zero indicates the RTT is unknown and a non-zero value indicates the RTT of the link expressed in nanoseconds.

### 4.3.49.5.8 Optical Element Data descriptor

The Optical Element Data descriptor contains the optical element data of the SFP or QSFP as shown in table 166.

**Table 166 – Optical Element Data Descriptor**

Bits Word	31 .. 24	23 .. 16	15 .. 08	07 .. 00
0	Optical Element Data Descriptor tag = 0001 0007h			
1	Optical Element Data Descriptor Length (12 bytes)			
2	High Alarm		Low Alarm	
3	High Warning		Low Warning	
4	Optical Element Function Flags			

Optical Element Data descriptor parameters are as provided in “Diagnostic Monitoring Interface for Optical Transceivers” for SFPs (see SFF-8472) and in “Common Management Interface” for QSFPs (see SFF-8636). The parameters provided are:

- a) **High Alarm:** The high alarm value for the operating range of the optical element.
- b) **Low Alarm:** The low alarm value for the operating range of the optical element.
- c) **High Warning:** The high warning value for the operating range of the optical element.
- d) **Low Warning:** The low warning value for the operating range of the optical element.
- e) **Optical Element Function Flags:** The defined Optical Element Function Flags are show in table 167.

**Table 167 – Optical Element Function Flags**

Bits	Description
31 – 28	Optical Element Type: 0 = Reserved 1 = Module Temperature 2 = Module Voltage 3 = Tx Bias 4 = Tx Power 5 = Rx Power 6-15 = reserved
27 – 16	Reserved
15 – 12	Lane 3 Optical Element Type Transgression Flags
11 – 8	Lane 2 Optical Element Type Transgression Flags
7 – 4	Lane 1 Optical Element Type Transgression Flags
3 – 0	Lane 0 Optical Element Type Transgression Flags

If the Optical Element Type field is set to Module Temperature or Module Voltage then the Optical Element Type Transgression flags are in bits 3-0 and bits 15-4 shall be set to 0.

If the Optical Element Function Flags are for an SFP then only Optical Element Type Transgression Flags bits 3-0 are valid and bits 15-4 shall be set to 0.

If the Optical Element Function Flags are for a QSFP then bits 15-0 are valid. All lanes are reported regardless of the operating mode of the QSFP.

The defined Optical Element Type Transgression Flags are shown in table 168.

**Table 168 – Optical Element Type Transgression Flags**

Bits	Description
3	High Alarm - Set to 1 if the operating value has transgressed the high alarm level.
2	Low Alarm - Set to 1 if the operating value has transgressed the low alarm level.
1	High Warning - Set to 1 if the operating value has transgressed the high warning level.
0	Low Warning - Set to 1 if the operating value has transgressed the low warning level.

**4.3.49.5.9 Optical Product Data descriptor**

The Optical Product descriptor contains the product data of the SFP or QSFP as shown in table 169.

**Table 169 – Optical Product Data Descriptor**

Bits Word	31 .. 24	23 .. 16	15 .. 08	07 .. 00
0	Optical Product Data Descriptor tag = 0001 0008h			
1	Optical Product Data Descriptor Length (60 bytes)			
2	MSB			
3	Vendor name			
4				
5				

**Table 169 – Optical Product Data Descriptor**

Bits Word	31 .. 24	23 .. 16	15 .. 08	07 .. 00
6	MSB			
7				
8	Part number			
9	LSB			
10	MSB			
11				
12	Serial number			
13	LSB			
14	Revision			
15				
16	Date			

Optical Product Data descriptor parameters are as provided in “Diagnostic Monitoring Interface for Optical Transceivers” for SFPs (see SFF-8472) and in “Common Management Interface” for QSFPs (see SFF-8636). The parameters provided are:

- a) **Vendor name:** The vendor name is the full name of the corporation, a commonly accepted abbreviation of the name of the corporation, the SCSI company code for the corporation, or the stock exchange code for the corporation (ASCII).
- b) **Part number:** The vendor part number is a field that defines the vendor part number or product name (ASCII).
- c) **Serial number:** The vendor serial number is a field that defines the vendor's serial number (ASCII).
- d) **Revision:** The vendor revision is a field that defines the vendor's revision level for the part number provided (ASCII). SFF vendor revision values consisting of 2-bytes shall be stored in bits 31-16 of the Revision field.
- e) **Date:** The vendor date code is a field that defines the vendor's manufacturing date code (encoded ASCII).

#### 4.3.49 Query Fabric Priority Allocation (QFPA)

##### 4.3.49.1 Overview

The QFPA ELS is used by an N\_Port supporting Priority Tagging (see 9) to query the attached Switch about the Priority field values useable as local VE IDs and the associated QoS priority processing the Fabric provides for those values.

##### 4.3.49.2 Protocol

- a) Query Fabric Priority Allocation Request Sequence; and

b) LS\_ACC or LS\_RJT Reply Sequence.

#### 4.3.49.3 Request Sequence

**Addressing:** The S\_ID field shall be set to the N\_Port\_ID of the N\_Port originating the QFPA Request. The D\_ID shall be set to the F\_Port Controller (FFFFFFEh).

**Payload:** The format of the QFPA Request Payload is shown in table 170.

**Table 170 – QFPA Request Payload**

Bits Word	31 .. 24	23 .. 16	15 .. 8	7 .. 0
0	QFPA (B0h)	00h	00h	00h

#### 4.3.49.4 Reply Sequence

**LS\_RJT:** LS\_RJT signifies the rejection of the QFPA Request.

**LS\_ACC:** LS\_ACC supplies the requested Fabric Priority allocation. The format of the QFPA LS\_ACC Payload is shown in table 171.

**Table 171 – QFPA LS\_ACC Payload**

Bits Word	31 .. 24	23 .. 16	15 .. 8	7 .. 0
0	02h	00h	00h	00h
1	Descriptor list length = Number of Priority Range Descriptors (n) x 12			
2 .. 4	Priority Range Descriptor #1			
5 .. 7	Priority Range Descriptor #2			
..	..			
n x 3 + 1	Priority Range Descriptor #n			

The format of the Priority Range descriptor is shown in table 172.

**Table 172 – Priority Range Descriptor Format**

Bits Word	31 .. 24	23 .. 16	15 .. 8	7 .. 0
0	Descriptor Tag = 0001 0009h			
1	Descriptor Length = 4			
2	Low Range Value	High Range Value	QoS Priority	Local VE ID Use

**Low Range Value:** contains, in the lowest significant seven bits, the lowest value of the described priority range, inclusive. The most significant bit is reserved.

**High Range Value:** contains, in the lowest significant seven bits, the highest value of the described priority range, inclusive. The most significant bit is reserved.



**QoS Priority:** indicates if the described Priority range is part of the subset of Priorities for which the Fabric provides QoS priority processing. The following values are defined for this field:

00h: No QoS priority provided (i.e., best effort).

01h: QoS priority provided.

02h .. FFh: Reserved.

NOTE 5 – As defined in FC-FS-5, an implementation may provide QoS priority processing only for a contiguous subset of priority values. Priority values within this subset are grouped in priority ranges representing increasing QoS priorities.

**Local VE ID Use:** indicates if the values of the Priority field associated with the described Priority range are able to be used as local VE IDs. This field is a 8-bit bitmask defined as follow:

Bit 0: If set to one then Priority field values with the seven most significant bits belonging to the described Priority range and the Tagging Extension bit set to zero may be used as local VE IDs. If set to zero then Priority field values with the seven most significant bits belonging to the described Priority range and the Tagging Extension bit set to zero shall not be used as local VE IDs.

Bit 1: If set to one then Priority field values with the seven most significant bits belonging to the described Priority range and the Tagging Extension bit set to one may be used as local VE IDs. If set to zero then Priority field values with the seven most significant bits belonging to the described Priority range and the Tagging Extension bit set to one shall not be used as local VE IDs.

Bit 8 .. 2: Reserved.

NOTE 6 – As defined in FC-FS-5, the Priority field is an 8-bit field of which the seven most significant bits are the priority and the least significant bit is the Tagging Extension bit.

#### 4.3.50 Update VE Mappings (UVEM)

##### 4.3.50.1 Overview

The UVEM ELS is used by an N\_Port that supports Priority Tagging (see 9) to update the VE Identification Server with changes in the global VE ID to Fabric VE ID mappings when one or more VEs are instantiated or deinstantiated. If the N\_Port is logged in to a device that supports Priority Tagging, the UVEM ELS is used to notify the device about relevant changes in the global VE ID to Fabric VE ID mappings when one or more VEs are instantiated or deinstantiated.

##### 4.3.50.2 Protocol

- a) Update VE Mappings Request Sequence; and
- b) LS\_ACC or LS\_RJT Reply Sequence.

##### 4.3.50.3 Request Sequence

**Addressing:** The S\_ID field shall be set to the N\_Port\_ID of the N\_Port originating the UVEM Request. The D\_ID shall be set to:

- a) the F\_Port Controller (FFFFFFEh) if updating the VE Identification Server;
- b) the N\_Port\_ID of the destination N\_Port if notifying another N\_Port.

**Payload:** The format of the UVEM Request Payload is shown in table 173.

**Table 173 – UVEM Request Payload**

Bits Word	31 .. 24	23 .. 16	15 .. 8	7 .. 0
0	UVEM (B1h)	00h	00h	00h
1	Descriptor list length = $24 + m*28 + q*28$			
2 .. 7	VEM ID Descriptor			
8 .. 14	Instantiated VE Mapping Descriptor #1			
15 .. 21	Instantiated VE Mapping Descriptor #2			
	..			
$7*(m+0)+1 .. 7*(m+1)$	Instantiated VE Mapping Descriptor #m			
$7*(m+1)+1 .. 7*(m+2)$	Deinstantiated VE Mapping Descriptor #1			
$7*(m+2)+1 .. 7*(m+3)$	Deinstantiated VE Mapping Descriptor #2			
	..			
$7*(m+q)+1 .. 7*(m+q+1)$	Deinstantiated VE Mapping Descriptor #q			

The format of the VEM ID descriptor is shown in table 174.

**Table 174 – VEM ID Descriptor**

Bits Word	31 .. 24	23 .. 16	15 .. 8	7 .. 0
0	Descriptor Tag = 0001 000Ah			
1	Descriptor Length = 16			
2	MSB			
3	VEM ID			
4				
5				

**VEM ID:** contains the VEM ID of the originating VEM.

The format of the Instantiated VE Mapping descriptor is shown in table 175.

**Table 175 – Instantiated VE Mapping Descriptor**

Bits Word	31 .. 24	23 .. 16	15 .. 8	7 .. 0
0	Descriptor Tag = 0001 000Bh			
1	Descriptor Length = 20			
2	MSB			
3	Global VE ID			
4				
5				
6	N_Port_ID			Local VE ID

The format of the Deinstantiated VE Mapping descriptor is shown in table 176.

**Table 176 – Deinstantiated VE Mapping Descriptor**

Bits Word	31 .. 24	23 .. 16	15 .. 8	7 .. 0
0	Descriptor Tag = 0001 000Ch			
1	Descriptor Length = 20			
2	MSB			
3	Global VE ID			
4				
5				
6	N_Port_ID			Local VE ID

**Global VE ID:** the identifier used to globally identify a VE.

**N\_Port\_ID:** the N\_Port\_ID of the originating N\_Port.

**Local VE ID:** the value selected to locally identify a VE.

Deinstantiating a VE mapping not registered in the VE Identification Server shall not be treated as an error.

A Deinstantiated VE Mapping descriptor with a NULL Global VE ID and a NULL Local VE ID indicates the deinstantiation of all VE mappings associated with the N\_Port\_ID specified in the descriptor and the VEM ID specified in the VEM ID descriptor. An UVME request payload containing a Deinstantiated VE Mapping descriptor with a NULL Global VE ID and a NULL Local VE ID shall contain only a VEM ID descriptor and the Deinstantiated VE Mapping descriptor with a NULL Global VE ID and a NULL Local VE ID.

#### 4.3.50.4 Reply Sequence

**LS\_RJT:** LS\_RJT signifies the rejection of the UVEM Request.

**LS\_ACC:** LS\_ACC signifies the success of the UVEM processing. The format of the UVEM LS\_ACC Payload is shown in table 177.

**Table 177 – UVEM LS\_ACC Payload**

Bits Word	31 .. 24	23 .. 16	15 .. 8	7 .. 0
0	02h	00h	00h	00h

## 4.4 Extended Link Service Reply Sequences

### 4.4.1 Overview

An ELS Reply Sequence shall signify that the ELS request Sequence is completed. The reply Sequence may contain data in the Payload following the ELS\_Command code word. The format and meaning of the Payload is specified in the request ELS definition.

#### 4.4.2 LS\_ACC

The Link Service Accept (LS\_ACC) ELS reply Sequence shall notify the originator of an ELS request that the ELS request Sequence has been completed. The Responder shall terminate the Exchange by setting the Last Sequence bit (Bit 20) in F\_CTL on the last Data frame of the reply Sequence. The first byte of the Payload shall contain 02h. The remainder of the Payload is unique to the ELS request.

**Protocol:** LS\_ACC is the reply Sequence for several ELSs as indicated in the applicable clause.

**Addressing:** The D\_ID field designates the source of the ELS Sequence being accepted while the S\_ID field designates the destination of the request Sequence being accepted.

**Payload:** The Payload content following the ELS\_Command code (02XXXXXXh) is defined within individual ELS requests.

#### 4.4.3 Reply Sequence

none

#### 4.4.4 Link Service Reject (LS\_RJT)

##### 4.4.4.1 Description

The Link Service Reject (LS\_RJT) shall notify the transmitter of a Link Service request that the Link Service request Sequence has been rejected. A four-byte reason code shall be contained in the Data\_Field. Link Service Reject may be transmitted for a variety of conditions that may be unique to a specific Link Service request (e.g., if the Service Parameters specified in a Login frame were logically inconsistent or in error, a P\_RJT frame would not be transmitted in response, but rather a Link Service Reject).

##### 4.4.4.2 Payload

**Addressing:** The D\_ID field designates the source of the ELS request being rejected while the S\_ID field designates the destination of the request Sequence being rejected.

**Payload:** The first word of the Payload shall contain the ELS\_Command code (01000000h). The next four bytes of this field shall indicate the reason for rejecting the request (see figure 3 and tables 178 and 179). The first error condition encountered shall be the error reported.

NOTE 7 – The applicable ELSs column in table 179 is not necessarily complete (i.e., a given reply may contain a reason code explanation other than what is indicated for it in the table).

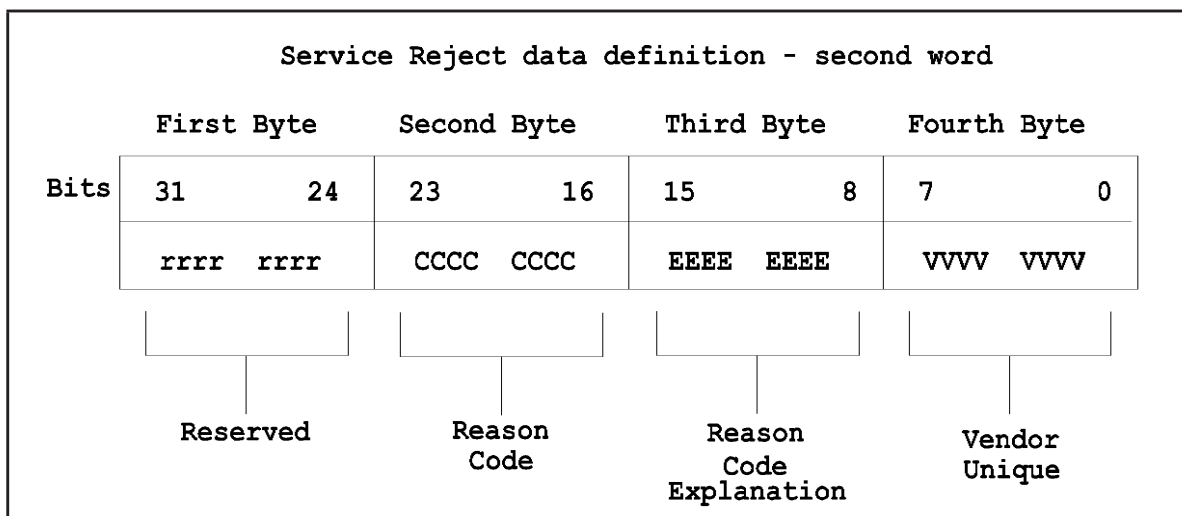

Figure 3 – LS\_RJT format

Table 178 – LS\_RJT Reason Codes

Encoded Value (Bits 23-16)	Description	Explanation
01h	Invalid ELS_Command code	The ELS_Command code in the Sequence being rejected is invalid.
03h	Logical error	The request identified by the ELS_Command code and Payload content is invalid or logically inconsistent for the conditions present.
05h	Logical busy	The Link Service is logically busy and unable to process the request at this time.
07h	Protocol error	This indicates that an error has been detected that violates the rules of the ELS Protocol that are not specified by other error codes.
09h	Unable to perform command request	The Recipient of a Link Service command is unable to perform the request at this time.
0Bh	Command not supported	The Recipient of a Link Service command does not support the command requested.
0Eh	Command already in progress	
20h	FIP Error	See FC-BB-6.
FFh	Vendor specific error (See bits 7-0)	The Vendor specific error bits may be used by Vendors to specify additional reason codes.
Others	Reserved	

**4.4.4.3 Reply Sequence**

none

**Table 179 – LS\_RJT Reason Code Explanations**

<b>Encoded Value (Bits 15-8)</b>	<b>Description</b>	<b>Applicable ELSs</b>
00h	No additional explanation	ADVC, ESTS, FLOGI, PLOGI, LOGO, REC, RLS, RTV, RSI, PRLI, PRLO, TPLS, TPRLO, PDISC, FDISC, ADISC, CSR, RNFT
01h	Service Parm error - Options	FLOGI, PLOGI
03h	Service Parm error - Initiator Ctl	FLOGI, PLOGI
05h	Service Parm error - Recipient Ctl	FLOGI, PLOGI
07h	Service Parm error - Receive Data_Field Size	FLOGI, PLOGI
09h	Service Parm error - Concurrent Seq	FLOGI, PLOGI
0Bh	Service Parm error - Credit	ADVC, FLOGI, PLOGI
0Dh	Invalid N_Port_Name/F_Port_Name	FLOGI, PLOGI
0Eh	Invalid Node_Name/Fabric Name	FLOGI, PLOGI
0Fh	Invalid Common Service Parameters	FLOGI, PLOGI
11h	Invalid Association_Header	RRQ, RSI
13h	Association_Header required	RRQ, RSI
15h	Invalid Originator S_ID	REC, RRQ, RSI
17h	Invalid OX_ID-RX_ID combination	REC, RRQ, RSI
19h	Command (request) already in progress	PLOGI, RSI
1Eh	N_Port Login required	see table 9
1Fh	Invalid N_Port_ID	RDP, RLS
21h	Obsolete	
23h	Obsolete	
25h	Obsolete	

**Table 179 – LS\_RJT Reason Code Explanations(Continued)**

Encoded Value (Bits 15-8)	Description	Applicable ELSs
27h	Obsolete	
29h	Insufficient resources to support Login	FLOGI, PLOGI, FDISC
2Ah	Unable to supply requested data	ADVC, ESTS, RLS, RTV
2Ch	Request not supported	ADVC, ESTS, PRLI, PRLO, TPLS, TPRLO, PDISC, FDISC, ADISC, RNFT
2Dh	Invalid Payload length	FLOGI, PLOGI
30h	Obsolete	
31h	Obsolete	
32h	Obsolete	
33h	Obsolete	
34h	Obsolete	
35h	Obsolete	
36h	Obsolete	
37h	Obsolete	
38h	Obsolete	
40h	Obsolete	
41h	Obsolete	
42h	Obsolete	

**Table 179 – LS\_RJT Reason Code Explanations(Continued)**

<b>Encoded Value (Bits 15-8)</b>	<b>Description</b>	<b>Applicable ELSs</b>
44h	Invalid Port/Node_Name	LCLM
46h	Login Extension not supported	PLOGI, FLOGI
48h	Authentication required (see FC-SP)	PLOGI, FLOGI
50h	Periodic Scan Value not allowed	SRL
51h	Periodic Scanning not supported	SRL
52h	No Resources Assigned	PRLI
60h	MAC addressing mode not supported	FIP specific (see FC-BB-5).
61h	Proposed MAC address incorrectly formed	FIP specific (see FC-BB-5).
62h	VN2VN_Port not in Neighbor Set.	FIP specific (see FC-BB-6).
Others	Reserved	



## 5 FC-4 Link Service

An FC-4 Link Service request solicits a destination Port (i.e., an Fx\_Port or an Nx\_Port) to perform a function or service in order to support an individual FC-4 Device\_Data protocol. The Information Category for a request shall be specified as Unsolicited Control. A FC-4 Link Service reply may be transmitted in answer to a FC-4 Link Service request. The Information Category for a reply shall be specified as Solicited Control. Each request or reply shall be composed of a single Sequence. The format of the request or reply shall be specified by the individual FC-4 being supported and is beyond the scope of this standard. Each Sequence may be composed of one or more frames.

The protocols supported by the FC-4 Link Services shall be performed within a single Exchange, intended exclusively for the purpose. FC-4 Link Service protocols are performed using a two Sequence Exchange. The protocols consist of a request Sequence by the Originator (i.e., an Nx\_Port), transfer of Sequence Initiative (see FC-FS-3), and a reply Sequence from the Responder (i.e., an Nx\_Port or an Fx\_Port). The execution of a FC-4 Link Service may perform sequence abort functions and modify sequence initiative of other exchanges in a protocol specific manner. The Sequence Initiator and Sequence Recipient shall follow the rules for Sequence management and Recovery\_Qualifier reuse as specified in FC-FS-3. The following rules regarding Sequence and Exchange management apply to FC-4 Link Services in addition to the rules specified in FC-FS-3:

- a) FC-4 Link Services shall only be Exchanges originated following N\_Port Login;
- b) the Originator of the Exchange shall use the Discard multiple Sequences Exchange Error Policy (see FC-FS-3) for all FC-4 Link Service Exchanges;
- c) the Originator of an FC-4 Link Service Exchange shall detect an Exchange error following Sequence Initiative transfer if the reply Sequence is not received within a timeout interval equal to twice the value of R\_A\_TOV;
- d) if the Exchange Originator of an FC-4 Link Service Exchange detects an Exchange error, it shall abort the Exchange using ABTS and retry the protocol of the aborted Exchange with a different Exchange; and
- e) if the Sequence Initiator aborts a Sequence using ABTS (Abort Sequence Protocol) due to receiving an ACK with the Abort Sequence bits (5-4) set to 01b, the Sequence Initiator shall re-try the Sequence after the Basic Accept (see FC-FS-3) is received for the aborted Sequence one time only.

R\_CTL bits 31-28 (Word 0) are set = to 0011b to indicate a FC-4 Link\_Data frame. The TYPE field for each FC-4 Link Service frame shall match the FC-4 Device\_Data TYPE field as specified in FC-FS-3.

## 6 Login and Service Parameters

### 6.1 Introduction

The Login procedure is a method by which an Nx\_Port establishes its operating environment with a Fabric, if present, and other destination Nx\_Ports with which it communicates. Fabric Login and N\_Port Login are both accomplished with a similar procedure using different D\_IDs and possibly different S\_IDs.

Login between an Nx\_Port and the Fabric or between two Nx\_Ports is long-lived. The number of concurrent Nx\_Ports with which an Nx\_Port may be logged in with is a function of the Nx\_Port facilities available.

Login between an Nx\_Port and the Fabric or between two Nx\_Ports may use an explicit or implicit method. When Login is referred to throughout other sections of this standard, either the explicit or implicit procedure may be used. Implicit Login is assumed to provide the same functionality as Explicit Login.

Explicit Login is accomplished using a Login (FLOGI or PLOGI) ELS (see 4.3.7) within a new Exchange to transfer the Service Parameters (contained in the Payload) of the Nx\_Port initiating the Login Exchange. The LS\_ACC contains the Service Parameters of the Responder (contained in the Payload).

Implicit Login is a method of defining and specifying the Service Parameters of destination Nx\_Ports by means other than the explicit use of the Login ELS. Specific methods of implicit Login are not defined in this standard.

Implicit Fabric Login, unlike Explicit Fabric Login, does not require the support, within an Nx\_Port, of the FLOGI Link Service request and reply. Implicit Fabric Login may be supported in a variety of ways, requiring varying levels of support within an Nx\_Port.

An Nx\_Port determines its own native N\_Port\_ID through explicit or implicit Login by

- a) the Fabric, if present;
- b) implicit definition; or
- c) assignment in the PLOGI Sequence transmitted to a destination Nx\_Port attached in a point-to-point topology.

Nx\_Ports may collect address identifiers from other potential destination Nx\_Ports from:

- a) a name server function, if present;
- b) implicit definition; or
- c) an alternate initialization procedure.

### 6.2 Fabric Login

#### 6.2.1 Introduction

Login with the Fabric is required for all Nx\_Ports, regardless of the class supported. Communication with other Nx\_Ports shall not be attempted until the Fabric Login procedure is complete.

Fabric Login accomplishes the following functions:

- a) It determines the presence or absence of a Fabric;
- b) If a Fabric is present, it provides the Nx\_Port with the specific set of operating characteristics associated with the entire Fabric, F\_Port\_Name and Fabric\_Name;
- c) If a Fabric is present, it provides the Fabric with the specific set of operating characteristics, N\_Port\_Name and Node\_Name of the Nx\_Port;
- d) If a Fabric is present, the Fabric shall optionally assign or shall confirm the N\_Port\_ID of the Nx\_Port that initiated the Login;
- e) If a Fabric is present, it initializes the buffer-to-buffer Credit;
- f) If the Nx\_Port and the Fabric support Authentication, it enables the subsequent Nx\_Port to Fabric Authentication (see FC-SP); and
- g) If the PN\_Port and the Fabric support Virtual Fabrics, it enables the subsequent negotiation of Virtual Fabrics parameters (see 8.2).
- h) If a Fabric is present, and the Fabric supports FDISC with S\_ID=0, the Fabric and the Nx\_Port may exchange advisory information on the potential use and availability of N\_PORT\_ID resources.

## 6.2.2 Explicit Fabric Login Procedure

### 6.2.2.1 Introduction

The explicit Fabric Login procedure shall require an Nx\_Port to transmit a Fabric Login (FLOGI) Link Service ELS (see 4.3.7).

Explicit Fabric Login replaces previous Service Parameters. The Login procedure shall follow the Exchange and Sequence management rules, the buffer-to-buffer flow control rules, and the end-to-end flow control rules as specified in FC-FS-3.

### 6.2.2.2 Explicit Fabric Login Request

The Nx\_Port shall transmit the FLOGI in a new Exchange. The Payload of FLOGI contains the Service Parameters of the Nx\_Port, a 64-bit N\_Port\_Name of the Nx\_Port, and a 64-bit Node\_Name. The Service Parameters are as specified for F\_Port Login in 6.6. The applicability of the Service Parameters to Fabric Login are given in tables 182 and 187. The Nx\_Port shall assign an OX\_ID and set the D\_ID to the F\_Port Controller Well-known address (i.e., FFFFFFFh).

If the Nx\_Port is unidentified, an Nx\_Port shall set the S\_ID in the FLOGI to 000000h or 0000h || YY. If the Nx\_Port sets the S\_ID to 000000h, the Nx\_Port is requesting the Fabric assign all 24 bits of the N\_Port\_ID. If the Nx\_Port sets the S\_ID to 0000h || YY, the Nx\_Port is requesting the Fabric assign the upper 16 bits, bits 23 to 8, and validate the lower 8 bits, bits 7 to 0, of the N\_Port\_ID. An example of the use of S\_ID of 0000h || YY is FC-AL-2. The lower 8 bits of the N\_Port\_ID are the AL\_PA.

### 6.2.2.3 Responses to Explicit Fabric Login

The following are possible responses the Nx\_Port may receive after transmitting a FLOGI:

- a) LS\_ACC reply Sequence with OX\_ID equal to the OX\_ID of the FLOGI, and the Common Service N\_Port/F\_Port bit set to one (i.e., an Fx\_Port). LS\_ACC is the normal response to a Fabric Login request. The D\_ID of the LS\_ACC shall be the N\_Port\_ID assigned by the Fabric. If the S\_ID in the FLOGI was 000000h, the D\_ID shall be XXXXXX. If the S\_ID in the FLOGI was 0000h || YY, the D\_ID shall be XXXXY. If the S\_ID in the FLOGI was XXXXXX, the D\_ID shall be same value of XXXXXX. The Payload shall include the Service Parameters for the entire Fabric, a 64-bit F\_Port\_Name and 64-bit Fabric\_Name. The Service Parameters are as specified for F\_Port Login in 6.6. The applicability of the Service Parameters to Fabric Login are given in tables 182 and 187. The Nx\_Port may continue operation with other Nx\_Ports if the N\_Port\_ID, F\_Port\_Name, and Fabric\_Name are the same as in a previous Fabric Login or proceed to N\_Port Login;
- b) LS\_ACC reply Sequence with OX\_ID equal to the OX\_ID of the FLOGI, and the Common Service N\_Port/F\_Port bit set to zero (i.e., an Nx\_Port). This indicates a point-to-point connection with another Nx\_Port. The D\_ID of the LS\_ACC shall be the S\_ID of the FLOGI. The Payload shall include the Service Parameters from the FLOGI with all classes marked invalid, a 64-bit N\_Port\_Name and 64-bit Node\_Name of the connected Nx\_Port. If the received N\_Port\_Name is less than its N\_Port\_Name, the Nx\_Port proceeds to N\_Port Login. If the received N\_Port\_Name is greater than its N\_Port\_Name, the Nx\_Port waits for PLOGI from the attached N\_Port.;
- c) F\_BSY with OX\_ID equal to the OX\_ID of the FLOGI. The D\_ID shall be the S\_ID of the FLOGI. The Fabric is busy. The Nx\_Port may retry the FLOGI again later;
- d) P\_BSY Sequence with OX\_ID equal to the OX\_ID of the FLOGI. The D\_ID shall be the S\_ID of the FLOGI. This indicates a point-to-point connection with another Nx\_Port that is currently busy. The Nx\_Port may proceed to N\_Port Login after a delay to allow the destination Nx\_Port to become not busy;
- e) F\_RJT Sequence with OX\_ID equal to the OX\_ID of the FLOGI. The D\_ID shall be the S\_ID of the FLOGI. The Fabric has rejected the FLOGI request. The reason code contained in the Payload determines the Nx\_Port's action. If the reason code is "Class not supported", the Nx\_Port may originate a FLOGI in a different class. If the reason code is "Invalid S\_ID", the Nx\_Port may originate a FLOGI with a different S\_ID:
  - A) If the S\_ID of the rejected FLOGI was 000000h or 0000h || YY, the Nx\_Port may select a 24 bit value, XXXXXX, for its N\_Port\_ID by a method outside this standard and originate a FLOGI with this value in the S\_ID; and
  - B) If the S\_ID of the rejected FLOGI was XXXXXX, the Nx\_Port may select a value of '00 00 00' or '00 00 yy', or a new value 'XX XX XX' for its N\_Port\_ID by a method outside this standard and originate a FLOGI with this value in the S\_ID.
- f) P\_RJT Sequence, with OX\_ID equal to the OX\_ID of the FLOGI. The D\_ID shall be the S\_ID of the FLOGI. This indicates a point-to-point connection with another Nx\_Port. The reason code contained in the Payload determines the Nx\_Port's action. If the reason code is "Class not supported", the Nx\_Port may proceed to N\_Port Login in a different class than used for the FLOGI. For other reason codes, the Nx\_Port should respond accordingly;
- g) LS\_RJT Sequence with OX\_ID equal to the OX\_ID of the FLOGI. The D\_ID of the LS\_RJT shall be the N\_Port\_ID assigned by the Fabric. If the S\_ID in the FLOGI was 000000h, the D\_ID shall be XXXXXX. If the S\_ID in the FLOGI was 0000h || YY, the D\_ID shall be XXXXY. If the S\_ID in the FLOGI was XXXXXX, the D\_ID shall be XXXXXX. The reason code con-

tained in the Payload determines the Nx\_Port's action. The Nx\_Port may alter the Service Parameters based on the reason code and originate a new FLOGI;

- h) No Response may indicate a delivery error, e.g., error on the physical transport. The Nx\_Port shall perform ELS error recovery (see 4.3.2). The Nx\_Port may originate a new FLOGI after recovery; and
- i) If the received N\_Port\_Name is equal to its N\_Port\_Name, then the Nx\_Port is connected to itself and this case is outside the scope of this standard. The FLOGI is discarded.

#### **6.2.2.4 Nx\_Port response to FLOGI**

If an Nx\_Port receives a FLOGI and it is not already logged into a Fabric, then the Nx\_Port shall respond to the received FLOGI with an LS\_ACC reply Sequence with the OX\_ID equal to the OX\_ID of the received FLOGI and the Common Service Parameter N\_Port/F\_Port bit set to zero (i.e., an Nx\_Port). This indicates a point-to-point connection with another Nx\_Port. The D\_ID of the LS\_ACC shall be the S\_ID of the received FLOGI. The Payload shall include the Service Parameters from the received FLOGI with all classes marked invalid, and the 64-bit N\_Port\_Name and 64-bit Node\_Name of the connected Nx\_Port. If the received N\_Port\_Name is less than its N\_Port\_Name, the Nx\_Port proceeds to N\_Port Login. If the received N\_Port\_Name is greater than its N\_Port\_Name, the Nx\_Port waits for PLOGI from the attached N\_Port. If an Nx\_Port receives a FLOGI and it is logged into a Fabric, it shall reject the FLOGI (see 4.3.7.4).

#### **6.2.2.5 Relogin with the Fabric**

During a Login with the Fabric, if the Nx\_Port was previously logged in with the Fabric and the N\_Port\_ID, F\_Port\_Name, and the Fabric\_Name are the same as the previous Login, the Nx\_Port may continue current communications with other Nx\_Ports that it has established Logins with; if the Nx\_Port detects that the N\_Port\_ID, F\_Port\_Name, and/or the Fabric\_Name has changed since the last Fabric Login, the Nx\_Port shall implicitly logout with all Nx\_Ports and wait an R\_A\_TOV timeout period before initiating or accepting communication with other Nx\_Ports. The timeout period shall start when the Nx\_Port detects the change. After waiting the timeout period, new N\_Port Logins are required before the Nx\_Port may communicate with other Nx\_Ports.

#### **6.2.3 SOFs**

Fabric Login shall only be performed in Class 2, or 3. Since the Fabric may not support both classes, the FLOGI Sequence may require retry in a different Class with the appropriate SOF.

Fabric Login is valid for all supported classes as indicated by the validity bits in the FLOGI LS\_ACC Reply Sequence.

Selection of the SOF for the FLOGI Sequence is based on the Classes supported by the originating Nx\_Port. The FLOGI Sequence is transmitted and the appropriate action is specified in 6.2.2.3. If an F\_RJT with reason code "Class of service not supported by entity at FFFFEh" is received, another supported SOF shall be attempted until the Login procedure is complete or until all supported SOF types have been attempted. If all supported SOF types have been attempted and the Fabric has rejected all or timed out, the Fabric and Nx\_Port are incompatible and outside intervention is required.

#### **6.2.4 Frequency**

Login between an Nx\_Port and the Fabric should be long-lived. If Implicit Logout with the Fabric has occurred, it is necessary to perform a new Login with the Fabric (see 6.4.4).

### 6.2.5 Fabric Login completion - Originator

The Originator of the FLOGI request considers Fabric Login to have ended If

- a) in Class 2, the Originator has transmitted the ACK (EOFt) to the LS\_ACC; or
- b) in Class 3, the Originator has received the LS\_ACC.

If Login is ended, the values of buffer-to-buffer Credit are initialized.

### 6.2.6 Fabric Login completion - Responder

The Responder of the FLOGI request considers Fabric Login to have ended if

- a) in Class 2, the Responder has received the ACK (EOFt) to the LS\_ACC; or
- b) in Class 3, the Responder has transmitted the LS\_ACC.

If Fabric Login has ended successfully, the values of buffer-to-buffer Credit are initialized.

## 6.3 N\_Port Login

### 6.3.1 Introduction

N\_Port Login follows the Fabric Login procedure. If a Fabric is present, as determined by performing the Fabric Login procedure, an Nx\_Port proceeds with N\_Port Login according to 6.3.2.2. If a Fabric is not present, as determined by performing the Fabric Login procedure, an Nx\_Port proceeds with N\_Port Login according to 6.3.2.4.

N\_Port Login accomplishes the following functions:

- a) It provides each Nx\_Port with the other Nx\_Port's operating characteristics, N\_Port\_Name and Node\_Name;
- b) If a Fabric is not present, it assigns the native N\_Port\_ID for both Nx\_Ports; and
- c) It initializes the Nx\_Port end-to-end Credit.

In point-to-point topology or between NL\_Ports on the same loop, buffer-to-buffer Credit is initialized N\_Port Login between two Nx\_Ports is complete after each Nx\_Port has received the Service Parameters of the other Nx\_Port. This may be accomplished by either implicit or explicit N\_Port Login.

An Nx\_Port is required to Login with each Nx\_Port with which it intends to communicate. This includes reserved and well-known address identifiers since they are considered to be N\_Ports (see FC-FS-3).

NOTE 8 – It is not required that an Nx\_Port provide the same Login information with each destination Nx\_Port or with the Fabric. However, an Nx\_Port should avoid using contradictory or conflicting parameters with different Login destinations.

The N\_Port Common Service Parameters during N\_Port Login are specified in 6.6.2 (See table 182 for applicability). The N\_Port Class Service Parameters during N\_Port Login are specified in 6.6.5

(See table 187 for applicability). Both the Common Service Parameters and Class Service Parameters apply to each Nx\_Port during N\_Port Login.

NOTE 9 – If an Nx\_Port (A) receives a PLOGI from another Nx\_Port (B), Nx\_Port (A) should verify that it is not already logged in with an Nx\_Port (C) with the same N\_Port\_Name but different Nx\_Port native address identifier and Node\_Name. If so, it should consider the prior Login to be ended and all open Sequences that it originated with or received from the destination Nx\_Port are terminated before accepting the new Login. Such a situation may arise if configuration changes have occurred.

N\_Port Login provides each Nx\_Port with the other Nx\_Port's Service Parameters. Knowledge of a destination Nx\_Port's receive and transmit characteristics is required for data exchanges. Service Parameters of destination Nx\_Ports are saved and used to communicate with those Nx\_Ports. The Service Parameters interchanged between two Nx\_Ports may be asymmetrical. Saving the Service Parameters of destination Nx\_Ports with which an Nx\_Port communicates requires Nx\_Port resources. These resources should be released using the destination N\_Port Logout procedure (see 6.4).

Due to the resetting behavior of a PLOGI (e.g., termination of all open exchanges with the destination port), a port shall only send a PLOGI to a destination port if it is not logged in with the destination port. Examples of why a port is not logged in include:

- a) it has determined that a configuration change has occurred;
- b) it has lost knowledge of the Login parameters with the destination port;
- c) the destination port has responded with a frame that indicates an error condition (e.g., LOGO, P\_RJT);
- d) the local port has logged out the destination port, either implicitly or explicitly, due to resource constraints; and
- e) the destination port failed to respond after 2 times R\_A\_TOV has expired.

A configuration change shall be determined by comparing the Port\_Name, Node\_Name, and Address\_Identifier received in the ACC from an ADISC or PDISC with the values previously established during the previous Login process. A configuration change has occurred if either N\_Port\_Name or N\_Port\_ID do match and any of the three parameters do not match.

## **6.3.2 Explicit N\_Port Login**

### **6.3.2.1 Introduction**

The explicit N\_Port Login procedure shall require an Nx\_Port to transmit a PLOGI Link request Sequence.

Explicit N\_Port Login replaces previous Service Parameters. The Login procedure shall follow the Exchange and Sequence management rules, the buffer-to-buffer flow control rules, and the end-to-end flow control rules as specified in FC-FS-3.

A well-behaved Nx\_Port shall Logout with another Nx\_Port prior to initiating a new N\_Port Login. However, if an Nx\_Port receives or transmits a PLOGI request with another Nx\_Port, it shall abnormally terminate open Sequences and respond to any new Sequences with that Nx\_Port as though a Logout had been previously performed. During the N\_Port Login procedure, other communication with the destination Nx\_Port shall not be initiated or accepted. Once the N\_Port Login procedure has been successfully completed, communication between the Nx\_Ports may be initiated or accepted,

(e.g., if Nx\_Port(A) performs a PLOGI request with Nx\_Port(B) and Nx\_Port(B) transmits the LS\_ACC reply, then either Nx\_Port(A) or Nx\_Port(B) may initiate communication for other protocols. Nx\_Port(B) shall not be required to transmit a PLOGI request Sequence to Nx\_Port(A) unless it wishes to invalidate or alter the existing Login parameters).

### 6.3.2.2 N\_Port Login - Fabric present

The destination Nx\_Port explicit Login procedure requires transmission of a N\_Port Login (PLOGI) Link Service Sequence. The PLOGI is sent within an Exchange with an assigned OX\_ID, the D\_ID of the destination Nx\_Port and a S\_ID of originating Nx\_Port. The Payload of this Sequence contains the Service Parameters, N\_Port\_Name, and Node\_Name of the Nx\_Port originating the PLOGI Sequence. The N\_Port Service Parameters are as specified in 6.6. The applicability of the Service Parameters to N\_Port Login are given in tables 182 and 187.

The normal reply Sequence to a PLOGI Link Service Sequence by an Nx\_Port is a LS\_ACC Link Service Reply Sequence within the Exchange identified by the OX\_ID of the Login Sequence and the RX\_ID assigned by the Responder with a D\_ID of the originating Nx\_Port (PLOGI Sequence) and a S\_ID of the responding Nx\_Port. The Payload of the LS\_ACC contains the Service Parameters of the responding Nx\_Port.

### 6.3.2.3 Responses to N\_Port Login - Fabric present

The following are possible responses the Nx\_Port may receive in response to transmitting a PLOGI with a Fabric present:

- a) LS\_ACC reply Sequence with OX\_ID equal to the OX\_ID of the PLOGI, and the Common Service N\_Port/F\_Port bit = 0 (i.e., Responder is an Nx\_Port) - This is the normal response to a N\_Port Login request. The D\_ID of the LS\_ACC shall be the S\_ID from the PLOGI. The S\_ID of the LS\_ACC shall be D\_ID from the PLOGI. The Payload shall include the Service Parameters for the destination Nx\_Port, a 64-bit N\_Port\_Name and a 64-bit Node\_Name. The N\_Port Service Parameters are as specified for in 6.6. The applicability of the Service Parameters to N\_Port Login are given in tables 182 and 187. The Nx\_Port may begin normal communication with the remote Nx\_Port;
- b) F\_BSY with OX\_ID equal to the OX\_ID of the PLOGI. The D\_ID shall be the S\_ID of the PLOGI. The Fabric is busy. The Nx\_Port may retry the PLOGI again later;
- c) F\_RJT Sequence with OX\_ID equal to the OX\_ID of the PLOGI. The D\_ID shall be the S\_ID of the PLOGI. The Fabric has rejected the PLOGI request. The reason code contained in the Payload determines the Nx\_Port's action. If the reason code is "Invalid D\_ID", N\_Port Login is not possible with the addressed Nx\_Port. The Nx\_Port may attempt Login with other destination Nx\_Ports. For other reason codes, the Nx\_Port should respond according to the code;
- d) P\_BSY Sequence with OX\_ID equal to the OX\_ID of the PLOGI. The D\_ID shall be the S\_ID of the PLOGI. The destination Nx\_Port is busy. The Nx\_Port may retry the PLOGI again later;
- e) P\_RJT Sequence with OX\_ID equal to the OX\_ID of the PLOGI. The D\_ID shall be the S\_ID of the PLOGI. The reason code contained in the Payload determines the Nx\_Port's action. If the reason code is "Class not supported", the Nx\_Port may attempt PLOGI in a different class. For other reason codes, the Nx\_Port should responded according to the code;
- f) PLOGI Sequence. The D\_ID is the N\_Port\_ID of receiving Nx\_Port. The S\_ID is the N\_Port\_ID of the originating Nx\_Port. The OX\_ID is as assigned by the originating Nx\_Port. The Payload shall include a 64-bit N\_Port\_Name and 64-bit Node\_Name of the Nx\_Port originating the



PLOGI. This indicates a collision with N\_Port Login from the destination Nx\_Port. If the received N\_Port\_Name is less than the receiving Nx\_Port's N\_Port\_Name, the Nx\_Port sends LS\_RJT to the originating Nx\_Port with reason code "Command already in progress". If the received N\_Port\_Name is greater than its N\_Port\_Name, the Nx\_Port processes the received PLOGI;

- g) LS\_RJT Sequence with OX\_ID equal to the OX\_ID of the PLOGI. The D\_ID of the LS\_ACC shall be the N\_Port\_ID of the destination Nx\_Port. The reason code contained in the Payload determines the Nx\_Port's action. The Nx\_Port may alter the Service Parameters based on the reason code and originate a new PLOGI;
- h) No Response may indicate a delivery error, e.g., error on the physical transport. The Nx\_Port shall perform ELS error recovery (see 4.3.2). The Nx\_Port may originate a new PLOGI after recovery; and
- i) If the received N\_Port\_Name is equal to its N\_Port\_Name, then the Nx\_Port is connected to itself and this case is outside the scope of this standard.

#### 6.3.2.4 N\_Port Login - No Fabric present

This procedure is based on the Nx\_Port discovering the Fabric is not present during an attempted Fabric Login. (see 6.2.2.3) The destination N\_Port explicit Login procedure requires transmission of a PLOGI Link Service Sequence in a new Exchange.

Only one Nx\_Port in the point-to-point connection is required to transmit a PLOGI. If the N\_Port\_Names are exchanged during Fabric Login, the Nx\_Port with the highest N\_Port\_Name shall transmit the PLOGI.

If either Nx\_Port does not have access to the N\_Port\_Name of the connected Nx\_Port, it may send a PLOGI. The processing requirements for responses received after transmitting a PLOGI resolves the condition of both Nx\_Ports transmitting PLOGI.

An Nx\_Port in a point-to-point configuration transmits PLOGI within a new Exchange. The S\_ID shall be different than the D\_ID. The Payload of this Sequence contains the Service Parameters, N\_Port\_Name, and Node\_Name of the Nx\_Port originating the PLOGI Sequence. The N\_Port Service Parameters are as specified for in 6.6. The applicability of the Service Parameters to N\_Port Login are given in tables 182 and 187.

#### 6.3.2.5 Responses to N\_Port Login - No Fabric present

The following are possible responses the Nx\_Port may receive in response to transmitting a PLOGI in a point-to-point configuration:

- a) LS\_ACC reply Sequence with OX\_ID equal to the OX\_ID of the PLOGI, and the Common Service N\_Port/F\_Port bit = 0 (i.e., the Responder is an Nx\_Port). The D\_ID of the LS\_ACC shall be the S\_ID from the PLOGI. The S\_ID shall be the destination Nx\_Port's N\_Port\_ID assigned by the D\_ID in the PLOGI. The Payload shall include the Service Parameters for the destination Nx\_Port, a 64-bit N\_Port\_Name and a 64-bit Node\_Name. The N\_Port Service Parameters are as specified in 6.6. The applicability of the Service Parameters to N\_Port Login are given in tables 182 and 187. This is the normal response to a N\_Port Login request. The Nx\_Port may begin normal communication with the remote Nx\_Port;
- b) P\_BSY Sequence with OX\_ID equal to the OX\_ID of the PLOGI. The D\_ID shall be the S\_ID of the PLOGI. The destination Nx\_Port is busy. The Nx\_Port may retry the PLOGI again later;

- c) P\_RJT Sequence with OX\_ID equal to the OX\_ID of the PLOGI. The D\_ID shall be the S\_ID of the PLOGI. The reason code contained in the Payload determines the Nx\_Port's action. If the reason code is "Class not supported", the Nx\_Port may attempt N\_Port Login in a different Class. For other reason codes, the Nx\_Port should respond according to the code;
- d) LS\_RJT Sequence with OX\_ID equal to the OX\_ID of the PLOGI. The D\_ID of the LS\_ACC shall be the N\_Port\_ID of the destination Nx\_Port. The reason code contained in the Payload determines the Nx\_Port's action. The Nx\_Port may alter the Service Parameters based on the reason code and originate a new PLOGI;
- e) PLOGI Sequence. The D\_ID is the address identifier of receiving Nx\_Port. The S\_ID is the N\_Port\_ID of the originating Nx\_Port. The OX\_ID is as assigned by the originating Nx\_Port. The Payload shall include a 64-bit N\_Port\_Name and 64-bit Node\_Name of the Nx\_Port originating the PLOGI. This indicates a collision with N\_Port Login from the destination Nx\_Port. If the received N\_Port\_Name is less than the receiving Nx\_Port's N\_Port\_Name, the Nx\_Port sends LS\_RJT to the originating Nx\_Port with reason code "Command already in progress". If the received N\_Port\_Name is greater than its N\_Port\_Name, the Nx\_Port processes the received PLOGI;
- f) No Response may indicate a delivery error, e.g., error on the physical transport. The Nx\_Port shall perform ELS error recovery (see 4.3.2). The Nx\_Port may originate a new PLOGI after recovery; and
- g) If the received N\_Port\_Name is equal to its N\_Port\_Name, then the Nx\_Port is connected to itself and this case is outside the scope of this standard.

### 6.3.3 SOFs

N\_Port Login is only supported in Class 2, and 3. Since the destination Nx\_Port may not support all these classes for Login, the PLOGI Sequence may require retransmission in a different Class with the appropriate SOF in the same manner described for Fabric Login (see 6.2.3). Login is valid for all supported classes as indicated by the validity bits in the PLOGI LS\_ACC Reply Sequence.

### 6.3.4 Frequency

The frequency of N\_Port Login is installation dependent based on the frequency of configuration changes that may alter the N\_Port\_ID within an installation. Service Parameters of other Nx\_Ports are retained until the next N\_Port Login or until N\_Port Logout (implicit or explicit) is performed.

### 6.3.5 N\_Port Login completion - Originator

The Originator of the PLOGI request considers Login to have ended if

- a) in Class 2, the Originator has transmitted the ACK (EOF<sub>t</sub>) to the LS\_ACC; or
- b) in Class 3, the Originator has received the LS\_ACC.

If N\_Port Login is ended with a Fabric present, the value of end-to-end Credit is initialized. If N\_Port Login is ended in a point-to-point topology, the values of buffer-to-buffer and end-to-end Credit are initialized.

### 6.3.6 N\_Port Login completion - Responder

The Responder of the PLOGI request considers Login to have ended if

- a) in Class 2, the Responder has received the ACK (EOFt) to the LS\_ACC; or
- b) in Class 3, the Responder has transmitted the LS\_ACC.

If N\_Port Login is ended with a Fabric present, the value of end-to-end Credit is initialized. If N\_Port Login is ended in a point-to-point topology, the values of buffer-to-buffer and end-to-end Credit are initialized.

## 6.4 Logout

### 6.4.1 Introduction

The destination Logout procedure provides a method for removing service between two N\_Port\_IDs or between an N\_Port\_ID and a Fabric. Logout releases resources, identifiers, and relationships associated with maintaining service between an N\_Port\_ID and a destination N\_Port\_ID or Fabric, including abnormal termination of all open Sequences and Exchanges between the two involved entities. Explicit Nx\_Port Logout may be requested by an Nx\_Port to another Nx\_Port (see 6.4.2). Explicit Fabric Logout may be requested by an Nx\_Port to a Fabric (e.g., to remove a virtual N\_Port\_ID previously assigned by the Fabric) or by a Fabric to an Nx\_Port (see 6.4.3). Implicit Logout may occur between an Nx\_Port and the Fabric (see 6.4.4).

### 6.4.2 Explicit N\_Port Logout Procedure

The explicit N\_Port Logout procedure shall require an Nx\_Port to transmit a Logout (LOGO) Link Service request Sequence (see 4.3.8) to a destination Nx\_Port. The Logout procedure is complete if the responding Nx\_Port transmits a LS\_ACC Link Service reply Sequence.

To explicitly Logout, the initiating Nx\_Port shall terminate other open Sequences that it initiated with the destination Nx\_Port prior to performing Logout, otherwise, the state of other open Sequences is unpredictable. If an Nx\_Port receives a Logout request while another Sequence is open that was initiated from the requesting Nx\_Port, it may reject the Logout request using an LS\_RJT (Link Service Reject).

After an explicit Logout is performed with an Nx\_Port, the default Login Service Parameters specified in table 182 and table 187 shall be functional if Login was explicit. After an explicit Logout is performed with an Nx\_Port, the implicit Login Service Parameters shall be functional if Login was implicit.

### 6.4.3 Explicit Fabric Logout Procedure

The explicit Fabric Logout procedure shall require either:

- a) an Nx\_Port to transmit a Logout (LOGO) Link Service request Sequence (see 4.3.8) to an F\_Port Controller (i.e., Well-known address FFFFFEh); or
- b) an F\_Port Controller to transmit a Logout (LOGO) Link Service request to an Nx\_Port.

The explicit Fabric Logout procedure shall be complete for the responding Nx\_Port, including an F\_Port controller, if it transmits a LS\_ACC Link Service reply Sequence. The explicit Fabric Logout procedure shall be complete for the requesting Nx\_Port, including an F\_Port controller, if it receives a LS\_ACC Link Service reply Sequence.

If an Nx\_Port, including an F\_Port controller, that does not support explicit Fabric Logout receives a LOGO that requests explicit Fabric Logout, it shall reject the explicit Fabric Logout request using an

LS\_RJT with reason code “Command not supported” and reason code explanation “No additional explanation”. If an Nx\_Port, including an F\_Port Controller, that sends a LOGO that requests explicit Fabric Logout receives in reply an LS\_RJT with reason code “Command not supported” and reason code explanation “No additional explanation” the Nx\_Port that sent the LOGO shall implicitly log out the other Nx\_Port.

An F\_Port Controller that supports N\_Port\_ID virtualization shall support explicit Fabric Logout originated by an Nx\_Port.

An Nx\_Port that has requested or accepted explicit Fabric Logout of an N\_Port\_ID shall implicitly log out the N\_Port\_ID with all other N\_Port\_IDs with which the N\_Port\_ID was logged in, and shall not originate frames from the N\_Port\_ID until after it has subsequently been reassigned the N\_Port\_ID by the Fabric. An F\_Port Controller that has explicitly logged out an N\_Port\_ID shall neither originate nor route frames to the N\_Port\_ID until after it has completed a subsequent reassignment of the N\_Port\_ID.

#### **6.4.4 Implicit Logout**

If a PN\_Port receives or transmits an NOS or OLS, all Nx\_Ports at that PN\_Port shall be implicitly logged out from the Fabric, if present, or attached Nx\_Port in a point-to-point topology. Communication with other Nx\_Ports shall not be accepted until the Fabric Login procedure is complete (implicit or explicit).

During Login with the Fabric, if the Nx\_Port detects that the N\_Port\_ID, F\_Port\_Name and/or the Fabric\_Name has changed since the last Fabric Login, and the Clean Address bit is zero, the Nx\_Port shall implicitly logout with all Nx\_Ports and wait an R\_A\_TOV timeout period before initiating or accepting communication with other Nx\_Ports. The timeout period shall start if the Nx\_Port detects the change. After waiting the timeout period, new N\_Port Logins are required before the Nx\_Port may communicate with other Nx\_Ports.

During Login with the Fabric, if the Nx\_Port detects that the N\_Port\_ID, F\_Port\_Name and/or the Fabric\_Name has changed since the last Fabric Login, and the Clean Address bit is set to one, the Nx\_Port shall implicitly logout with all Nx\_Ports before initiating or accepting communication with other Nx\_Ports.

NOTE 10 – If an Nx\_Port receives OLS from the Fabric, the Fabric may be indicating configuration changes internal to the Fabric using the Online to Offline Protocol.

NOTE 11 – If an Nx\_Port is concerned that a partial Fabric Login may be in process using its link immediately preceding its attempted Fabric Login, it may wait an R\_A\_TOV in order to ensure that the response it receives from the Fx\_Port during Fabric Login is associated with its Login request.

**6.4.5 The effects of FLOGI, FDISC, and LOGO**

The effects of FLOGI, FDISC, and LOGO on pre-existing Fabric Logins is summarized in table 180.

**Table 180 – Effects of FLOGI, FDISC, & LOGO on Permanent Port Name (PPN)**

ELS Received (with D_ID FFFFFEh)	Condition of F_Port Controller		
	Condition 1: FLOGI not completed, or all VN_Ports logged out	Condition 2: FLOGI Completed, & at least one VN_Port logged in	Condition 3: FDISC(s) completed, & at least one VN_Port logged in
<b>FLOGI S_ID=0<sup>d</sup></b>	- LS_ACC, assign an N_Port_ID to first VN_Port. - Set PPN of new VN_Port to the F_Port_Name in the FLOGI LS_ACC.	-set BB_Credit to zero -implicit logout of all logged-in VN_Ports - disassociate the logged-out N_Port_IDs with PPN -re-assign one N_Port_ID to new VN_Port - Set PPN of new VN_Port to the F_Port_Name in the FLOGI LS_ACC.	- See Condition 2 (previous column).
<b>FLOGI S_ID not = 0<sup>d</sup></b>	-confirm or reject S_ID (see 6.2.2.3), “Response to Explicit Fabric Login.” - If confirmed, set PPN of FLOGI VN_Port (i.e., new N_Port_ID) to the F_Port_Name in the FLOGI LS_ACC.	-set BB_Credit to zero -Implicit logout of all logged-in VN_Ports - disassociate logged-out VN_Ports from PPN -confirm or reject S_ID (see 6.2.2.3), “Response to Explicit Fabric Login.” - If VN_Port logged-in, set PPN of VN_Port to the F_Port_Name in the FLOGI LS_ACC.	- See Condition 2 (previous column).
<b>FDISC S_ID=0<sup>d</sup></b>	- F_RJT (RC=Login required) for Class 2.  - Discard for Class 3.	- If N_Port ID virtualization supported, LS_ACC (D_ID = assigned N_Port_ID), and set PPN of new VN_Port to the F_Port_Name in the FLOGI LS_ACC. <sup>a, b</sup> - If N_Port_ID virtualization not supported, LS_RJT (RC=command not supported, RCE=Request not supported.)	- LS_ACC (D_ID = assigned N_Port_ID), and set PPN of new VN_Port to the F_Port_Name in the FLOGI LS_ACC. <sup>a, b</sup>
<p><sup>a</sup> If another VN_Port is currently logged into the same F_Port with the same N_Port_Name as contained in the FDISC request payload, the VN_Port associated with the N_Port_Name in the FDISC request shall be implicitly logged out and then the FDISC request processed.</p> <p><sup>b</sup> If an FDISC with S_ID=0 is received and no more N_Port_IDs are available, the F_Port Controller shall respond with an LS_RJT with an LS_RJT Reason Code of Unable to perform command request and an LS_RJT Reason Code Explanation of insufficient resources.</p> <p><sup>c</sup> Any assigned N_Port_ID may be individually logged out and disassociated from the Permanent Port Name, including the FLOGI-assigned N_Port_ID; Name Server attributes for the N_Port_ID are cleared. Other logged-in VN_Ports continue to be associated with their current Permanent Port Names. See FC-GS-6 for a definition of Permanent Port Name.</p> <p><sup>d</sup> Whenever a new N_Port_ID is assigned by either FLOGI or FDISC, or logged out, the Name Server database is updated and the applicable RSCNs are sent.</p>			

**Table 180 – Effects of FLOGI, FDISC, & LOGO on Permanent Port Name (PPN)**

ELS Received (with D_ID FFFFh)	Condition of F_Port Controller		
	Condition 1: FLOGI not completed, or all VN_Ports logged out	Condition 2: FLOGI Completed, & at least one VN_Port logged in	Condition 3: FDISC(s) completed, & at least one VN_Port logged in
<b>FDISC S_ID not = 0</b>	- F_RJT (RC=Login required) for Class 2. - Discard for Class 3.	- If S_ID logged-in, LS_ACC - if S_ID not logged-in: F_RJT (RC=Login required) for Class 2. - Discard for Class 3.	- See Condition 2 (previous column).
<b>OLS/NOS</b>	- Perform Primitive Sequence Protocols (see FC-FS-3).	- implicit logout of all logged-in VN_Ports; Perform Primitive Sequence Protocols (see FC-FS-3). - disassociate the logged-out VN_Ports from PPN.	- See Condition 2 (previous column).
<b>LOGO<sup>d</sup></b>	- LS_ACC, no action	- If S_ID logged-in, log out the individual S_ID only, and disassociate only the logged-out VN_Port from the PPN. <sup>c</sup> - if S_ID not logged-in, LS_ACC no action.	- See Condition 2 (previous column).

<sup>a</sup> If another VN\_Port is currently logged into the same F\_Port with the same N\_Port\_Name as contained in the FDISC request payload, the VN\_Port associated with the N\_Port\_Name in the FDISC request shall be implicitly logged out and then the FDISC request processed.

<sup>b</sup> If an FDISC with S\_ID=0 is received and no more N\_Port\_IDs are available, the F\_Port Controller shall respond with an LS\_RJT with an LS\_RJT Reason Code of Unable to perform command request and an LS\_RJT Reason Code Explanation of insufficient resources.

<sup>c</sup> Any assigned N\_Port\_ID may be individually logged out and disassociated from the Permanent Port Name, including the FLOGI-assigned N\_Port\_ID; Name Server attributes for the N\_Port\_ID are cleared. Other logged-in VN\_Ports continue to be associated with their current Permanent Port Names. See FC-GS-6 for a definition of Permanent Port Name.

<sup>d</sup> Whenever a new N\_Port\_ID is assigned by either FLOGI or FDISC, or logged out, the Name Server database is updated and the applicable RSCNs are sent.

### 6.5 Extended Login Processing

Support for an Extended Login request is specified by the Payload Bit (see 6.6.2.4.21) set to one in a PLOGI or FLOGI request and the associated LS\_ACC. An Extended Login request provides the following information:

- a) Services Availability (see 6.6.8);
- b) Login Extension Data (see 6.6.9); and
- c) Clock Synchronization QoS (see 6.6.10).

If a Login of 256 bytes or more is required and the buffer conditions of the destination port are unknown, a timeout may be avoided with the following procedure:

- 1) issue a Login request with the Payload Bit (see 6.6.2.4.21) set to zero;
- 2) if the Query Buffer Conditions bit (see 6.6.2.4.16) is set to one in the LS\_ACC, issue an RPBC ELS (see 4.3.31).; and
- 3) if both the ELS Receive Data\_Field Size field in the RPBC LS\_ACC Payload and the Buffer-to-Buffer Receive Data\_Field Size field in the Login LS\_ACC Payload are at least 256 bytes, issue a Login request with the Payload Bit set to one.

## **6.6 Service Parameters**

### **6.6.1 ELS and LS\_ACC Payload**

Table 181 defines the Payload format for the FLOGI, PLOGI, and FDISC ELSs and the LS\_ACCs. The definitions of the parameters are applicable to PLOGI, FLOGI, FDISC, PLOGI LS\_ACC, FLOGI LS\_ACC, and FDISC LS\_ACC unless stated otherwise.

NOTE 12 – The Link Service may further limit values supplied during Login as specified by individual Upper Level Protocols.

**Table 181 – FLOGI, PLOGI, FDISC or LS\_ACC Payload**

Bits Word	31 .. 24	23 .. 16	15 .. 08	07 .. 00
0	ELS_Command code			
1	MSB			
..	Common Service Parameters (16 bytes)			
4	LSB			
5	MSB			
6	Port_Name			
6	LSB			
7	MSB			
8	Node_ or Fabric_Name			
8	LSB			
9	MSB			
..	Obsolete (16 bytes)			
12	LSB			
13	MSB			
..	Class 2 Service Parameters (16 bytes)			
16	LSB			
17	MSB			
..	Class 3 Service Parameters (16 bytes)			
20	LSB			
21	MSB			
..	Auxiliary Parameter Data (16 bytes)			
24	LSB			
25	MSB			
..	Vendor Version Level (16 bytes)			
28	LSB			
29	MSB			
..	Services Availability <sup>a</sup> (8 bytes)			
30	LSB			
31	Login Extension Data Length <sup>a</sup>			
32				
..	Reserved			
61				
62	Clock Synchronization QoS <sup>a</sup>			
63	(8 bytes)			
64 to n	Login Extension Data (if any)			

<sup>a</sup> These fields are only present if the Payload Bit (see 6.6.2.4.21) is set to one. If the Payload bit is set to zero, these fields are not present in the Payload (i.e., the Payload is 116 bytes long).



## 6.6.2 Common Service Parameters

### 6.6.2.1 Applicability

Table 182 defines the applicability, by class as well as by PLOGI, FLOGI, PLOGI LS\_ACC and FLOGI LS\_ACC, of the Common Service Parameters to N\_Port Login and Fabric Login. The Default Login Value column (see table 182) refers to the Login values to be used prior to a successful Login. These are words 1-4 in the Payload (see table 182).

**Table 182 – Common Service Parameter applicability**

Service Parameter	Word	Bits	Default Login Value	PLOGI and PLOGI LS_ACC Parameter applicability		FLOGI Parameter applicability		FLOGI LS_ACC Parameter applicability	
				Class		Class		Class	
				2	3	2	3	2	3
FC-PH Version - obsolete	0	31-16	2020h <sup>g</sup>	n	n	n	n	n	n
Buffer-to-buffer Credit	0	15-0	0 or 1 <sup>d</sup>	y	y	y	y	y	y
Common Features	1	31-16							
Continuously increasing relative offset	1	31	0	y	y	n	n	n	n
Clean Address	1	31	0	n	n	n	n	y	y
Multiple N_Port_ID Support	1	31	0	n	n	y	y	n	n
Random relative offset	1	30	0	y	y	n	n	n	n
Virtual Fabrics bit	1	30	0	n	n	y	y	y	y
<p>Legend:</p> <p>“y” indicates yes, applicable (i.e., has meaning);</p> <p>“n” indicates no, not applicable (i.e., has no meaning);</p> <p>“v” indicate the definition is vendor specific.</p>									
<p><sup>a</sup> E_D_TOV resolution and the corresponding value are only meaningful in a point-to-point topology or while doing PLOGI with an NL_Port on the same loop.</p> <p><sup>b</sup> The Common Service Parameter applicability is specified in FC-SP.</p> <p><sup>c</sup> This field shall be set to 00h.</p> <p><sup>d</sup> Default buffer-to-buffer credit = 1 for all ports but an L_Port, and Buffer-to-buffer credit=0 for an L_Port.</p> <p><sup>e</sup> N_Port/F_Port=0 for an N_Port, and N_Port/F_Port=1 for an F_Port.</p> <p><sup>f</sup> BB_Credit Management=0 for an N_Port or F_Port, BB_Credit_Management=1 for an L_Port</p> <p><sup>g</sup> Legacy implementations may check this field. Implementations that are compliant with this standard shall not check this field.</p>									

**Table 182 – Common Service Parameter applicability(Continued)**

Service Parameter	Word	Bits	Default Login Value	PLOGI and PLOGI LS_ACC Parameter applicability		FLOGI Parameter applicability		FLOGI LS_ACC Parameter applicability	
				Class		Class		Class	
				2	3	2	3	2	3
Valid Vendor Version Level	1	29	0	y	y	y	y	n	n
Multiple N_Port_ID Assignment	1	29	0	n	n	n	n	y	y
N_Port/F_Port	1	28	0 or 1 <sup>e</sup>	y	y	y	y	y	y
BB_Credit Management	1	27	0 or 1 <sup>f</sup>	y	y	y	y	n	n
Name Server Session Started	1	27	0	n	n	n	n	y	y
Name Server Session Begin	1	26	0	n	n	y	y	n	n
E_D_TOV Resolution	1	26	0	y <sup>a</sup>	y <sup>a</sup>	n	n	y	y
Energy Efficient LPI Mode Supported	1	25	0	y	y	y	y	y	y
Application_Header Support	1	24	0	y	y	n	n	n	n
Broadcast supported by Fabric	1	24	0	n	n	n	n	y	y
Priority Tagging Supported	1	23	0	y	y	y	y	y	y
Query Data Buffer conditions	1	22	0	y	y	y	y	y	y
<p><b>Legend:</b>                      “y” indicates yes, applicable (i.e., has meaning);                      “n” indicates no, not applicable (i.e., has no meaning);                      “v” indicate the definition is vendor specific.</p>									
<p><sup>a</sup> E_D_TOV resolution and the corresponding value are only meaningful in a point-to-point topology or while doing PLOGI with an NL_Port on the same loop.  <sup>b</sup> The Common Service Parameter applicability is specified in FC-SP.  <sup>c</sup> This field shall be set to 00h.  <sup>d</sup> Default buffer-to-buffer credit = 1 for all ports but an L_Port, and Buffer-to-buffer credit=0 for an L_Port.  <sup>e</sup> N_Port/F_Port=0 for an N_Port, and N_Port/F_Port=1 for an F_Port.  <sup>f</sup> BB_Credit Management=0 for an N_Port or F_Port, BB_Credit_Management=1 for an L_Port  <sup>g</sup> Legacy implementations may check this field. Implementations that are compliant with this standard shall not check this field.</p>									

**Table 182 – Common Service Parameter applicability(Continued)**

Service Parameter	Word	Bits	Default Login Value	PLOGI and PLOGI LS_ACC Parameter applicability		FLOGI Parameter applicability		FLOGI LS_ACC Parameter applicability	
				Class		Class		Class	
				2	3	2	3	2	3
Security bit (see FC-SP)	1	21	0	_b	_b	_b	_b	_b	_b
Clock Synchronization Primitive Capable	1	20	0	y	y	y	y	y	y
R_T_TOV Value	1	19	0	y	y	y	y	y	y
Dynamic Half Duplex Supported	1	18	0	y	y	y	y	y	y
SEQ_CNT/Vendor Specific	1	17	0	y	y	v	v	v	v
Payload Bit	1	16	0	y	y	y	y	y	y
BB_SC_N	1	15-12	0	y	y	y	y	y	y
Buffer-to-Buffer Receive Data_Field Size	1	11-0	128	y	y	y	y	y	y
Set to 00h <sup>c</sup>	2	31-24	0	-	-	-	-	-	-
Nx_Port Total Concurrent Sequences	2	23-16	1	y	y	n	n	n	n
Relative offset by Info Category	2	15-0	0	y	y	n	n	n	n
<p><b>Legend:</b>                      "y" indicates yes, applicable (i.e., has meaning);                      "n" indicates no, not applicable (i.e., has no meaning);                      "v" indicate the definition is vendor specific.</p> <p><sup>a</sup> E_D_TOV resolution and the corresponding value are only meaningful in a point-to-point topology or while doing PLOGI with an NL_Port on the same loop.  <sup>b</sup> The Common Service Parameter applicability is specified in FC-SP.  <sup>c</sup> This field shall be set to 00h.  <sup>d</sup> Default buffer-to-buffer credit = 1 for all ports but an L_Port, and Buffer-to-buffer credit=0 for an L_Port.  <sup>e</sup> N_Port/F_Port=0 for an N_Port, and N_Port/F_Port=1 for an F_Port.  <sup>f</sup> BB_Credit Management=0 for an N_Port or F_Port, BB_Credit_Management=1 for an L_Port  <sup>g</sup> Legacy implementations may check this field. Implementations that are compliant with this standard shall not check this field.</p>									

**Table 182 – Common Service Parameter applicability(Continued)**

Service Parameter	Word	Bits	Default Login Value	PLOGI and PLOGI LS_ACC Parameter applicability		FLOGI Parameter applicability		FLOGI LS_ACC Parameter applicability	
				Class		Class		Class	
				2	3	2	3	2	3
R_A_TOV	2	31-0	10 000	n	n	n	n	y	y
E_D_TOV Value	3	31-0	2 000	y <sup>a</sup>	y <sup>a</sup>	n	n	y	y
<p>Legend:                      “y” indicates yes, applicable (i.e., has meaning);                      “n” indicates no, not applicable (i.e., has no meaning);                      “v” indicate the definition is vendor specific.</p> <p><sup>a</sup> E_D_TOV resolution and the corresponding value are only meaningful in a point-to-point topology or while doing PLOGI with an NL_Port on the same loop.  <sup>b</sup> The Common Service Parameter applicability is specified in FC-SP.  <sup>c</sup> This field shall be set to 00h.  <sup>d</sup> Default buffer-to-buffer credit = 1 for all ports but an L_Port, and Buffer-to-buffer credit=0 for an L_Port.  <sup>e</sup> N_Port/F_Port=0 for an N_Port, and N_Port/F_Port=1 for an F_Port.  <sup>f</sup> BB_Credit Management=0 for an N_Port or F_Port, BB_Credit_Management=1 for an L_Port  <sup>g</sup> Legacy implementations may check this field. Implementations that are compliant with this standard shall not check this field.</p>									

**6.6.2.2 Payload**

The Common Service Parameters Payload for FLOGI is shown in table 183.

**Table 183 – Common Service Parameters - FLOGI**

Bits Word	31 .. 24	23 .. 16	15 .. 12	11 .. 08	07 .. 00
0	FC-PH Version - obsolete		Buffer-to-buffer Credit		
1	Common Features (see table 182)		BB_SC_N	Buffer-to-Buffer Receive Data_Field Size	
2	Reserved		Reserved		
3	Reserved		Reserved		

The Common Service Parameters Payload for PLOGI and PLOGI LS\_ACC is shown in table 184.

**Table 184 – Common Service Parameters - PLOGI and PLOGI LS\_ACC**

Bits Word	31 .. 24	23 .. 16	15 .. 12	11 .. 08	07 .. 00
0	FC-PH Version - obsolete		Buffer-to-buffer Credit		
1	Common Features (see table 182)		BB_SC_N	Buffer-to-Buffer Receive Data_Field size	
2	00h	Total Concurrent Sequences	Relative offset by Information Category		
3	E_D_TOV				

The Common Service Parameters Payload for FLOGI LS\_ACC is shown in table 185.

**Table 185 – Common Service Parameters - FLOGI LS\_ACC**

Bits Word	31 .. 24	23 .. 16	15 .. 12	11 .. 08	07 .. 00
0	FC-PH Version - obsolete		Buffer-to-buffer Credit (Fx_Port)		
1	Common Features (see table 182)		BB_SC_N	Buffer-to-Buffer Receive Data_Field size	
2	R_A_TOV				
3	E_D_TOV				

### 6.6.2.3 Buffer-to-buffer Credit

The buffer-to-buffer Credit field (word 0, bits 15-0) defines the number of buffers available for holding Class 2, or Class 3 frames received. An FC\_Port tracks Buffer-to-buffer Credit as a single entity for all frames subject to buffer-to-buffer flow control (see FC-FS-3). Values in the Buffer-to-buffer Credit field are 1 to 32 767. The value 0 is reserved.

For N\_Port Login, this field shall only be meaningful for an Nx\_Port in a point-to-point topology and between two NL\_Ports on the same loop.

### 6.6.2.4 Common Features

#### 6.6.2.4.1 Continuously increasing relative offset

- 0 = not supported
- 1 = supported

If the continuously increasing relative offset bit (word 1, bit 31) is set to one, the Nx\_Port supplying this parameter shall be capable of supporting continuously increasing relative offset, if present (F\_CTL bit 3), within a Sequence on a frame by frame SEQ\_CNT basis. This bit shall only be applicable to those Information Categories in which an Nx\_Port supports relative offset (i.e., word 2, bits 15-0). See FC-FS-3 for the use of continuously increasing relative offset.

This bit shall be applicable to a Sequence Initiator in addition to a Sequence Recipient for all Classes of Service supported by the Nx\_Port.

**6.6.2.4.2 Clean Address**

0 = No information  
 1 = Clean Address

The Clean Address bit (word 1, bit 31) provides an indication to an Nx\_Port as to whether the address it was assigned by the Fabric had been previously used by another device within R\_A\_TOV. If this bit is set to zero, the assigned address may or may not have been used by a previous device within R\_A\_TOV. If this bit is set to one, the assigned address has not been used by any other device within R\_A\_TOV, or has been assigned to the current device for a previous FLOGI and not been changed within R\_A\_TOV. This bit is only meaningful in the FLOGI LS\_ACC, it is not meaningful in the FLOGI request.

**6.6.2.4.3 Multiple N\_Port\_ID Support**

0 = not supported  
 1 = supported

The Multiple N\_Port\_ID Support bit (word 1, bit 31) shall be set to one to indicate that the PN\_Port supplying this parameter is capable of requesting multiple N\_Port\_IDs using the FDISC ELS. The N\_Port\_ID Support bit shall be set to zero to indicate that the PN\_Port supplying this parameter is not capable of requesting additional N\_Port\_IDs. This bit is only meaningful in the FLOGI request, it is not meaningful in the FLOGI LS\_ACC.

**6.6.2.4.4 Random relative offset**

0 = not supported  
 1 = supported

The random relative offset bit (word 1, bit 30) indicates that the Nx\_Port supplying this parameter shall be capable of supporting random relative offset values, if present (F\_CTL bit 3). Random values may increase, decrease, or otherwise fluctuate within a Sequence. This bit shall only be applicable to those Information Categories in which an Nx\_Port supports relative offset (i.e., word 3, bits 15-0). See FC-FS-3 for the use of random relative offset.

This bit shall be applicable to a Sequence Initiator in addition to a Sequence Recipient for all Classes of Service supported by the Nx\_Port.

**6.6.2.4.5 Virtual Fabrics bit**

0 = not supported  
 1 = supported

The Virtual Fabrics bit (word 1, bit 30) indicates support for Virtual fabrics (see clause 8).

**6.6.2.4.6 Valid Vendor Version Level**

0 = not valid  
 1 = Valid

In PLOGI, PLOGI LS\_ACC, and FLOGI, if the Valid Vendor Version Level bit (word 1, bit 29) is set to one, the Vendor Version Level (words 25 through 28 in table 181) contains valid information. If it is set to zero, the Vendor Version Level field is not meaningful.

**6.6.2.4.7 Multiple N\_Port\_ID Assignment**

0 = not supported

1 = supported

If the Multiple N\_Port\_ID Support bit (word 1, bit 31) in the FLOGI request is one, the Multiple N\_Port\_ID Assignment bit (word 1, bit 29) shall be set to one if the F\_Port supplying this parameter is capable of assigning multiple N\_Port\_IDs to the attached PN\_Port using the FDISC ELS. The Multiple N\_Port\_ID Assignment bit shall be set to zero if the Multiple N\_Port\_ID Support bit in the FLOGI request is zero or to indicate that the F\_Port is not capable of assigning multiple N\_Port\_IDs to the attached PN\_Port if the Multiple N\_Port\_ID Support bit in the FLOGI request is one. This bit is only meaningful in the FLOGI LS\_ACC, it is not meaningful in the FLOGI request.

NOTE 13 – The definition above has been modified from previous revisions of the standard.

**6.6.2.4.8 N\_Port/F\_Port**

0 = Nx\_Port

1 = Fx\_Port

An Nx\_Port shall set the N\_Port/F\_Port bit (word 1, bit 28) to zero for PLOGI, PLOGI LS\_ACC and FLOGI. If an Nx\_Port is connected in a Fabric topology, the Fx\_Port shall set the N\_Port/F\_Port bit to one in the FLOGI LS\_ACC. If an Nx\_Port is connected in a point-to-point topology, the Nx\_Port shall set the N\_Port/F\_Port bit to zero in the FLOGI LS\_ACC.

**6.6.2.4.9 BB\_Credit Management**

0 = BB\_Credit management specified in FC-FS-3 shall be used.

1 = Alternate BB\_Credit management specified in FC-AL-2 shall be used.

The BB\_Credit Management bit (word 1, bit 27) specifies the type of BB\_Credit Management to be used.

**6.6.2.4.10 Name Server Session Begin**

0 = not requested

1 = requested

The Name Server Session Begin bit (i.e., word 1 bit 26) provides an indication whether a Server Session (see FC-GS-6) is requested to be established with the Name Server by emulating the acceptance of a Server Session Begin (i.e., SSB) CT\_IU as part of processing the FLOGI.

The Name Server Session Started bit (see 6.6.2.4.11) provides an indication whether a Server Session has been established with the Name Server.

**6.6.2.4.11 Name Server Session Started**

0 = not established

1 = established

The Name Server Session Started bit (i.e., word 1 bit 27) provides an indication whether a Server Session (see FC-GS-6) has been established with the Name Server as described in 6.6.2.4.10. If the Name Server Session Begin bit (see 6.6.2.4.x) is set to zero in the FLOGI request, then the Name Server Session Started bit shall be set to zero in the corresponding FLOGI LS\_ACC.

**6.6.2.4.12 E\_D\_TOV Resolution**

0 = 1 millisecond  
 1 = 1 nanosecond

The E\_D\_TOV resolution bit (word 1, bit 26) indicates the resolution of the E\_D\_TOV timer. If the bit is set to zero, the timer shall be in increments of 1 millisecond. If the bit is set to one, the timer shall be in increments of 1 nanosecond. See FC-FS-3 for the definition of E\_D\_TOV.

**6.6.2.4.13 Application\_Header Support**

0 = no support  
 1 = supported

The Application Header Support bit (word 1, bit 24) indicates support for receiving an Application\_ - Header (see FC-FS-5). If the Application Header Support bit is set to zero, then the FC\_Port does not support the reception of an Application\_Header. If the Application Header Support

bit is set to one, then the FC\_Port supports the reception of an Application\_Header.

**6.6.2.4.14 Broadcast Supported by Fabric**

0 = Broadcast not supported by the Fabric  
 1 = Broadcast supported by the Fabric

The Broadcast bit (word 1, bit 24) indicates whether broadcast is supported by the Fabric or not. It is only meaningful in the FLOGI LS\_ACC. For broadcast requirements see FC-FS-3.

**6.6.2.4.15 Priority Tagging Supported**

0 = Priority Tagging not supported  
 1 = Priority Tagging supported

The Priority Tagging Supported bit (word 1, bit 23) indicates whether Priority Tagging (see 9) is supported by the Fabric or by a VN\_Port. The Priority Tagging Supported bit may be set to one only if the Priority bit (word 0, bit 23) of the Class Service Parameters is set to one.

N\_Port and Fabric should indicate at FLOGI time support for Priority Tagging via the Priority Tagging Supported bit. N\_Ports should indicate at PLOGI time support for Priority Tagging via the Priority Tagging Supported bit. N\_Ports that support Priority Tagging shall preserve the value of the Priority field across all frames of all Sequences of an Exchange (i.e., the Exchange Originator shall use the same value in the Priority field of the frames of an Exchange it originates and the Exchange Responder shall use the same value as set by the Exchange Originator in the Priority field of the frames that it originates for that Exchange).

**6.6.2.4.16 Query Buffer Conditions**

0 = No buffer conditions to report.  
 1 = Buffer conditions to report.

The Query Buffer Conditions bit (word 1, bit 22) indicates whether or not the FC\_Port has unusual buffer conditions to report. A Report Port Buffer Conditions (RPBC) ELS may be issued to gather the buffer conditions. An FC\_Port shall only set the Query Buffer Conditions to 1 if the FC\_Port supports the RPBC ELS, and any of the following conditions are true:



- a) The ELS Receive Data\_Field Size field is different that the Buffer-to-Buffer Receive Data\_Field Size field in the common service parameters; or
- b) multi-frame ELSs are not supported.

**6.6.2.4.17 Clock Synchronization Primitive Capable**

0 = not Clock Synchronization Primitive Capable  
 1 = Clock Synchronization Primitive Capable

The Clock Synchronization Primitive Capable bit (word 1, bit 20) indicates support for the Primitive method of Clock Synchronization (see FC-FS-3). If the bit is set to zero, the Primitive method of Clock Synchronization is not supported. If the bit is set to one, the meaning is as defined in table 186.

**Table 186 – Clock Synchronization Applicability**

Type	Meaning if bit set to one
Clock Synchronization Server (N_Port Login only)	The Clock Synchronization Server is capable of generating clock synchronization Primitive Signals (see FC-FS-3).
Other FC_Ports (N_Port Login only)	The FC_Port is capable of receiving the clock synchronization Primitive Signals (see FC-FS-3) and acting upon them.
Fabric (FLOGI LS_ACC only)	The Fabric is capable of receiving the clock synchronization Primitive Signals (see FC-FS-3) and acting upon them.

**6.6.2.4.18 R\_T\_TOV value**

0 = Default value of 100 milliseconds.  
 1 = Short value of 100 microseconds.

The R\_T\_TOV value (word 1, bit 19) indicates support for the short value of R\_T\_TOV. If this bit is set to zero, the default value of 100 milliseconds is specified. If it is set to one, the value of 100 microseconds is specified.

**6.6.2.4.19 Dynamic Half Duplex Supported**

0 = DHD not supported  
 1 = DHD supported

The Dynamic Half Duplex Supported bit (word 1, bit 18) indicates support for Dynamic Half Duplex. If it is set to zero, Dynamic Half Duplex is not supported. If it is set to one, the FC\_Port supports the reception of the DHD primitive.

NOTE 14 – DHD is applicable to FC-AL topologies. See FC-AL-2 for a description of DHD behavior.

**6.6.2.4.20 SEQ\_CNT**

Word 1, bit 17 has the following meaning in a PLOGI request and PLOGI response:

0 = Normal rules apply to SEQ\_CNT  
 1 = Continuously Increasing SEQ\_CNT shall be used.

SEQ\_CNT (word 1, bit 17) indicates the requirement on SEQ\_CNT. If the bit is set to zero, normal rules shall apply to SEQ\_CNT usage. If the bit is set to one, the Nx\_Port is guaranteeing that it shall

transmit all frames within an Exchange using a continuously increasing SEQ\_CNT. Each Exchange shall start with SEQ\_CNT set to zero in the first frame, and every frame transmitted after that shall increment the previous SEQ\_CNT by one, even across transfers of Sequence Initiative. Any frames received from the other Nx\_Port in the Exchange shall have no effect on the transmitted SEQ\_CNT (see FC-FS-3).

The definition of word 1, bit 17 is vendor specific in a FLOGI request and FLOGI response.

#### **6.6.2.4.21 Payload Bit**

0 = Payload length is 116 bytes

1 = Payload length in bytes is 256 plus four times the value of the Login Extension Length field

The Payload Bit (word 1 bit 16) indicates the length of the FLOGI or PLOGI Payload. If it is set to zero, the Payload length shall be 116 bytes. If it is set to one, the Payload length in bytes shall be 256 plus four times the value of the Login Extension Length field.

If Payload Bit is 0 in PLOGI or FLOGI, then LS\_ACC sent in response shall have the Payload Bit set to 0.

#### **6.6.2.4.22 BB\_SC\_N**

The Buffer-to-buffer State Change Number (BB\_SC\_N) field (word 1, bits 15-12) specifies the Buffer-to-buffer State Change Number. It indicates that the sender of the PLOGI or FLOGI frame is requesting  $2^{BB\_SC\_N}$  number of frames to be sent between two consecutive BB\_SCs primitives, and  $2^{BB\_SC\_N}$  number of R\_RDY primitives to be sent between two consecutive BB\_SCr primitives. See FC-FS-3 for a description of the BB\_Credit recovery process.

#### **6.6.2.4.23 Buffer-to-Buffer Receive Data\_Field Size**

The Buffer-to-Buffer Receive Data\_Field Size field (word 1, bits 11-0) specifies the largest frame Data\_Field size that may be received by the Nx\_Port supplying the Service Parameters as a Sequence Recipient for:

- a) a Class 2 Data frame; or
- b) a Class 3 Data frame.

The value shall be a multiple of four bytes. Values less than 256 or greater than 2<sup>112</sup> are invalid. An Fx\_Port shall support a Data\_Field size of at least 256 bytes.

#### **6.6.2.4.24 Energy Efficient LPI Mode Supported**

0b = Nx\_Port does not support Energy Efficient LPI Mode Operation (see FC-FS-4)

1b = Nx\_Port supports Energy Efficient LPI Mode Operation (see FC-FS-4)

The Energy Efficient Operation Support bits (Word 1, Bit 25), indicates support for Energy Efficient LPI Mode Operation (see FC-FS-4).

#### **6.6.2.4.25 Total Concurrent Sequences**

Total Concurrent Sequences field (word 2, bits 23 - 16) specifies the total number of Concurrent Sequences for all classes that the Nx\_Port is capable of supporting as a Recipient.

The Total Concurrent Sequences specified by an Nx\_Port shall be less than or equal to the sum of the Concurrent Sequences supported on a Class by Class basis (e.g., an Nx\_Port may specify that it is capable of supporting ten Concurrent Sequences in Class 2 and ten Concurrent Sequences in Class 3. However, the total number of Concurrent Sequences while both Class 2 and 3 are open may be fifteen).

#### **6.6.2.4.26 Relative offset by category**

The relative offset by category field (word 2, bits 15 - 0) shall indicate on a bit-position basis, whether or not relative offset shall be supported for the corresponding Information Category (e.g., if bit 14 = 1 and bit 2 = 1 and the others are set to zero, Information Category 1110b and 0010b frames shall be capable of using relative offset as a Sequence Recipient or a Sequence Initiator). See FC-FS-3 for definition of the Information Category field.

#### **6.6.2.4.27 R\_A\_TOV**

The R\_A\_TOV value shall be specified as a count of 1 ms increments. Therefore, a value of 0000000Ah specifies a time period of 10 milliseconds.

#### **6.6.2.4.28 E\_D\_TOV**

If the E\_D\_TOV Resolution bit (word 1, bit 26) is set to zero, the E\_D\_TOV value shall be specified as a count of 1 millisecond increments. If the E\_D\_TOV Resolution bit is set to one, the E\_D\_TOV value shall be specified as a count of 1 nanosecond increments (e.g., based on the setting of the E\_D\_TOV Resolution bit, a value of 0000000Ah specifies a time period of either 10 milliseconds or 10 nanoseconds).

For PLOGI, the E\_D\_TOV value in the LS\_ACC to the PLOGI shall be greater than or equal to the value in the PLOGI. The E\_D\_TOV value in the LS\_ACC shall be the value used by each Nx\_Port. See FC-FS-3 for definition of E\_D\_TOV.

### **6.6.3 Port\_Name**

The Port\_Name is an eight-byte field (words 5-6) that identifies an Nx\_Port. Each Nx\_Port, including Nx\_Ports that have Well-known addresses, shall provide a Name\_Identifier. Nx\_Ports that are not assigned to Well-known addresses shall provide a Name\_Identifier that is unique within the Fibre Channel interaction space of the Nx\_Port. Bits 63-60 specify the format of the Name\_Identifier. The formats are defined in FC-FS-3.

### **6.6.4 Node\_ or Fabric\_Name**

Node\_Name is applicable to PLOGI, PLOGI LS\_ACC and FLOGI. Fabric\_Name is applicable to FLOGI LS\_ACC.

The Node\_Name or Fabric\_Name is an eight-byte field (words 7-8) that labels a Node or Fabric for identification purposes, such as diagnostics. The Node\_Name and Fabric\_Name are independent of and unrelated to network addressing. Each Node\_Name or Fabric\_Name shall be unique within the Fibre Channel interaction space. Bits 63-60 specify the format of the name. The formats are defined in FC-FS-3.

## 6.6.5 Class Service Parameters

### 6.6.5.1 Applicability

Table 187 defines the applicability, by class as well as by PLOGI, FLOGI, PLOGI LS\_ACC and FLOGI LS\_ACC, of the Class Service Parameters to N\_Port Login and Fabric Login. The Class 2 Service Parameters are given in words 13 - 16. The Class 3 Service Parameters are given in words 17 - 20. The words given in the second column and in the following subclauses are relative to the start of the specific class service parameters field (see table 187). The Default Login Value column (see table 187) refers to the Login values to be used prior to a successful Login.

**Table 187 – Class Service Parameters Applicability**

Service Parameter	Word	Bits	Default Login Value	PLOGI and PLOGI LS_ACC Parameter applicability		FLOGI Parameter applicability		FLOGI LS_ACC Parameter applicability	
				Class		Class		Class	
				2	3	2	3	2	3
Class Validity	0	31	0	y	y	y	y	y	y
Service Options	0	30-16							
Obsolete	0	30							
Obsolete	0	29-28							
Sequential delivery	0	27	0	n	n	y	y	y	y
Simplex dedicated connection - obsolete	0	26	0	n	n	n	n	n	n
Camp-On - obsolete	0	25	0	n	n	n	n	n	n
Buffered Class 1 - obsolete	0	24	0	n	n	n	n	n	n
Priority	0	23	0	y	y	y	y	y	y
Preference	0	22	0	y	y	y	y	y	y
DiffServ QoS	0	21	0	y	y	y	y	y	y
Reserved	0	20-16	0	n	n	n	n	n	n
Initiator Control	0	15-0							
X_ID Reassignment - obsolete	0	15-14	0	n	n	n	n	n	n
Obsolete	0	13-12							
ACK_0 capable	0	11	0	y	n	n	n	n	n
Legend: "y" indicates yes, applicable (i.e., has meaning); "n" indicates no, not applicable (i.e., has no meaning)									

**Table 187 – Class Service Parameters Applicability (Continued)**

Service Parameter	Word	Bits	Default Login Value	PLOGI and PLOGI LS_ACC Parameter applicability		FLOGI Parameter applicability		FLOGI LS_ACC Parameter applicability	
				Class		Class		Class	
				2	3	2	3	2	3
ACK_N Capable - obsolete	0	10	0	n	n	n	n	n	n
ACK generation assistance	0	9	0	y	n	n	n	n	n
Data compression capable - obsolete	0	8	0	n	n	n	n	n	n
Data compression history buffer size - obsolete	0	7-6	0	n	n	n	n	n	n
Data Encryption Capable - obsolete	0	5	0	n	n	n	n	n	n
Clock Synchronization ELS capable	0	4	0	y	y	y	y	y	y
Reserved	0	3-0	0	n	n	n	n	n	n
Recipient Control	1	31-16							
ACK_0 Capable	1	31	0	y	n	n	n	n	n
ACK_N Capable - obsolete	1	30	0	n	n	n	n	n	n
X_ID interlock	1	29	1	y	n	n	n	n	n
Error policy support	1	28-27	0	y	y	n	n	n	n
Reserved	1	26	0	n	n	n	n	n	n
Categories per Sequence	1	25-24	1	y	y	n	n	n	n
Data compression capable - obsolete	1	23	0	n	n	n	n	n	n
Data compression history buffer size - obsolete	1	22-21	0	n	n	n	n	n	n
Data decryption capable – obsolete	1	20	0	n	n	n	n	n	n
Clock Synchronization ELS capable	1	19	0	y	y	y	y	y	y
SEQ_ID unique per Exchange	1	18	0	y	y	n	n	n	n
Reserved	1	17-16	0	n	n	n	n	n	n
Legend: “y” indicates yes, applicable (i.e., has meaning); “n” indicates no, not applicable (i.e., has no meaning)									

**Table 187 – Class Service Parameters Applicability (Continued)**

Service Parameter	Word	Bits	Default Login Value	PLOGI and PLOGI LS_ACC Parameter applicability		FLOGI Parameter applicability		FLOGI LS_ACC Parameter applicability	
				Class		Class		Class	
				2	3	2	3	2	3
Reserved	1	15-12	0	n	n	n	n	n	n
Receive Data_Field Size	1	11-0	128	y	y	n	n	n	n
Reserved	2	31-24	0	n	n	n	n	n	n
Concurrent Sequences	2	23-16	1	y	y	n	n	n	n
Nx_Port end-to-end Credit	2	15-0	1	y	n	n	n	n	n
Reserved	3	31-24	0	n	n	n	n	n	n
Open Sequences per Exchange	3	23-16	1	y	y	n	n	n	n
Reserved	3	15-0	0	n	n	n	n	n	n
Obsolete	3	31-0							
Legend: "y" indicates yes, applicable (i.e., has meaning); "n" indicates no, not applicable (i.e., has no meaning)									

**6.6.5.2 Payload**

The Payload Class Service Parameters using FLOGI is shown in table 188.

**Table 188 – Class Service Parameters - FLOGI**

Bits Word	31 .. 24	23 .. 16	15 .. 12	11 .. 08	07 .. 00
0	Service Options		Initiator Control		
1	Recipient Control		Reserved		
2	Reserved	Concurrent Sequences	Nx_Port End-to-end Credit		
3	Reserved	Open Sequences per Exchange	Reserved		

The Payload Service Parameters using PLOGI and PLOGI LS\_ACC is shown in table 189.

**Table 189 – Class Service Parameters - PLOGI and PLOGI LS\_ACC**

Bits Word	31 .. 24	23 .. 16	15 .. 00
0	Service Options		Initiator Control
1	Recipient Control		Reserved   Receive Data_Field Size
2	Reserved	Concurrent Sequences	Nx_Port End-to-end Credit
3	Reserved	Open Sequences per Exchange	Reserved

The Payload Parameters using FLOGI LS\_ACC is shown in table 190.

**Table 190 – Class Service Parameters - FLOGI LS\_ACC**

Bits Word	31 .. 16	15 .. 00
0	Service Options	Reserved
1	Recipient Control	Reserved
2	Reserved	Reserved
3	Obsolete	

### 6.6.5.3 Class validity

0 = Invalid - Class not supported

1 = Valid - Class supported

The Class validity bit (word 0, bit 31) shall indicate whether this Class is supported or not. If the Class validity bit is set to zero, this set of sixteen bytes shall be ignored. If the Class validity bit is one, this Class shall be supported.

The Class 2 Service Parameters are given in words 13 - 16. The Class 3 Service Parameters are given in words 17 - 20.

### 6.6.5.4 Service options

#### 6.6.5.4.1 Introduction

The service options shall specify optional features of a class of service supported by the port supplying the service parameters.

#### 6.6.5.4.2 Sequential delivery

0 = Out of order delivery allowed

1 = Sequential delivery requested

The Sequential delivery bit (word 0, bit 27) is only meaningful for the class 2 and 3 N\_Port Class Service Parameters in Fabric Login. Out of order frame delivery in class 2 and 3 is the default function by a Fabric. It is not meaningful for N\_Port Login.

If this bit is set to one by an Nx\_Port, it is requesting that all frames delivered to the Nx\_Port requesting this function be delivered in the same order in which the frames were transmitted by the source Nx\_Port. If this bit is set to one by the F\_Port Controller in the LS\_ACC, the Fabric shall deliver Class 2 and 3 frames in the same order as transmitted from any one Nx\_Port in the absence of Fabric events (e.g., Fabric reconfiguration or zoning changes).

A Fabric supporting the sequential delivery feature routes Class 2 and 3 frames via a fixed route through the Fabric to provide in-order frame delivery. This feature does not imply any other alteration to the normal class of service functions (e.g., F\_BSY responses are still possible in Class 2 and Class 3 frames may still be discarded by the Fabric based on normal Class 2 and 3 rules).

If this bit is set to one, the Fabric attempts to maintain the order of delivery of both Data and Link\_Control (Class 2 only) frames to the Nx\_Port requesting this feature in the same order in which the frames were transmitted. Table 191 specifies the meaning of the combination of the Sequential delivery bit for the requesting Nx\_Port and the applicable F\_Port Controller.

**Table 191 – Sequential delivery support**

<b>Nx_Port</b>	<b>F_Port Controller</b>	<b>Meaning</b>
0	0	Neither supports
0	1	Fabric is capable of supporting, Sequential delivery is functional
1	0	Nx_Port support requested, Fabric does not support
1	1	Nx_Port requested, Fabric is capable of supporting, Sequential delivery is functional

### 6.6.5.4.3 Priority

#### 6.6.5.4.3.1 Nx\_Port

0 = non-zero Priority may be tolerated

1 = non-zero Priority shall be tolerated

The Priority bit (word 0, bit 23) has meaning in Class 2, and 3.

If an Nx\_Port performs Login with another Nx\_Port, it sets the Priority bit (word 0, bit 23) to one within the Class of Service to indicate tolerance for non-zero values in the Priority field (see FC-FS-3) in the frame header if CS\_CTL/Priority Enable bit (F\_CTL bit 17) is set to one. The other Nx\_Port indicates tolerance for non-zero values in the Priority field by setting this bit to one in the LS\_ACC. An Nx\_Port that indicates tolerance of non-zero values in the Priority field shall not reject or otherwise deprecate a frame solely because the Priority field is non-zero.

NOTE 15 – Even if an Nx\_Port never intends to set the Priority Field to any value other than zero, the Nx\_Port may still have reason to set the Login Priority bit to one.

An Nx\_Port should not set a non-zero value in the Priority field in a frame sent within a class of service if Login Priority is not indicated by both the destination Nx\_Port and the Fabric. If an Nx\_Port



sets a non-zero value in the Priority field in a frame sent within a class of service and Login Priority is not indicated by both the destination Nx\_Port and the Fabric, then the results are unpredictable.

**6.6.5.4.3.2 Fx\_Port**

0 = Priority is not supported  
 1 = Priority is supported

The Priority bit (word 0, bit 23) has meaning in Class 2, and 3.

If an Nx\_Port performs Login with a Fabric, it requests support for use of the Priority field (See FC-FS-3) by setting the Priority bit (word 0, bit 23) to one. If Priority is set to one in the Login and the LS\_ACC, then both the Nx\_Port and Fabric have agreed that Priority is available for use.

The set of values specified in table 192 give the meaning of the combination of the Priority bit.

**Table 192 – Fabric Login Priority and Preemption Support**

Nx_Port	F_Port Controller	Meaning
0	0	Neither supports Priority
0	1	Fabric is capable of supporting Priority
1	0	Nx_Port support requested, Fabric does not support Priority
1	1	Nx_Port requested, Fabric is capable of supporting Priority, available for use

**6.6.5.4.4 Preference**

**6.6.5.4.4.1 Nx\_Port**

0 = non-zero CS\_CTL may be tolerated  
 1 = non-zero CS\_CTL shall be tolerated

If an Nx\_Port performs Login with another Nx\_Port, it shall indicate tolerance for non-zero CS\_CTL within the Class of Service by setting the Preference bit (word 0, bit 22) to one. The other Nx\_Port indicates tolerance for non-zero CS\_CTL by setting this bit to one in the LS\_ACC. An Nx\_Port that tolerates a non-zero CS\_CTL shall not reject or otherwise deprecate a frame solely because the CS\_CTL field is non-zero.

NOTE 16 – Even if an Nx\_Port never intends to set the PREF bit to any value other than zero, the Nx\_Port may still have reason to set the Login Preference bit to one. Setting the bit to one indicates to the other Nx\_Port that the Nx\_Port shall accept frames with a non-zero CS\_CTL field value.

In Class 2 and 3, if this bit is set to one, the Nx\_Port shall tolerate the PREF field in the CS\_CTL field of the Frame\_Header. Tolerance for CS\_CTL as a Sequence Initiator means that the PREF field may specify Preference to the Fabric. Tolerance for CS\_CTL as a Sequence Recipient means that the Nx\_Port shall ignore the PREF field (see FC-FS-3).

**6.6.5.4.4.2 Fx\_Port**

0 = Normal delivery  
 1 = Preferred delivery functional

If the Preference bit (word 0, bit 22) is set to one by an Nx\_Port, then it is requested that all frames transmitted by the Nx\_Port requesting this function be delivered according to the setting of the PREF field in the CS\_CTL field of the Frame\_Header. If this bit is set to one by the F\_Port Controller, the F\_Port Controller is indicating that it shall deliver Class 2 and 3 frames transmitted by the requesting Nx\_Port according to the setting of the PREF field.

NOTE 17 – An F\_Port Controller that responds with bit 22 set to zero may not itself support Preferred delivery, but other Fabric Elements in the path to the destination may support it. An Nx\_Port may attempt Preferred delivery even if the F\_Port Controller does not indicate support.

If this bit is set to one, the Fabric shall deliver both Data and Link\_Control (class 2 only) frames according to the setting of the PREF field in the CS\_CTL field of the Frame\_Header.

Table 193 summarizes the function of the PREF bit for both Class 2 and Class 3.

**Table 193 – Class 2 and 3 Preference Bit Function**

Nx_Port Word 0, Bit 22	F_Port Controller Word 0, Bit 22	Meaning
0	0	Fabric may be capable of providing Preferred delivery
0	1	Fabric is capable of providing Preferred delivery
1	0	Nx_Port support requested, Fabric may not support Preferred delivery
1	1	Nx_Port requested, Fabric is capable, Preferred delivery is available for use

Table 194 summarizes the relationship between Preferred delivery and sequential delivery for both Class 2 and Class 3.

**Table 194 – Relationship between Preferred delivery and sequential delivery**

Preference Functional	Sequential delivery Functional	Meaning
0	0	Frames may be delivered in any order
0	1	Frames shall be delivered to a destination in the same order received from the source, PREF is ignored
1	0	Frames may be delivered in any order, but frames with PREF set to one may be delivered prior to frames with PREF set to zero
1	1	Frames with PREF set to one shall be delivered to a destination in the same order received from the source relative to each other, and may be delivered prior to frames with PREF set to zero; frames with PREF set to zero shall also be delivered to a destination in the same order received from the source relative to each other

**6.6.5.4.5 DiffServ QoS**

**6.6.5.4.5.1 N\_Port Login**

- 0 = DiffServ QoS not supported
- 1 = DiffServ QoS supported

If an Nx\_Port performs Login with another Nx\_Port, it shall indicate support for Differentiated Services QoS by setting the DiffServ QoS bit (word 0, bit 21) to one. The other Nx\_Port indicates support for Differentiated Services QoS by setting this bit to one in the LS\_ACC. Support of Differentiated Services QoS as an Exchange Originator means that the CS\_CTL/Priority Enable bit (F\_CTL bit 17) is set to zero to indicate that the DSCP field of the CS\_CTL field in the Frame\_Header (word 1, bits 29-24) specifies the Differentiated Services QoS policy. Support of Differentiated Services QoS as an Exchange Responder means that the CS\_CTL/Priority Enable bit (F\_CTL bit 17) is set to zero, indicates that the DSCP field of the CS\_CTL field in the Frame\_Header (word 1, bits 29-24) specifies the Differentiated Services QoS policy (see FC-FS-3).

The DiffServ QoS bit has meaning for both Classes 2 and 3.

**6.6.5.4.5.2 Fabric Login**

- 0 = DiffServ QoS not Supported
- 1 = DiffServ QoS Supported

While doing Fabric Login, an Nx\_Port shall request support for Differentiated Services QoS by setting the DiffServ QoS bit (word 0, bit 21) to one. If the LS\_ACC reply from the F\_Port Controller has this bit set to one, both the Nx\_Port and F\_Port Controller have agreed that Differentiated Services QoS is available for use.

The set of values specified in table 195 give the meaning of the combination of Word 0, bit 21 between the requesting Nx\_Port and the responding F\_Port Controller (see FC-FS-3).

The DiffServ QoS bit has meaning for both Classes 2 and 3.

**Table 195 – DiffServ QoS bit definition**

Nx_Port	F_Port Controller	Description
0	0	Neither supports Differentiated Services QoS
0	1	Fx_Port is capable of supporting Differentiated Services QoS
1	0	Nx_Port support requested, Fx_Port does not support Differentiated Services QoS
1	1	Nx_Port requested, Fx_Port is capable of supporting Differentiated Services QoS, Differentiated Services QoS is available for use

**6.6.5.5 Initiator control**

**6.6.5.5.1 Introduction**

The Initiator Control Flags shall specify which protocols, policies or functions the Sequence Initiator function in the Nx\_Port supplying the Service Parameters requests of the recipient or is capable of as a Sequence initiator.

**6.6.5.5.2 ACK\_0 capability**

- 0 = ACK\_0 incapable
- 1 = ACK\_0 capable

The ACK\_0 capability bit (word 0, bit 11) specifies if the Nx\_Port supplying these Class Service Parameters is capable of support for ACK\_0 as a Sequence Initiator for acknowledgement of an entire Sequence in either Discard or Process Exchange Error Policies. As a Sequence Initiator an Nx\_Port receives and processes ACK frames in response to Data frame transmission. ACK\_0 support is applicable to acknowledged class of service Sequences (see FC-FC-2).

The conditions under which ACK\_0 is supported are defined in table 196 and described in the following text.

**Table 196 – ACK\_0 Support Conditions (Initiator Control)**

Nx_Port A Word 0, Bit 11	Nx_Port B Word 1, Bit 31	Nx_Port A as Sequence Initiator
0	0	ACK_0 not supported
0	1	ACK_0 not supported
1	0	ACK_0 not supported
1	1	ACK_0 supported

If one Nx\_Port (e.g., Nx\_Port A) is capable of receiving ACK\_0 as a Sequence Initiator (word 0, bit 11 set to one) and the other Nx\_Port (e.g., Nx\_Port B) is capable of transmitting ACK\_0 as a Sequence Recipient (word 1, bit 31 set to one), ACK\_0 is supported while Nx\_Port A is the Sequence Initiator and Nx\_Port B is the Sequence Recipient. Otherwise, ACK\_0 shall not be supported while Nx\_Port A is the Sequence Initiator and Nx\_Port B is the Sequence Recipient. ACK\_0 usage shall take precedence over ACK\_1.

ACK\_0 capability may be asymmetrical for a single Nx\_Port (i.e., an Nx\_Port may be capable processing ACK\_0 as a Sequence Initiator, but not be capable of ACK\_0 transmission as a Sequence Recipient). Similarly, an Nx\_Port may be capable of generating ACK\_0 as a Sequence Recipient, but not be capable of ACK\_0 reception as a Sequence Initiator.

**6.6.5.5.3 ACK generation assistance**

- 0 = No ACK generation assistance is provided to Sequence Recipient.
- 1 = ACK generation assistance is provided to Sequence Recipient.

Usage of the ACK generation assistance bit (word 0, bit 9) is specified in FC-FS-3.

**6.6.5.5.4 Clock synchronization ELS capable**

- 0 = Initiator does not have clock synchronization ELS capability
- 1 = Initiator has clock synchronization ELS capability

The Clock synchronization ELS capable bit (word 0, bit 4) is only meaningful from the Clock Synchronization Server well-known address (i.e., FFFFF6h). This bit indicates support for the ELS method of Clock Synchronization. If this bit is set to zero, the Nx\_Port does not support the ELS method of Clock Synchronization. If this bit is set to one, the Nx\_Port is capable of generating the CSU ELS frames. See FC-FS-3.

**6.6.5.6 Recipient control**

**6.6.5.6.1 Introduction**

The Recipient Control Flags shall specify which protocols, policies or functions are supported by the Recipient Initiator function in the Nx\_Port supplying the Service Parameters while acting as a recipient of Data frames.

**6.6.5.6.2 ACK\_0 capability**

- 0 = ACK\_0 incapable
- 1 = ACK\_0 capable

The ACK\_0 capability bit (word 1, bit 31) specifies that the Nx\_Port supplying these Class Service Parameters may or may not be capable of support for ACK\_0 as a Sequence Recipient for acknowledgement of an entire Sequence in either Discard or Process Exchange Error Policies. As a Sequence Recipient an Nx\_Port shall support infinite buffering and be capable of transmitting ACK\_0 frames in response to Data frame transmission. ACK\_0 support is applicable to acknowledged class of service Sequences (see FC-FS-3).

The conditions under which ACK\_0 is supported are defined in table 197 and described in the following text.

**Table 197 – ACK\_0 Support Conditions (Recipient Control)**

Nx_Port A Word 0, Bit 11	Nx_Port B Word 1, Bit 31	Nx_Port A as Sequence Recipient
0	0	ACK_0 not supported
0	1	ACK_0 not supported
1	0	ACK_0 not supported
1	1	ACK_0 supported

If one Nx\_Port (e.g., Nx\_Port A) is capable of receiving ACK\_0 as a Sequence Initiator (Word 0, Bit 11 set to one) and the other Nx\_Port (e.g., Nx\_Port B) is capable of transmitting ACK\_0 as a Sequence Recipient (Word 1, Bit 31 set to one), then ACK\_0 may be used while Nx\_Port A is the Sequence Initiator and Nx\_Port B is the Sequence Recipient. Otherwise, ACK\_0 shall not be supported while Nx\_Port A is the Sequence Initiator and Nx\_Port B is the Sequence Recipient.

ACK\_0 capability may be asymmetrical for a single Nx\_Port (i.e., an Nx\_Port may be capable processing ACK\_0 as a Sequence Initiator, but not be capable of ACK\_0 transmission as a Sequence

Recipient. Similarly, an Nx\_Port may be capable of generating ACK\_0 as a Sequence Recipient, but not be capable of ACK\_0 reception as a Sequence Initiator). If an Nx\_Port sets both Word 0, bit 11 and Word 1, bit 31 to one, then it is capable of ACK\_0 support as either a Sequence Initiator or a Sequence Recipient.

#### 6.6.5.6.3 X\_ID interlock

0 = X\_ID interlock not required

1 = X\_ID interlock required

X\_ID interlock (word 1, bit 29) only applies to Class 2. This bit indicates that the Nx\_Port supplying this parameter requires that an interlock be used during X\_ID assignment in Class 2. In X\_ID assignment, the Sequence Initiator shall set the Recipient X\_ID value to FFFFh in the first Data frame of a Sequence and the Recipient shall supply its X\_ID in the ACK frame corresponding to the first Data frame of a Sequence. The Sequence Initiator shall not transmit additional frames until the corresponding ACK is received. Following reception of the ACK, the Sequence Initiator continues transmission of the Sequence using both assigned X\_ID values (see FC-FS-3).

#### 6.6.5.6.4 Error policy supported

The definition of the Error policy supported bits (word 1, bits 28-27) is shown in table 198.

**Table 198 – Error Policy Bits Definition**

Word 1, bits 28-27	Meaning
00b	Only discard policy supported
01b	Reserved
10b	Both discard and process policies supported
11b	Reserved

These bits are set to specify the types of support possible for missing frame conditions processed by the destination Nx\_Port. The policy used for a given Exchange shall be specified as discard or process by the Exchange Originator (see FC-FS-3).

#### 6.6.5.6.5 Categories per Sequence

The definition of the Categories per Sequence bits (word 1, bits 25-24) is shown in table 199.

**Table 199 – Categories per Sequence Bits Definition**

Word 1, bits 25-24	Meaning
00b	1 Category/Sequence
01b	2 Categories/Sequence
10b	Reserved
11b	More than 2 Categories/Sequence

The setting of these bits shall specify that the Recipient is capable of processing one, two, or more than two Information Categories (R\_CTL bits 27-24 in the Frame\_Header) in a single Sequence. Bits 25-24 are applicable to each Class of Service since support for an individual Class may offer different capabilities in the same Nx\_Port.

While an Nx\_Port is acting as a Sequence Initiator, it shall restrict the number of Information Categories per Sequence based on the Sequence Recipient's capability as specified during N\_Port Login. An Nx\_Port's capability for processing Information Categories in a single Sequence may prohibit that Nx\_Port from communicating in certain FC-4 protocols.

Each FC-4 should allow the ability to communicate using only one Information Category per Sequence but always provide the ability to communicate using multiple Information Categories per Sequence where possible, and when performance may be enhanced.

#### **6.6.5.6.6 Clock synchronization ELS capable**

0 = Recipient does not have clock synchronization ELS capability  
1 = Recipient has clock synchronization ELS capability

The Clock synchronization capable bit (word 1, bit 19) indicates support for the ELS method of Clock Synchronization. If this bit is set to zero, the Nx\_Port or Fabric does not support the ELS method of Clock Synchronization. If this bit is set to one, the Nx\_Port or Fabric is capable of receiving CSU ELS frames and acting upon them (see FC-FS-3).

#### **6.6.5.6.7 SEQ\_ID unique per Exchange**

0 = SEQ\_ID is required to be unique per S\_ID/D\_ID, independent of X\_ID  
1 = SEQ\_ID is only required to be unique per Exchange (see FC-FS-4)

SEQ\_ID unique per Exchange (word 1, bit 18) specifies whether the Sequence Recipient requires SEQ\_ID uniqueness per S\_ID/D\_ID or allows uniqueness per X\_ID. If the SEQ\_ID unique per Exchange bit is set to zero in the PLOGI request or PLOGI LS\_ACC, then the SEQ\_ID shall have a value that is unique among all concurrently open Sequences between the Sequence Initiator and the Sequence Recipient, independent of the X\_ID. If the SEQ\_ID unique per Exchange bit is set to one in the PLOGI request and PLOGI LS\_ACC, then the SEQ\_ID is only required to be unique per Exchange (see FC-FS-4).

#### **6.6.5.7 Receive Data\_Field Size**

The Receive Data\_Field Size is a value (word 1, bits 11-0) that specifies the largest Data\_Field size for a frame (see FC-FS-3) that may be received by the Nx\_Port supplying the Service Parameters as a Sequence Recipient. Values less than 256 or greater than 2<sup>11</sup> are invalid. Values shall be a multiple of four bytes. An Nx\_Port shall support a Data\_Field size of at least 256 bytes.

The Receive Data\_Field Size for Class 2, and Class 3 shall be equal to or less than the Buffer-to-Buffer Receive Data\_Field Size specified in the Common Service Parameters.

#### **6.6.5.8 Concurrent Sequences**

Concurrent Sequences (word 2, bits 23-16) shall specify the number of Sequence Status Blocks available in the Nx\_Port supplying the Service Parameters for tracking the progress of a Sequence as a Sequence Recipient. The maximum number of Concurrent Sequences that may be specified is 255 per Nx\_Port as a Recipient that may be allocated across all classes. The total number of Concurrent Recipient Sequences that may be open across all classes by a single Nx\_Port is specified in the

Common Service Parameter field (see 6.6.2.4.25). Allowable values for this field is 01h - FFh. The value 00 is reserved.

NOTE 18 – The maximum number of open Sequences between two Nx\_Ports is the sum of the Concurrent Sequences fields reported in the PLOGI and LS\_ACC of the PLOGI.

In Class 2 and 3, the SEQ\_ID values shall range from 0 to 255. In Class 2 an Nx\_Port may respond with a P\_BSY to a frame initiating a new Sequence if Nx\_Port resources are not available.

#### **6.6.5.9 end-to-end Credit**

The Nx\_Port End-to-end Credit field (word 2, bits 14-0) is the maximum number of Data frames that may be transmitted by an Nx\_Port without receipt of an accompanying ACK or Link\_Response frames. The minimum value of the Nx\_Port End-to-end Credit field is one. The Nx\_Port End-to-end Credit field specified is associated with the number of buffers available for holding the Data\_Field of a frame and processing the contents of that Data\_Field by the Nx\_Port supplying the Service Parameters. The Nx\_Port End-to-end Credit field is not applicable to Class 3 since ACK frames are not used.

In order to ensure frame identification integrity, the Nx\_Port end-to-end Credit field is defined as a 15-bit field while SEQ\_CNT is a 16-bit field. This ensures that end-to-end Credit never exceeds one-half of the maximum SEQ\_CNT. Bit 15 shall be set to zero.

Valid values for the Nx\_Port End-to-end Credit field are 1 to 32 767. The value 0 is reserved.

#### **6.6.5.10 Open Sequences per Exchange**

The value of open Sequences per Exchange field (word 3, bits 23 - 16) shall specify the maximum number of Sequences that may be open at the Recipient at one time between a pair of Nx\_Ports for one Exchange. The value of X+2 specifies the number of instances of Sequence Status that shall be maintained by the Recipient for a single Exchange in the Exchange Status Block. This value is used for Exchange and Sequence tracking. The value of X limits the link facility resources required for error detection and recovery. The value of X is specified in bits 23-16 (see FC-FS-3).

NOTE 19 – The number of SSBs specified at X+2 to be retained in the ESB ensures that if Sequence streaming rules are followed, the ESB shall contain at least one "good" Sequence that ended normally. Another SSB position was allocated in order to allow for any race or timing conditions that might impact that "good" Sequence.

The open Sequences per Exchange field is valid for PLOGI and PLOGI LS\_ACC only.

#### **6.6.6 Auxiliary Parameter Data**

Auxiliary Parameter Data is valid for all classes.



The format of the Auxiliary Parameter Data is as shown in table 200.

**Table 200 – Auxiliary Parameter Data**

Bits Word	31 .. 24	23 .. 16	15 .. 08	07 .. 00
0	Flags	Reserved		
1	Reserved			
2	Reserved			
3	Reserved		NPIV_CNT	

The Flags field in FLOGI, FDISC, FLOGI LS\_ACC, and FDISC LS\_ACC, is defined as follows:

- a) word 0 bit 31 shall be zero;
- b) word 0 bit 30 shall be one if the Auxiliary Parameter data is valid, and shall be zero if the Auxiliary Parameter Data is not valid; and
- c) word 0 bits 29..24 reserved.

The NPIV\_CNT field in the FDISC is defined as follows:

- a) word 3 bits 0..15 reserved.

The NPIV\_CNT field in the FLOGI is defined as follows:

- b) word 3 bits 0..15 advises the fabric of the number of FDISC with S\_ID=0 operations that the PN\_Port intends to originate. This value shall not limit the use of FDISC with S\_ID=0 operations by either the originator or the responder.

The NPIV\_CNT field in the LS\_ACC response to FLOGI is defined as follows:

- c) word 3 bits 0..15 contain the number of FDISC with S\_ID=0 operations that are likely to be successful, as defined in table 201.

The NPIV\_CNT field in the LS\_ACC response to FDISC is defined as follows:

- d) word 3 bits 0..15 contain the number of additional FDISC with S\_ID=0 operations that are likely to be successful subsequent to this one, as defined in table 201.

**Table 201 – NPIV\_CNT field in LS\_ACC**

Value	Meaning
0 - FFFDh	The number of FDISC with S_ID=0 operations that are likely to be successful.
FFFEh	Greater than FFFDh FDISC with S_ID=0 operations are likely to be successful.
FFFFh	It is not known how many FDISC with S_ID=0 operations are likely to be successful.

### **6.6.7 Vendor Version Level**

Vendor Version Level field (words 25-28) specifies vendor-specific information. If the Valid Version Level bit in the Common Service Parameters field (word 1, bit 29) is set to one, the Vendor Version Level field contains valid information. If the Valid Version Level bit is set to zero, the Vendor Version Level field is not meaningful.

### **6.6.8 Services Availability**

#### **6.6.8.1 Introduction**

This field returns information regarding the Fabric's ability to route to the defined well-known addresses. It is meaningful only for FLOGI LS\_ACC. Only bits 10 - 3 of word 30 are meaningful. Word 29 and bits 31 - 11 and 2 - 0 of word 30 are reserved (see FC-FS-3).

#### **6.6.8.2 Clock Synchronization Server**

If set to one, the Clock Synchronization Server bit (word 30, bit 9) shall indicate that the Fabric supports routing to the well-known Clock Synchronization Server address identifier (FFFFF6h). If set to zero, this bit shall indicate that the Fabric does not support routing to the well-known Clock Synchronization Server address identifier. See FC-FS-3 for the specification of this server.

#### **6.6.8.3 Security Key Distribution Server**

If set to one, the Security Key Distribution Server bit (word 30, bit 8) shall indicate that the Fabric supports routing to the well-known Key Distribution Server address identifier (FFFFF7h). If set to zero, this bit shall indicate that the Fabric does not support routing to the well-known Key Distribution Server address identifier.

#### **6.6.8.4 Management Server**

If set to one, the Management Server bit (word 30, bit 5) shall indicate that the Fabric supports routing to the well-known Management Server address identifier (i.e., FFFFFAh). If set to zero, this bit shall indicate that the Fabric does not support routing to the well-known Management Server address identifier. See FC-GS-6 for the specification of this server.

#### **6.6.8.5 Time Server**

If set to one, the Time Server bit (word 30, bit 4) shall indicate that the Fabric supports routing to the well-known Time Server address identifier (i.e., FFFFFBh). If set to zero, this bit shall indicate that the Fabric does not support routing to the well-known Time Server address identifier.

#### **6.6.8.6 Directory Server**

If set to one, the Directory Server bit (word 30, bit 3) shall indicate that the Fabric supports routing to the well-known Directory Server address identifier (i.e., FFFFFCh). If set to zero, this bit shall indicate that the Fabric does not support routing to the well-known Directory Server address identifier. See FC-GS-6 for the specification of this server.

## 6.6.9 Login Extension

### 6.6.9.1 General

If a port does not support a Login request with the Payload Bit set to one, the port shall reject the Login request with an LS\_RJT. The reason code shall be set to “Logical error” with a reason code explanation of “Invalid Payload length”.

If a port does not support a Login request with a non-zero Login Extension Data Length field, the port shall reject the Login request with an LS\_RJT. The reason code shall be set to “Logical error” with a reason code explanation of “Login Extension not supported”.

If a port receives a Login request containing a page code that it does not support, the port shall reject the Login request with an LS\_RJT. The reason code shall be set to “Logical error” with a reason code explanation of “Login Extension not supported”.

If a port does not support a LS\_ACC reply Sequence with the Payload Bit set to one, the port shall perform an explicit Logout with the port that sent the reply.

### 6.6.9.2 Login Extension Data Length

If the Login Extension Data Length field (word 31) is non-zero, a Login Extension follows the normal payload. The Login Extension Data Length field indicates the length of the Login Extension field in words. The Payload Bit (see 6.6.2.4.21) shall be set to one if this field is non-zero.

### 6.6.9.3 Login Extension format

The Login Extension field is a sequence of zero or more Login Extension Pages. The length in words of the sequence of Login Extension Pages shall be equal to the value of the Login Extension Length field. The format of a Login Extension Page is given in Table 202. Word 0 of the first Login Extension Page, if present, is word 64 of the FLOGI/PLOGI/ACC payload.

**Table 202 – Login Extension Page format**

Bits Word	31 .. 24	23 .. 16	15 .. 08	07 .. 00
0	Page Length (n)		Reserved	Page Code
1	Page Code Specific Data			
...				
n - 1				

**Page Length Field:** The length in words of the following page, including the word containing the page length and page code fields.

**Page Code Field:** The Page Code field specifies the type of page as shown in table 203.

**Table 203 – Page Code Definitions**

Page Code	Meaning
00h - EFh	Reserved
F0h	Vendor Specific
F1h - FFh	Reserved

**Vendor Specific Page:** The format of the Vendor Specific Page is shown in table 204.

**Table 204 – Vendor Specific Page format**

Bits Word	31 .. 24	23 .. 16	15 .. 08	07 .. 00
0	Page Length (n)		Reserved	Page Code (F0h)
1	(MSB) _____ Vendor Identification Data _____ (LSB)			
2	Vendor Specific Data			
3				
...				
n - 1				

**Vendor Identification field:** The value of the Vendor Identification field shall be a T10 Vendor ID. The format and interpretation of the Vendor Specific Data field is vendor specific to the vendor identified by the value of the Vendor Identification field.

**Vendor Specific Data Field:** The Vendor Specific Data field contains vendor specific data and shall be padded to a word boundary.

## 6.6.10 Clock Synchronization Quality of Service

### 6.6.10.1 N\_Port Login

#### 6.6.10.1.1 Applicability

The Clock Synchronization Quality of Service (QoS) field in PLOGI ELS or LS\_ACC (words 62-63) is only meaningful if sent to or received from the Clock Synchronization Server (i.e., FFFFF6h). This field contains meaningful information only if either the Clock Synchronization Primitive Capable bit of the Common features field (word 1, bit 20) is set to one; or if the Clock Synchronization ELS capable bit of one of the N\_Port Class Service Parameter Recipient control fields (word 1, bit 19) is set to one. If this field does not contain meaningful information, it shall be set to zero (see FC-FS-3).

The Clock Synchronization QoS field is defined in table 205.

**Table 205 – N\_Port Clock Synchronization QoS**

Bits Word	31 .. 24	23 .. 16	15 .. 08	07 .. 00
62	CS_QoS_Request	CS_Accuracy	CS_Implemented_MSB	CS_Implemented_LSB
63	CS_Update_Period			

### 6.6.10.1.2 CS\_QoS\_Request

For PLOGI and FLOGI Request, the meaning is defined in table 206. This field is not meaningful for PLOGI LS\_ACC and shall be set to zero.

**Table 206 – FLOGI/PLOGI CS\_QoS\_Request**

Word 62, Bits 31-24	Meaning
00h	The CS_Accuracy, CS_Implemented_MSB, CS_Implemented_LSB, and CS_Update_Period fields are not meaningful in the FLOGI/PLOGI Request.
01h	The CS_Accuracy, CS_Implemented_MSB, CS_Implemented_LSB, and CS_Update_Period fields contain the requested Quality of Service Parameters.
02h – FFh	Reserved

### 6.6.10.1.3 CS\_Accuracy (Mantissa and Exponent)

This field contains the CS\_Accuracy\_Mantissa (word 62, bits 23-21) and CS\_Accuracy\_Exponent (bits word 62, 20-16).

If sent to the Fabric during FLOGI, these bits indicate the accuracy that the Fabric is requested to maintain in passing along to the clients the clock synchronization value it receives from the Clock Synchronization Server (FFFFFF6h).

If sent to the Clock Synchronization Server (FFFFFF6h), these bits indicate the requested accuracy of the clock synchronization value as it leaves the server port.

If received from the Clock Synchronization Server (i.e., FFFFFFF6h), these bits indicate the accuracy of the clock synchronization value as it leaves the server port. Specifically, the server shall supply a CS\_Accuracy value such that the Clock Synchronization value is always within the range of:

$$T_{\text{reference}} \pm (0.5 + \text{CS\_Accuracy\_Mantissa} * 2^{-4}) * 2^{(\text{CS\_Accuracy\_Exponent}-30)},$$

where

- a) T\_reference is the clock reference value internal to the server;
- b) CS\_Accuracy\_Mantissa is a value from 000b to 111b'; and

c) CS\_Accuracy\_Exponent is a value from 00000b to 11111b'.

Example #1, if CS\_Accuracy Mantissa and Exponent are set to 001b and 01011b, respectively, the Clock Synchronization value as it exits the server shall always be within the range of:

$$T_{\text{reference}} \pm 1.073 \mu\text{sec}$$

Example #2, if CS\_Accuracy Mantissa and Exponent are set to 111b and 11000b, respectively, the Clock Synchronization value as it exits the server shall always be within the range of:

$$T_{\text{reference}} \pm 14.65 \text{ msec}$$

#### 6.6.10.1.4 Clock Synchronization Implemented MSB

The Clock Synchronization Implemented MSB field (word 62, bits 13 - 8) is a 6-bit value. Word 62, bits 15-14 are reserved and shall be set to zero.

If sent to the Clock Synchronization Server (i.e., FFFFF6h) during PLOGI, these bits indicate the requested most significant bit position within the 64-bit Clock Count field in the CSU ELS Payload.

If received from the Clock Synchronization Server (i.e., FFFFF6h) this field represents the most significant bit position within the 64-bit Clock Count field that contains meaningful information.

NOTE 20 – The value in the Clock Count field shall wrap around to zero if an overflow occurs from the Clock Synchronization Implemented MSB.

(e.g., a value of 110111b indicates that the MSB of byte 1 of the Clock Count field is the highest bit that contains meaningful information).

#### 6.6.10.1.5 Clock Synchronization Implemented LSB

The Clock Synchronization Implemented LSB field (word 62, bits 13 - 8) field is a 6-bit value. Word 62, bits 7-6 are reserved and shall be set to zero.

If sent to the Clock Synchronization Server (i.e., FFFFF6h) during PLOGI, these bits indicate the requested least significant bit position within the 64-bit Clock Count field in the CSU ELS Payload.

If received from the Clock Synchronization Server (i.e., FFFFF6h), this field represents the least significant bit position within the 64-bit Clock Count field that contains meaningful information.

(e.g., a value of 001000b indicates that the LSB of byte 6 of the Clock Count field is the lowest bit that contains meaningful information).

#### 6.6.10.1.6 Clock Synchronization Update Period

If sent to the Clock Synchronization Server (i.e., FFFFF6h), the Clock Synchronization Update Period field (word 63) indicates the requested time, in microseconds, between consecutive updates from the Clock Synchronization server.

If received from the Clock Synchronization Server (i.e., FFFFF6h), it represents the time, in microseconds, between consecutive updates from the Clock Synchronization server.

This field is not meaningful for FLOGI and shall be set to zero.

**6.6.10.2 Fabric Login**

**6.6.10.2.1 Applicability**

The Clock Synchronization Quality of Service field contains meaningful information only if either Word 1, bit 20 - Clock Synchronization Primitive Capable of the Common features field is set to one, or Word 1, bit 19 - Clock Synchronization ELS capable of the Recipient control field is set to one. If this field does not contain meaningful information, it shall be set to zero (see FC-FS-3).

The Fx\_Port Clock Synchronization Quality of Service field is illustrated in table 207.

**Table 207 – Fx\_Port Clock Synchronization QoS**

Bits Word	31 .. 24	23 .. 16	15 .. 08	07 .. 00
62	Reserved	CS_Transfer_Accuracy	CS_Implemented_MSB	CS_Implemented_LSB
63	Reserved			

**6.6.10.2.2 CS\_Transfer\_Accuracy**

The CS\_Transfer\_Accuracy field contains CS\_Transfer\_Accuracy\_Mantissa (word 62, bits 23-21) and CS\_Transfer\_Accuracy\_Exponent (word 62, bits 20-16).

These bits indicate the accuracy that the Fabric maintains in passing along to the clients the clock synchronization value it receives from the Clock Synchronization Server. Specifically, the Fabric shall supply a CS\_Transfer\_Accuracy value such that the Clock Synchronization value supplied to the clients is always within the range of:

$$(T_{server} + T_{fabric\_delay}) \pm (0.5 + CS\_Accuracy\_Mantissa * 2^{-4}) * 2^{(CS\_Accuracy\_Exponent-30)}$$

where:

- a) T\_server is the value received from the Clock Synchronization Server;
- b) T\_fabric\_delay is the time period between a given value received from the server until the corresponding value is delivered to the client;
- c) CS\_Accuracy\_Mantissa is a value from 000b to 111b'; and
- d) CS\_Accuracy\_Exponent is a value from 00000b to 11111b'.

Example #1, if CS\_Transfer\_Accuracy Mantissa and Exponent are set to 001b and 01011b, respectively, the Clock Synchronization value supplied to the clients shall always be within the range of:

$$(T_{server} + T_{fabric\_delay}) \pm 1.073 \mu\text{sec}$$

Example #2, if CS\_Transfer\_Accuracy Mantissa and Exponent are set to 111b and 11000b, respectively, the Clock Synchronization value supplied to the clients shall always be within the range of:

$$(T_{server} + T_{fabric\_delay}) \pm 14.65 \text{ msec}$$

### **6.6.10.2.3 Clock Synchronization Implemented MSB**

The Clock Synchronization Implemented MSB field (word 62, bits 13 - 8) is a 6-bit value that represents the most significant bit position within the 64-bit Clock Count field that contains meaningful information (e.g., a value of 110111b indicates that the MSB of byte 1 of the Clock Count field is the highest bit that contains meaningful information). Word 62, bits 15-14 are reserved and shall be set to zero.

This field refers to the capabilities of the Fabric in transferring the clock synchronization value that was received from the Clock Synchronization Server (i.e., FFFFF6h) to the clients. It does not refer to the capabilities of the Clock Synchronization Server itself.

### **6.6.10.2.4 Word 0, Bits 7-0 Clock Synchronization Implemented LSB**

This Clock Synchronization Implemented LSB field (word 62, bits 5 - 0) is a 6-bit value that represents the least significant bit position within the 64-bit Clock Count field that contains meaningful information (e.g a value of 001000b indicates that the LSB of byte 6 of the Clock Count field is the lowest bit that contains meaningful information). Word 62, bits 7-6 are reserved and shall be set to zero.

This field refers to the capabilities of the Fabric in transferring the clock synchronization value that was received from the Clock Synchronization Server (i.e., FFFFF6h) to the clients. It does not refer to the capabilities of the Clock Synchronization Server itself.



## 7 Process Login/Logout

### 7.1 Process Login

#### 7.1.1 Introduction

The Process Login (PRLI) ELS request shall be used to establish the operating environment between processes at the originating Nx\_Port and processes at the responding Nx\_Port.

Establishing the operating environment may include the establishment of image pairs and the exchange of Service Parameters. The establishment of image pairs is FC-4 independent and is system structure dependent. The exchange of Service Parameters is FC-4 dependent, and if required by a particular FC-4, shall be specified in the corresponding FC-4 standard.

A Process Login remains in effect until a process logout occurs. The number of concurrent Process Logins in effect at an Nx\_Port is a function of the Nx\_Port facilities available. Process Login is separate from N\_Port Login. Process Login may be either implicit or explicit.

There are 2 types of Process Login:

- a) Implicit Process Login is a method of establishing an operating environment by means other than the explicit use of the PRLI Exchange. Specific methods of Implicit Process Login are not defined in this standard; and
- b) Explicit Process Login is accomplished by using the PRLI ELS Sequence within a separate Exchange to establish an operating environment.

The combination of the D\_ID, S\_ID, and TYPE identify an image pair (see figure 4). Either a single group or multiple groups of related processes may exist behind an Nx\_Port.

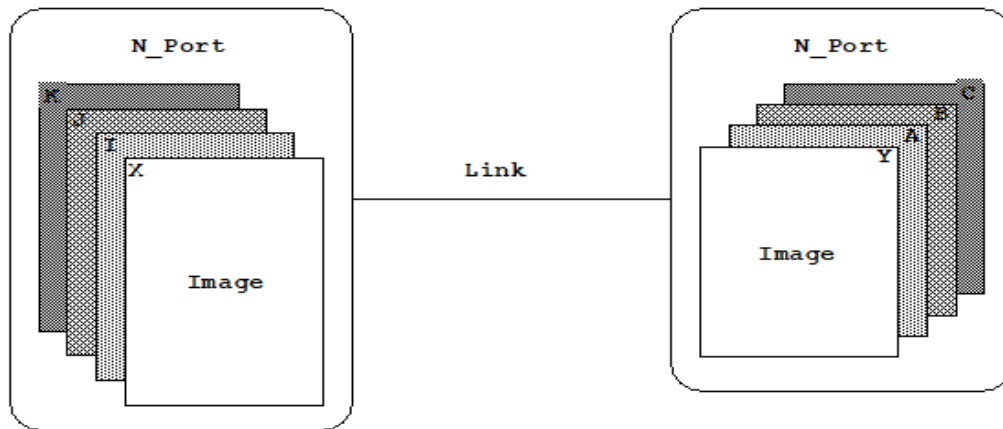

**Figure 4 – Image pairs**

PRLI, if required, is performed after N\_Port Login is successful and prior to other FC-4 transfers. Examples of use of the Process Login function may include image initialization, image re-configuration, or if the Nx\_Port receives an indication that the image pair no longer exists. PRLI allows each image behind an Nx\_Port to separately manage its resources.

PRLI may be used to establish an operating environment between any of the following combinations of Nx\_Port facilities:

- a) two Nx\_Ports;
- b) one Nx\_Port and one Nx\_Port image; and
- c) two Nx\_Port images.

An image pair may be established or modified with a PRLI request and LS\_ACC reply Sequence set. Failure to establish a particular image pair does not affect existing image pairs or the ability to establish other image pair.

PRLI may also be used to exchange Service Parameters without establishing image pairs. However, if an image pair is currently established, a subsequent PRLI request targeted to the same Nx\_Port pair shall identify an image pair in order to modify Service Parameter settings for that image pair.

If a PRLI request is received for an established image pair, the established image pair is unaffected and the PRLI request is processed normally. This allows the exchange of Service Parameters for a FC-4 not specified if the original image pair was established. PRLO shall be used to remove an established image pair.

It shall be the responsibility of the ULPs to ensure that all active operations over an image pair have been properly terminated prior to issuing a PRLI request that replaces Service Parameters. If the replacement of Service Parameters affects any active operations, all open Sequences and Exchanges shall be terminated by invoking Abort Sequence (ABTS). Whether or not the replacement of Service Parameters affects an active operation shall be specified for each Service Parameter by the associated FC-4.

The Nx\_Port originating the PRLI request shall not consider the image pair to be established until it has taken the necessary action to establish the image pair, and has received an LS\_ACC reply Sequence indicating that the image pair has been established. The Nx\_Port responding to the PRLI request does not consider the image pair to be established until the necessary action is taken at the Nx\_Port to establish the image pair, and an LS\_ACC reply Sequence is sent.

If a link error is detected while a PRLI request is received, the appropriate response, if any, is made, and the image pair is not established. If the recipient Nx\_Port is not logged in with the requesting port it shall reply with a LOGO ELS Sequence, or with an LS\_RJT ELS Sequence with a reason code of "Unable to perform command request" and a reason code explanation of "N\_Port Login required". If an LS\_RJT is sent in response to a PRLI request for an image pair that is already established, the existing image pair is unaffected. If an LS\_RJT, P\_BSY, F\_BSY, P\_RJT, or F\_RJT response is received to a PRLI request, the PRLI request may be retried until the image pair is established. The number of retries is system dependent. In the case of LS\_RJT, whether or not the PRLI is retried depends on the LS\_RJT reason code.

In the event that there is an error in the response to establish an image pair, the originating Nx\_Port shall not assume that the requested action has or has not taken place. If the Nx\_Port that originates a PRLI request receives no valid response, the Nx\_Port should retry the request. The number of retries is system dependent.

## **7.1.2 Mode of operation**

### **7.1.2.1 Informative mode**

Service Parameter information is exchanged enabling subsequent negotiation for image pair establishment.

### 7.1.2.2 Binding mode

Information is exchanged that explicitly establishes a relationship between processes in the communicating Nx\_Ports. The relationship does not allow any communication types or paths other than those established by the PRLI.

The use of a Binding PRLI page requires that the Originator have precise and detailed knowledge of the PAs and capabilities available in the Responder. That information may be obtained from Directory Services, implicitly from configuration information obtained outside the scope of FC, or by performing an Informative PRLI.

Binding or Informative mode is determined by the setting of the Establish Image Pair bit in the PRLI request page.

The Service Parameters included in a page may be either requirements or capabilities. Capabilities indicate those FC-4 properties that describe the role and state of the node in the FC-4 (e.g., channel or device for FC-SB-4, initiator or target for FCP-2, and similar values). Requirements indicate those FC-4 properties that shall be agreed upon by both nodes for operation with a FC-4.

## 7.2 Process Logout

The Process Logout (PRLO) ELS request shall be used to request invalidation of the operating environment between an image at the initiating Nx\_Port and an image at the recipient Nx\_Port. PRLO frees resources committed by a previous PRLI function. ULP behavior following successful execution of the PRLO function is specified in the corresponding FC-4 standard.

Examples of PRLO usage include image re-configuration and TYPE-specific reset of Process Login Service Parameters.

TYPE-specific Service Parameter settings may be reset or image pairs removed with a PRLO request and LS\_ACC reply Sequence set. Other TYPE-specific Service Parameter settings or image pairs associated with the same or different image pairs or Nx\_Ports shall be unaffected. After TYPE-specific Service Parameter settings are reset or image pair is removed, Information Units may not be sent or received for the specified FC-4 TYPE using that image pair and Nx\_Port combination specified in the PRLO request.

If a PRLO request is received for an image pair or FC-4 TYPE that does not exist, the request is accepted, provided that no link errors are detected, and the LS\_ACC response is sent.

The Nx\_Port originating the PRLO request shall not consider an image pair to be removed until it receives an LS\_ACC reply Sequence. The Nx\_Port responding to the PRLO request shall not consider an image pair to be removed or TYPE-specific Service Parameter settings to be reset, as appropriate, until the LS\_ACC reply Sequence is sent. An Nx\_Port that receives a P\_BSY, F\_BSY, P\_RJT, or F\_RJT reply in response to a PRLO request may retry the PRLO request. The number of retries is system dependent.

Unless the requesting Nx\_Port receives a valid response to a PRLO request, that Nx\_Port shall not assume that the requested action has or has not taken place. If the Nx\_Port that originates a PRLO request receives no valid response, the Nx\_Port should retry the request. The number of retries is vendor unique.

A PRLO page identifies a particular image pair to logout. Only that image pair is logged out. No further communication for the affected FC-4(s) is possible between these two images. It is the responsibility of the ULPs to ensure that all active operations over an image pair have been orderly and

properly terminated prior to issuing a PRLO request. Following PRLO execution, all active Sequences and Exchanges shall be terminated by invoking Abort Sequence (ABTS). On-going operations and states for other image pairs are not affected.

If a ULP attempts to communicate over an image pair that has not been established or has been abnormally terminated, the communication shall be acknowledged in the normal manner. The Originator may then perform a PRLO operation for the affected image pair in order to properly terminate the operating environment at both the Originator and Responder.

## 8 Virtual Fabrics PN\_Port Support

### 8.1 Overview

The Virtual Fabric Tagging Header (VFT\_Header, see FC-FS-3) allows Fibre Channel frames to be tagged with the Virtual Fabric Identifier (VF\_ID) of the Virtual Fabric (VF) to which they belong. Tagged frames (i.e., frames with a VFT\_Header) belonging to different Virtual Fabrics may be transmitted over the same physical link. The VFT\_Header may be supported by Multiplexers for PN\_Ports, PF\_Ports, and PE\_Ports (see FC-FS-3).

### 8.2 Enabling VFT Tagging on PN\_Ports

The use of Virtual Fabrics is negotiated if FLOGI is performed via the Virtual Fabrics bit of the FLOGI Common Service Parameters (see table 182).

If set to one in the FLOGI request, the Virtual Fabrics bit indicates that the sending PN\_Port may negotiate Virtual Fabrics parameters. If set to one in the FLOGI LS\_ACC reply, the Virtual Fabrics bit indicates that the Fabric requires the PN\_Port to initiate an EVFP transaction (see 4.3.38). Table 208 shows the usage of the Virtual Fabrics bit.

**Table 208 – Virtual Fabrics Bit Usage**

Requesting PN_Port	PF_Port Configuration	Behavior
Virtual Fabrics Bit = 0b	Virtual Fabrics Not Allowed	LS_ACC with Virtual Fabrics Bit = 0b
Virtual Fabrics Bit = 1b	Virtual Fabrics Not Allowed	LS_ACC with Virtual Fabrics Bit = 0b
Virtual Fabrics Bit = 0b	Virtual Fabrics Allowed	LS_ACC with Virtual Fabrics Bit = 0b
Virtual Fabrics Bit = 1b	Virtual Fabrics Allowed	LS_ACC with Virtual Fabrics Bit = 1b

If the PF\_Port requests the PN\_Port to initiate an EVFP transaction, the D\_ID of the FLOGI LS\_ACC shall be set to 000000h. In this manner the link flow control parameters (e.g., Buffer-to-buffer Credit and Buffer-to-Buffer Receive Data\_Field Size) are negotiated, but no N\_Port\_ID is assigned to the PN\_Port. The PN\_Port may continue the initialization process by using the N\_Port Controller Well Known Address (i.e., FFFF0h, see FC-FS-3) as S\_ID to perform an Authentication transaction or an EVFP transaction. Figure 5 shows the initialization process to enable Virtual Fabrics at a PN\_Port.

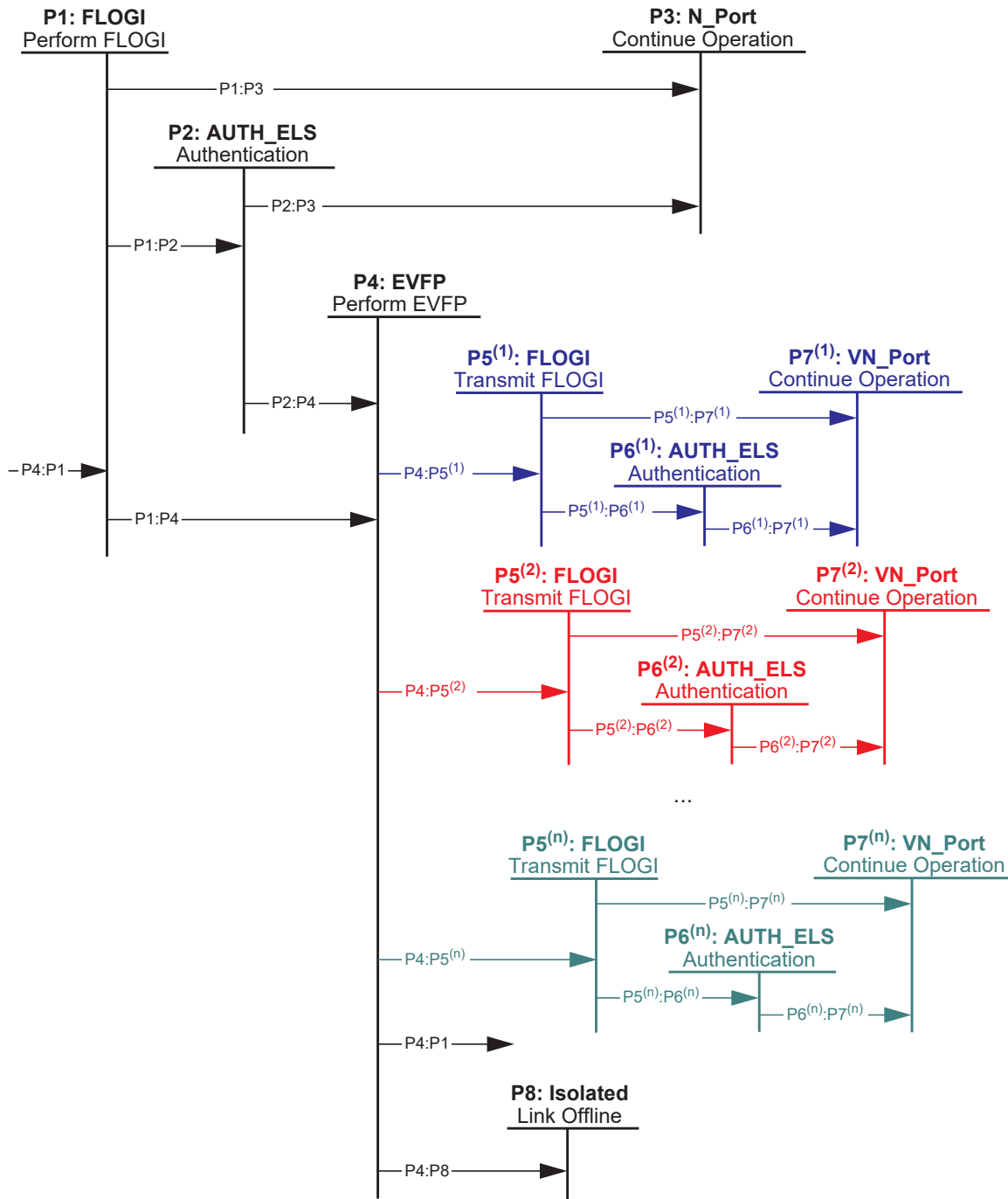

Figure 5 – PN\_Port Initialization of Virtual Fabrics

**State P1: FLOGI.** The PN\_Port performs FLOGI. The N\_Port\_Name of the VN\_Port to be associated with the Port VF\_ID shall be used by the PN\_Port in the FLOGI request; the Fabric\_Name of the Virtual Fabric associated with the Port VF\_ID shall be used by the PF\_Port in the FLOGI LS\_ACC.

**State P2: AUTH\_ELS.** In this state an Authentication transaction shall be performed (see FC-SP). The Virtual Fabrics bit may be set to one or to zero; the resulting behavior is as specified in table 208.

If the FLOGI LS\_ACC had the Virtual Fabrics bit set to one and the D\_ID set to 000000h, then the S\_ID of the AUTH\_ELS shall be the N\_Port Controller WKA, otherwise the S\_ID of the AUTH\_ELS shall be the assigned Address Identifier.

**State P3: N\_Port.** The N\_Port continues its operations. The PN\_Port may acquire additional N\_Port\_IDs by following the Additional N\_Port\_ID procedure.

**Transition P1:P2.** Occurs if the FLOGI LS\_ACC has the Security bit set to one.

**Transition P1:P3.** Occurs if the FLOGI LS\_ACC has both the Security bit and the Virtual Fabrics bit set to zero.

**Transition P2:P3.** Occurs if the Authentication transaction performed in state P2 completes successfully and the FLOGI LS\_ACC had the Virtual Fabrics bit set to zero.

**Transition P1:P4.** Occurs if the FLOGI LS\_ACC has the Security bit set to zero and the Virtual Fabrics bit set to one.

**Transition P2:P4.** Occurs if the Authentication transaction performed in state P2 completes successfully and the FLOGI LS\_ACC had the Virtual Fabrics bit set to one.

**State P4: Process EVFP.** The PN\_Port shall initiate the EVFP processing as described in 8.4.1.

**Transition P4:P5<sup>(k)</sup>.** Occurs if the EVFP processing determined that VFT tagging is performed. There is a different state for each Virtual Fabric negotiated to be used on the link. The state for Virtual Fabric K is denoted P5<sup>(k)</sup>.

**State P5<sup>(k)</sup>: FLOGI.** In this state the FC frames transmitted by the PN\_Port are tagged with the VFT\_Header carrying VF\_ID K. An FLOGI request, tagged with VF\_ID K, is transmitted. This FLOGI request shall carry the N\_Port\_Name of the VN\_Port associated with VF\_ID K and the operational parameters (e.g., timeout values, Classes of service) of Virtual Fabric K. The Virtual Fabrics bit shall be set to zero in this FLOGI request. The FLOGI LS\_ACC assigns an N\_Port\_ID in Virtual Fabric K to the VN\_Port associated with VF\_ID K. All parameters of the FLOGI request and the FLOGI LS\_ACC transmitted in this state are used as specified in clause 6, except that the following parameters in the Common Service Parameters are ignored and the values transmitted in state P1 are used instead:

- a) Buffer-to-buffer Credit (see 6.6.2.3);
- b) BB\_Credit Management (see 6.6.2.4.9);
- c) BB\_SC\_N (see 6.6.2.4.22); and
- d) Buffer-to-Buffer Receive Data\_Field Size (see 6.6.2.4.23).

**Transition P5<sup>(k)</sup>:P6<sup>(k)</sup>.** Occurs if the FLOGI processing in state P5 is completed, if the FLOGI LS\_ACC has the Security bit set to one.

**State P6<sup>(k)</sup>: AUTH\_ELS.** In this state the FC frames transmitted by the PN\_Port are tagged with the VFT\_Header carrying VF\_ID K. The VN\_Port associated with VF\_ID K performs an Authentication transaction (see FC-SP) in Virtual Fabric K, by using its N\_Port\_Name or any other appropriate identity. The corresponding VF\_Port authenticates by using the Switch\_Name of the Virtual Switch associated with VF\_ID K or any other appropriate identity.

**Transition P5<sup>(k)</sup>:P7<sup>(k)</sup>.** Occurs if the FLOGI processing in state P5 is completed, if the FLOGI LS\_ACC has the Security bit set to zero.

**Transition P6<sup>(k)</sup>:P7<sup>(k)</sup>.** Occurs if the Authentication transaction performed in state P6<sup>(k)</sup> completes successfully.

**State P7<sup>(k)</sup>: VN\_Port.** For VN\_Ports in this state the PN\_Port operates as VFT tagging PN\_Port. FC frames transmitted by the PN\_Port are tagged with the VFT\_Header carrying VF\_ID K. The VN\_Port continues its operations. The PN\_Port may acquire additional N\_Port\_IDs in Virtual Fabric K by following the additional N\_Port\_ID procedure, tagging the frames with a VFT\_Header carrying VF\_ID K.

**Transition P4:P1.** Occurs when the EVFP processing determined that VFT tagging is not performed and the PN\_Port and PF\_Port have the same Port VF\_ID. In state P1 the PN\_Port shall transmit an FLOGI request with the Virtual Fabrics bit set to zero, in order to acquire an N\_Port\_ID in the Virtual Fabric identified by the Port VF\_ID.

**Transition P4:P8.** Occurs if the EVFP processing determined that VFT tagging is not performed and the PN\_Port and PF\_Port do not have the same Port VF\_ID.

**State P8: Isolated.** In this state the PN\_Port is offline.

If VFT tagging is enabled on a link, a Link Reset (see FC-FS-3) shall not change the tagging process, while a Link Initialization (see FC-FS-3) shall stop the tagging process and reinitialize the link.

### 8.3 Configuration Information

A VF capable PN\_Port shall maintain the following configuration parameters:

- a) Tagging Administrative Status, used to negotiate the VFT tagging operational mode of the PN\_Port (see 4.3.38.2.2);
- b) Port VF\_ID (see 4.3.38.2.3); and
- c) Locally-Enabled VF\_ID List, used to negotiate the list of Virtual Fabrics operational over the PN\_Port (see 4.3.38.2.4).

### 8.4 Exchange Virtual Fabrics Parameters Processing

#### 8.4.1 Overview

The Exchange Virtual Fabrics Parameters ELS (EVFP) protocol allows a VF capable PN\_Port and a VF capable PF\_Port to:

- a) Negotiate the VFT Tagging operational mode;
- b) Verify the consistency of the two Port VF\_IDs; and
- c) Establish the list of operational Virtual Fabrics across the link.



An EVFP transaction occurs between an EVFP Initiator and an EVFP Responder. An EVFP transaction (see figure 6) is identified by a unique Transaction Identifier (T\_ID), and consists of a synchronizing phase (EVFP\_SYNC) followed by a commit phase (EVFP\_COMMIT).

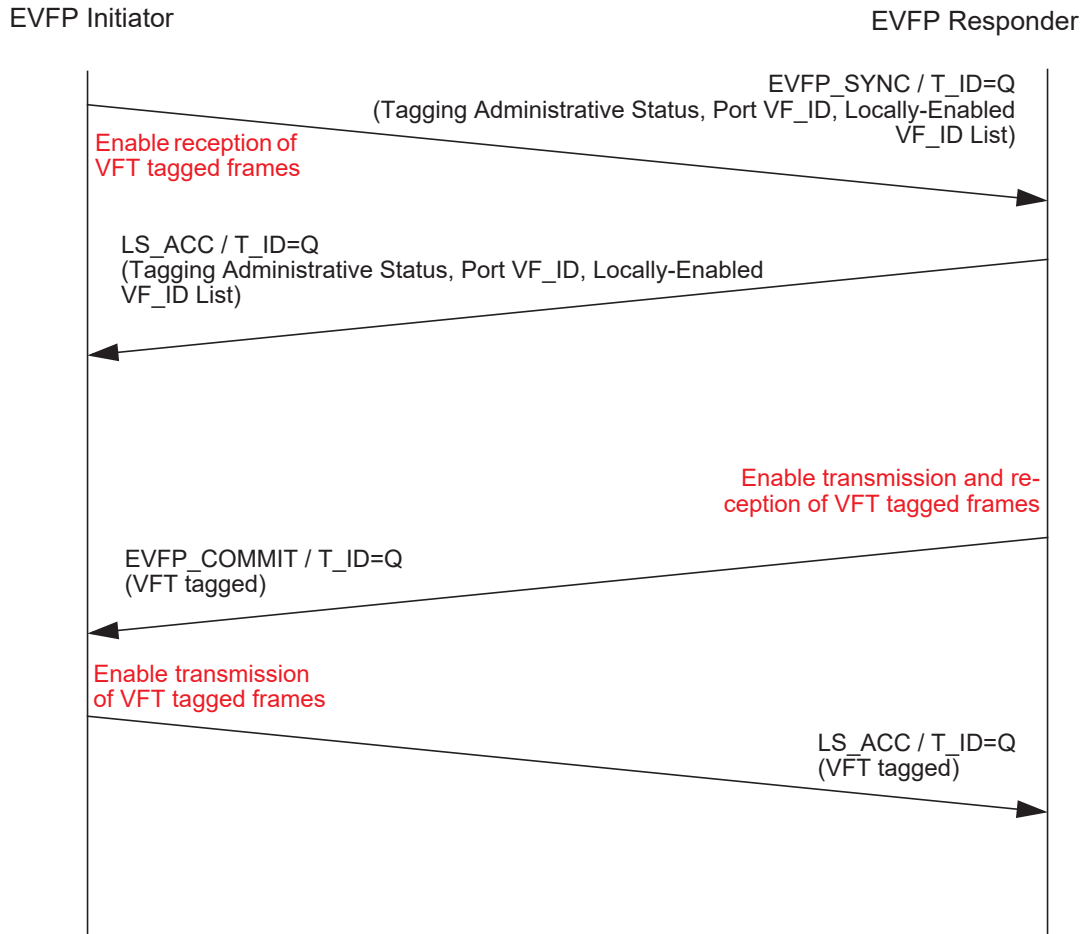

**Figure 6 – A Generic EVFP Transaction**

The VF\_ID value FEFh is used by the EVFP protocol for certain operations and is referred to as Control VF\_ID. The EVFP protocol, during the Initialization of Virtual Fabrics for a PN\_Port, proceeds as follows:

- 1) The EVFP Initiator shall start the EVFP transaction by sending the EVFP\_SYNC message (see 4.3.38.2) to the EVFP Responder. In the EVFP\_SYNC message, the EVFP Initiator shall specify the Transaction Identifier, and shall send its Core N\_Port\_Name if PN\_Port or its Core Switch\_Name if PF\_Port, together with its Tagging Administrative Status (see 4.3.38.2.2), Port VF\_ID (see 4.3.38.2.3) and Locally-Enabled VF\_ID List (see 4.3.38.2.4). On sending the EVFP\_SYNC message the EVFP Initiator enables the reception of VFT tagged frames;
- 2) The EVFP Responder shall reply with an LS\_ACC carrying its Core Switch\_Name if PF\_Port or its Core N\_Port\_Name if PN\_Port, together with its Tagging Administrative Status, Port VF\_ID and Locally-Enabled VF\_ID List. Then the EVFP Responder shall determine if VFT Tagging has to be enabled on the link, according to table 127. If VFT Tagging has to be enabled, the EVFP Responder shall go to step 3. If VFT Tagging has not to be enabled, the EVFP Responder shall check the received peer's Port VF\_ID:

- A) if the peer's Port VF\_ID is not equal to the local Port VF\_ID, on completion of the Exchange the EVFP protocol terminates and the EVFP Responder goes in Isolated state (transition P4:P8, see 8.2); or
- B) if the peer's Port VF\_ID is equal to the local Port VF\_ID, on completion of the Exchange the EVFP protocol terminates and the EVFP Responder goes in state P1 (transition P4:P1, see 8.2).

On receiving the EVFP\_SYNC LS\_ACC, the EVFP Initiator shall determine if VFT Tagging has to be enabled on the link, according to table 127. If VFT Tagging has to be enabled, on completion of the Exchange the EVFP Initiator shall go to step 4. If VFT Tagging has not to be enabled, the EVFP Initiator disables the reception of VFT tagged frames and shall check the received peer's Port VF\_ID:

- A) if the peer's Port VF\_ID is not equal to the local Port VF\_ID, on completion of the Exchange the EVFP protocol terminates and the EVFP Initiator goes in Isolated state (transition P4:P8, see 8.2); or
  - B) if the peer's Port VF\_ID is equal to the local Port VF\_ID, on completion of the Exchange the EVFP protocol terminates and the EVFP Initiator goes in state P1 (transition P4:P1, see 8.2);
- 3) On completion of the EVFP\_SYNC Exchange, the EVFP Responder shall enable both transmission and reception of VFT tagged frames for the Virtual Fabrics operational on the link, computed as explained in 4.2.56.2.4. Transmission and reception of VFT tagged frames for the Control VF\_ID shall be implicitly enabled. Transmission and reception of VFT tagged frames for the EVFP Initiator's Port VF\_ID shall be also enabled on the link, to allow a successful completion of the EVFP protocol. Then the EVFP Responder shall send an EVFP\_COMMIT message (see 4.2.56.3), tagged with the EVFP Initiator's Port VF\_ID; and
  - 4) On receiving the VFT tagged EVFP\_COMMIT, the EVFP Initiator shall enable both transmission and reception of VFT tagged frames for the Virtual Fabrics operational on the link, computed as explained in 4.2.56.2.4. Transmission and reception of VFT tagged frames for the Control VF\_ID shall be implicitly enabled. Transmission and reception of VFT tagged frames for the EVFP Initiator's Port VF\_ID shall be also enabled on the link, to allow a successful completion of the EVFP protocol. Then the EVFP Initiator shall send an EVFP\_COMMIT LS\_ACC message tagged with its Port VF\_ID.

If tagging is enabled the EVFP transaction completes successfully on completion of the EVFP\_COMMIT Exchange, for both the EVFP Initiator and EVFP Responder. If the computed set of VF\_IDs operational on the link does not include the EVFP Initiator's Port VF\_ID, transmission and reception of VFT tagged frames for such VF\_ID shall be disabled on the link upon completion of the EVFP transaction. If the EVFP transaction is completed the processing continues independently for each Virtual Fabric operational on the link, as shown by transitions P4:P5(k) (see 8.2). If the computed set of VF\_IDs operational on the link is NULL, the involved FC\_Ports remain in state P4 (see 8.2) until a new EVFP transaction is performed in the Control VF\_ID.

If an PN\_Port and an PF\_Port start an EVFP transaction at the same time, or if an FC\_Port is acting as an EVFP Initiator and receives an EVFP\_SYNC message from the designated EVFP Responder, one of the two EVFP transactions shall be aborted. The PN\_Port shall remain the EVFP Initiator, while the PF\_Port shall become the EVFP Responder. The FC\_Port that remains the EVFP Initiator shall reply to the received EVFP\_SYNC message with an 'EVFP collision' LS\_RJT (see 4.3.38.1.2). The FC\_Port that becomes the EVFP Responder shall reply to the received EVFP\_SYNC message and abort its own transaction upon receipt of the LS\_RJT.

The EVFP protocol is used also if some PN\_Port or PF\_Port configuration information (see 8.3) is changed by a management action. The EVFP messages may be carried in FC frames tagged with the Port VF\_ID if the EVFP protocol begins while the link is not performing VFT tagging (see 8.4.1). The EVFP messages are carried in FC frames tagged with the Control VF\_ID if the EVFP protocol begins while the link is performing VFT tagging (see 8.4.2 and 8.4.3).

#### 8.4.2 Changing the VFT Tagging Mode

If a management action changes the Administrative Tagging Mode of a VF capable PN\_Port or VF capable PF\_Port that determined during initialization the peer supports the EVFP protocol, the FC\_Port shall determine if the link has to change its VFT Tagging mode (i.e., if it has to transition from tagging to untagging mode or from untagging to tagging mode) by acting as EVFP Initiator as follows. If the PN\_Port or PF\_Port is currently performing tagging, all EVFP protocol messages shall be tagged with the Control VF\_ID. If the PN\_Port or PF\_Port is currently not performing tagging, all EVFP protocol messages shall be untagged.

- 1) The EVFP Initiator shall start the EVFP transaction by sending the EVFP\_SYNC message to the EVFP Responder. The EVFP\_SYNC message shall carry the updated Tagging Administrative Status (see 4.3.38.2.2), Port VF\_ID, and the Locally-Enabled VF\_ID List; and
- 2) The EVFP Responder shall reply with an LS\_ACC carrying its Tagging Administrative Status, Port VF\_ID and Locally-Enabled VF\_ID List. The EVFP Responder shall determine if VFT Tagging has to be changed on the link, according to table 127. The EVFP Responder:
  - A) if VFT Tagging has not to be changed, on completion of the Exchange terminates the EVFP protocol; or
  - B) if VFT Tagging has to be changed, on completion of the Exchange shall perform a link initialization.

On receiving the EVFP\_SYNC LS\_ACC, the EVFP Initiator shall determine if VFT Tagging has to be changed on the link, according to table 127. The EVFP Initiator:

- A) if VFT Tagging has not to be changed, on completion of the Exchange terminates the EVFP protocol; or
- B) if VFT Tagging has to be changed, shall participate in the link initialization initiated by the EVFP Responder.

#### 8.4.3 Adding or Removing Virtual Fabrics

If a management action changes the Locally-Enabled VF\_ID List of a tagging PN\_Port or tagging PF\_Port, the FC\_Port shall initiate the EVFP protocol by acting as EVFP Initiator as follows. All EVFP protocol messages shall be tagged with the Control VF\_ID.

- 1) The EVFP Initiator shall start the EVFP transaction by sending the EVFP\_SYNC message to the EVFP Responder. The EVFP\_SYNC message shall carry the Tagging Administrative Status, Port VF\_ID, and the updated Locally-Enabled VF\_ID List (see 4.3.38.2.4);
- 2) The EVFP Responder shall reply with an LS\_ACC carrying its Tagging Administrative Status, Port VF\_ID and Locally-Enabled VF\_ID List. The EVFP Responder, depending on the resulting operational VF\_ID List (see 4.3.38.2.4):

- A) if the operational VF\_ID List did not change, on completion of the Exchange in the Control VF\_ID terminates the EVFP protocol; or
- B) if the operational VF\_ID List did change, on completion of the Exchange in the Control VF\_ID goes to step 3.

On receiving the EVFP\_SYNC LS\_ACC in the Control VF\_ID, the EVFP Initiator, depending on the resulting operational VF\_ID List:

- A) if the operational VF\_ID List did not change, on completion of the Exchange in the Control VF\_ID terminates the EVFP protocol; or
  - B) if the operational VF\_ID List did change, on completion of the Exchange in the Control VF\_ID goes to step 4.
- 3) On completion of the EVFP\_SYNC Exchange in the Control VF\_ID, the EVFP Responder shall apply the updated operational VF\_ID List, enabling the added Virtual Fabrics and disabling the removed Virtual Fabrics. The removal of a Virtual Fabric should be treated as an implicit logout. Then the EVFP Responder shall send an EVFP\_COMMIT message; and
  - 4) On receiving the EVFP\_COMMIT message, the EVFP Initiator shall apply the updated operational VF\_ID List, enabling the added Virtual Fabrics and disabling the removed Virtual Fabrics. The removal of a Virtual Fabric should be treated as an implicit logout. Then the EVFP Initiator shall send an EVFP\_COMMIT LS\_ACC message.

If the operational VF\_ID List changes, the EVFP transaction completes successfully on completion of the EVFP\_COMMIT Exchange for both the EVFP Initiator and EVFP Responder. If the EVFP transaction is completed, the updated operational VF\_ID List is operative.

#### **8.4.4 Changing the Port VF\_ID**

If a management action changes the Port VF\_ID of a tagging PN\_Port or tagging PF\_Port, no changes are applied to the link.

If a management action changes the Port VF\_ID of a non tagging PN\_Port or tagging PF\_Port, the FC\_Port shall perform a link initialization.

If a management action changes the Port VF\_ID of a PN\_Port or PF\_Port in Isolated state (i.e., state P8), the FC\_Port shall go in state P1 (see 8.2).

## 9 Priority Tagging

### 9.1 Overview

The Priority Tagging mechanism uses values of the Priority field in the Fibre Channel header as VE identifiers local to an N\_Port\_ID of a Virtual Entities Manager (VEM). The VEM tags the traffic of a specific VE with an 8-bit local VE ID that is in the Priority field of the FC header. This enables the Fabric and the devices to identify, monitor, and handle FC traffic based on VE tags.

Figure 7 shows the relationship among local VE IDs (VEs), N\_Port\_IDs (VN\_Ports) and physical ports (PN\_Ports) in a system supporting server virtualization. Each PN\_Port is able to instantiate multiple VN\_Ports through the NPIV mechanism. Each VN\_Port has its own N\_Port\_ID and is able to identify multiple VEs through local VE ID values (i.e., values local to the VN\_Port's N\_Port\_ID). The pair {VN\_Port's N\_Port\_ID, Local VE ID} is the Fabric VE ID of a specific VE.

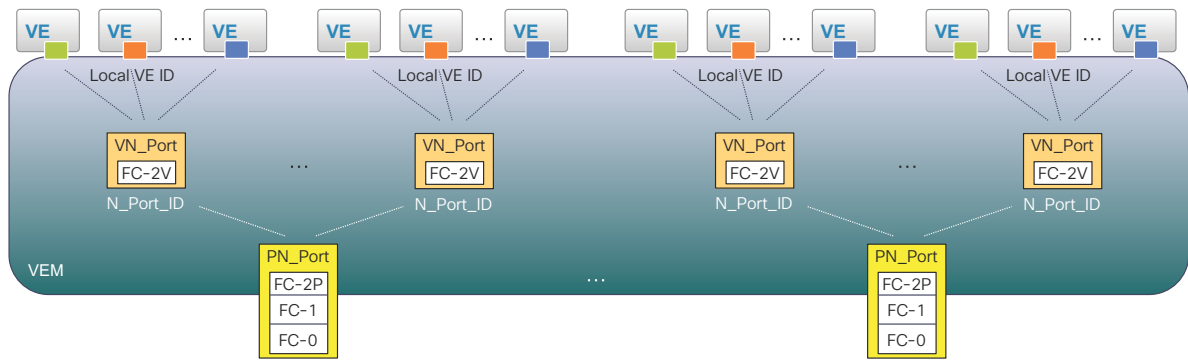

**Figure 7 – Example of Relationship among Local VE IDs, N\_Port\_IDs, and PN\_Ports**

Devices and the Fabric are able to identify the traffic of a specific VE through the Fabric VE ID. The Fabric maintains the mapping between global VE IDs and Fabric VE IDs through the VE Identification Server (see FC-GS-8). Table 209 shows the mappings maintained by the VE Identification Server.

**Table 209 – VE Identification Server Mappings**

Global VE ID	Fabric VE ID	
Global VE ID #1	N_Port_ID #1	Local VE ID #1
Global VE ID #2	N_Port_ID #2	Local VE ID #2
...		
Global VE ID #n	N_Port_ID #n	Local VE ID #n

Figure 8 shows an example of VE traffic identification using the Priority Tagging mechanism.

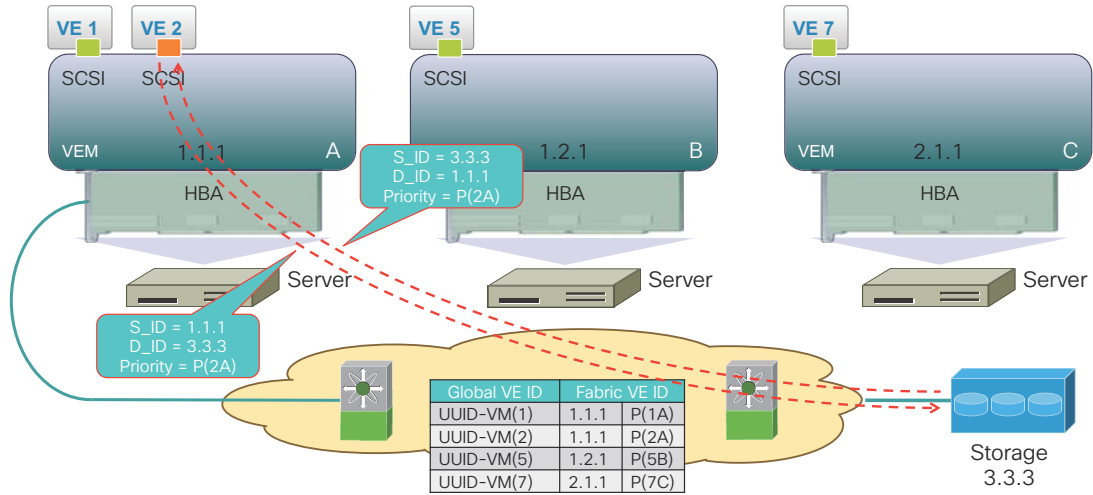

**Figure 8 – Example of Priority Tagging of the Traffic of a VE**

As shown in figure 8, the VE Identification Server maps the global VE IDs of VEs 1, 2, 5, and 7 into their respective Fabric VE IDs. For example, the FC frames that VE 2 originates to the storage are identified by their S\_ID and Priority field value and the FC frames that it receives from the storage are identified by their D\_ID and Priority field value (i.e., the Fabric VE ID of VE 2). A query to the VE Identification Server enables the resolution of the Fabric VE ID of VE 2 into its global VE ID.

The VE Identification Server mappings are updated by the VEMs. Each time a VE is instantiated, de-instantiated, or moved, the involved VEM(s) shall update the VE Identification Server accordingly, to keep the mapping information current.

## 9.2 Operations

Support for the Priority Tagging mechanism shall be indicated via the Priority Tagging Supported bit in the Login Common Service Parameters (see 6.6.2.4.15).

An N\_Port supporting Priority Tagging (i.e., setting to one the Priority Tagging Supported bit in the FLOGI request) and the instantiation of VEs, upon completing FLOGI with a Switch also supporting Priority Tagging (i.e., setting to one the Priority Tagging Supported bit in the FLOGI LS\_ACC) shall inquire the Fabric about the Priority field values useable as local VE IDs through the QFPA ELS (see 4.3.49). The QFPA LS\_ACC provides to the N\_Port the ranges of Priority field values useable as local VE IDs and the QoS priority processing the Fabric provides for each range. The N\_Port may use the available Priority field values in the manner that it deems appropriate. Priority field value zero shall not be used as a local VE ID for VEs that require traffic identification.

Upon instantiating a VE, an N\_Port supporting Priority Tagging shall select one of the available Priority field values as the local VE ID for that VE and update the VE Identification Server by registering with the Fabric the correspondent global VE ID to Fabric VE ID mapping using a UVEM ELS (see 4.3.50). If the N\_Port is logged in to a device that supports Priority Tagging (i.e., a device that set to one the Priority Tagging Supported bit in the PLOGI LS\_ACC), then the N\_Port should notify the device about the instantiated VE by registering with the device the correspondent global VE ID to Fabric VE ID mapping using a UVEM ELS.

Upon deinstantiating a VE, an N\_Port supporting Priority Tagging shall deselect the local VE ID for that VE and update the VE Identification Server by deregistering with the Fabric the correspondent global VE ID to Fabric VE ID mapping using a UVEM ELS. If the N\_Port is logged in to a device that supports Priority Tagging (i.e., a device that set to one the Priority Tagging Supported bit in the PLOGI LS\_ACC), then the N\_Port should notify the device about the deinstantiated VE by deregistering with the device the correspondent global VE ID to Fabric VE ID mapping using a UVEM ELS.

A VE move from one N\_Port to another is handled as a VE deinstantiation on the origin N\_Port and a VE instantiation on the destination N\_Port.

### **9.3 Scalability**

Priority field values enable a VEM to identify the traffic of up to 255 VEs per VN\_Port. A PN\_Port may instantiate multiple VN\_Ports (i.e., acquire additional N\_Port\_IDs) through NPIV if the traffic of more than 255 VEs need to be identified. Large systems supporting many VEs are usually equipped with multiple N\_Ports, each providing the ability to identify up to 255 VEs (see figure 7).

If a VE does not require traffic identification, then the value zero shall be used as its local VE ID.

Multiple VEs may use the same local VE ID. If the same local VE ID is used by multiple VEs then those VEs are identified as a group and their individual traffic is not able to be identified.